



Setup Manual

DuraVision® DX0212-IP

IP Decoding Box

Software Version 6.2

Important

Please read this "Setup Manual", and "PRECAUTIONS" (separate volume) carefully to familiarize yourself with safe and effective usage.

Please retain this manual for future reference.

-
- For the latest product information including the "Setup Manual", refer to our web site :
www.eizoglobal.com
-

Location of Caution Statement

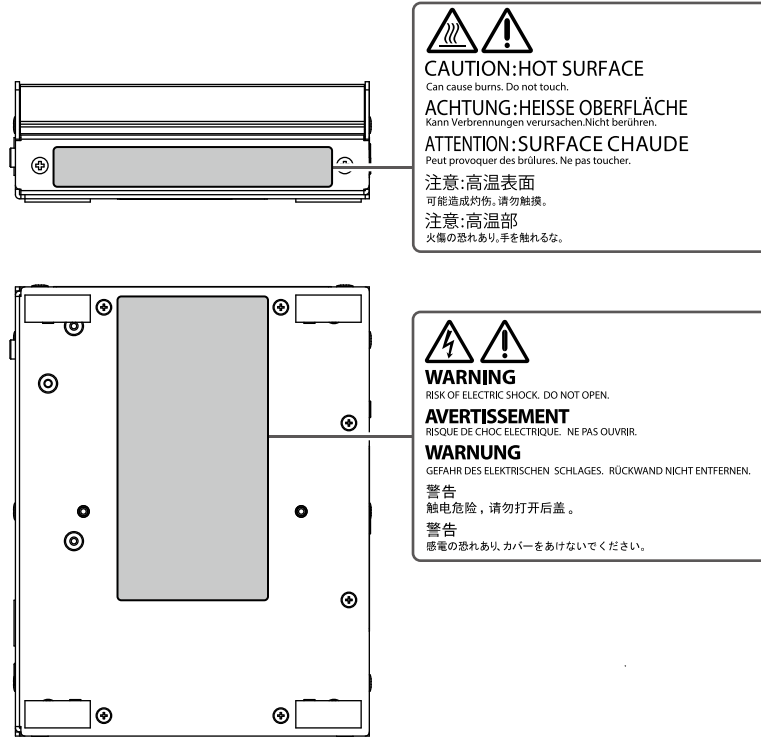

This product has been adjusted specifically for use in the region to which it was originally shipped. If operated outside this region, the product may not perform as stated in the specifications.

No part of this manual may be reproduced, stored in a retrieval system, or transmitted, in any form or by any means, electronic, mechanical, or otherwise, without the prior written permission of EIZO Corporation. EIZO Corporation is under no obligation to hold any submitted material or information confidential unless prior arrangements are made pursuant to EIZO Corporation's receipt of said information. Although every effort has been made to ensure that this manual provides up-to-date information, please note that EIZO product specifications are subject to change without notice.

Notice for this product

About the Usage of This Product

This product is a device that outputs video images from network cameras to a monitor connected using HDMI cable.

If using this product for the following kinds of applications, where an extremely high degree of reliability and safety is required, then measures should be in place to maintain safety while using this product.

- Transportation equipment (ships, aircraft, trains, and automobiles)
 - Safety devices (Disaster prevention systems, security control systems, etc.)
 - Life-critical devices (medical devices, such as life-support devices and operating room devices)
 - Nuclear energy control devices (Nuclear energy control systems, security control systems of nuclear facilities, etc.)
 - Major system communication devices (operation control systems of transportation systems, air traffic control systems, etc.)
-

This product has been adjusted specifically for use in the region to which it was originally shipped. If the product is used outside the region, it may not operate as specified in the specifications.

This product may not be covered by warranty for uses other than those described in this manual.

The specifications noted in this manual are only applicable when using the AC adapters and signal cables specified by EIZO.

Only use optional products manufactured or specified by us with this product.

About the Installation

If this product is placed on a lacquer-finished desk, the color may adhere to the bottom of the product due to the composition of the rubber. Check the desk surface before use.

When the product is cold and brought into a room or the room temperature goes up quickly, dew condensation may occur on the interior and exterior surfaces of the product. In that case, do not turn the product on. Instead wait until the dew condensation disappears, otherwise it may cause some damage to the product.

Install this product on a stable surface such as a desk with its flat surface as the bottom in a horizontal orientation.

This product can be mounted on the monitor by using a special mounting bracket (separately sold option).

The mounting bracket can be purchased from our web site.

www.eizoglobal.com

With respect to the installation orientation when the mounting bracket is used, refer to the instruction sheet of the mounting bracket.

Cleaning

- Periodic cleaning is recommended to keep the product looking new and to prolong its operation lifetime.
- Stains on the product can be removed by moistening part of a soft cloth with water or by using our ScreenCleaner and gently wiping.

Attention

- Do not let liquids come into direct contact with the product. If it does, wipe it off immediately.
- Do not allow liquids to get into gaps or inside the product.
- When using chemicals for cleaning or disinfection, chemicals such as alcohol and disinfectant may cause gloss variation, tarnishing, and fading of the product, and also quality deterioration of the displayed image. Do not use chemicals on a frequent basis.
- Never use a thinner, benzene, wax, or abrasive cleaner as they may damage the product.
- For more information on cleaning and disinfection, please refer to our web site.

How to check: Access www.eizoglobal.com and type “disinfect” in the site search box to search.

Disclaimer

Our company shall bear no responsibility for any damage (including lost profits, etc.) incurred directly or indirectly by using this product or by malfunctions, etc. (including, but not limited to, those caused by the following).

1. Misuse or carelessness by the customer
2. Disassembly, repair, or modification by the customer
3. Inability to display images due to some reason or cause including malfunction or failure of this product
4. Use of the product in combination with a third-party device
5. Occurrence of an event such as infringement of privacy due to some cause with respect to the images monitored by the customer
6. Loss of registered or recorded information due to some cause

While this product displays camera surveillance images, the use of this product alone does not directly prevent crime.

Network Security Request

Because this product is used by connecting to networks, the following risks apply

1. Leakage of information through this product.
2. Unauthorized operation of this product by a malicious third party.
3. Interference or suspension of the use of this product by a malicious third party.

In order to prevent the above described damage, it is the user's responsibility to implement adequate network security measures including the measures described below.

- Use this product with a safety-ensured network by using a firewall or other network security systems.
- Change the administrator password periodically.

Contents

Notice for this product	3	4-5. Checking a Camera Connection with Ping	33
Cleaning	4	4-6. Checking for Duplicate IP Addresses	34
Disclaimer	4	4-7. Checking the IP Address of a Computer ...	34
Network Security Request	4	Appendix	35
Contents	5	Warning for Radio interference.....	35
Chapter 1 Introduction	6	LIMITED WARRANTY	36
1-1. Package Contents	6		
1-2. Controls and Functions	7		
1-3. System Configuration	8		
● Camera (Network camera).....	8		
● Network hub	8		
● Network cable	9		
● USB mouse	9		
● Computer.....	9		
● Video display monitor	10		
Chapter 2 Setup	11		
2-1. What to prepare	11		
2-2. Setting Cameras	11		
● Username and Password.....	11		
● Date and time	11		
● IP Address.....	11		
● Stream.....	12		
2-3. Connecting Devices	14		
2-4. Turn on the Power and Display the Live Image Screen	15		
2-5. Displaying the Setting Screen	16		
● When Using the Monitor Console	16		
● When Using the Web Console.....	17		
2-6. Setting the Date and Time	18		
2-7. Setting the IP Address	19		
● Network Settings.....	19		
2-8. Configuring the Language	19		
2-9. Registering a Camera Using Auto Discovery	20		
2-10. Preparing the Remote Control	21		
Chapter 3 Other Settings	22		
3-1. Updating software	22		
3-2. Registering a license	22		
3-3. Save and Load Settings Data to Other Products	23		
3-4. Registering a Camera Manually	24		
Chapter 4 Troubleshooting	28		
4-1. Power Problems	28		
4-2. Camera Registration Problems	29		
4-3. Video Problems	30		
4-4. Other Problems	33		

Chapter 1 Introduction

This chapter describes the settings required for displaying camera (network camera) images on the monitor.

1-1. Package Contents

Check that all of the following parts are included. If any of these are missing or damaged, contact your dealer or local EIZO representative.

- DX0212-IP (this product)
- Setup Manual
- HDMI cable (HDMI - HDMI, 0.5 m)
HH050HS
- Precautions

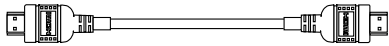

- Mounting screws of PCSK-03 / PCSK-03R
Used for mounting the PCSK-03 or PCSK-03R adapter for smaller devices.

Note

- It is recommended that the packing box and materials be kept for future usage such as for moving or transporting the product.
-

1-2. Controls and Functions

Front

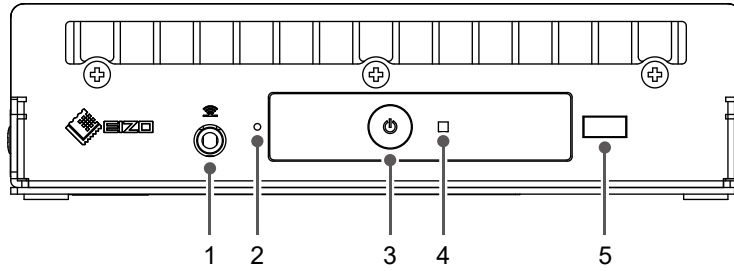

Names	Details	
1. Connection terminal for remote control receiver unit	If the remote control receiver unit cannot be used due to the installation location, use the remote control receiver cable to connect the receiver unit. When using the remote control receiver unit, the remote control receiver on the main unit is disabled.	
2. Reset button	Pressing and holding this button for 10 seconds will initialize the following information: <ul style="list-style-type: none"> • Camera information • USB lock • User account setting 	
3. Power button	Turns the power on or off.	
4. Power indicator	Displays the operating status of the product.	
	Blue	Normal operating mode
	Flashing blue	Starting up
	Red	Power off
OFF	Main power off	
5. Remote control light reception section	Receives signals from the remote control. For details on the receiver range, refer to the User's Manual.	

Back

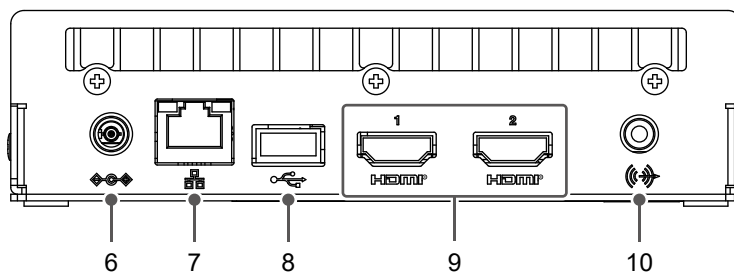

Names	Details			
6. DC input	Connects the AC adapter (sold separately).			
7. LAN port	Connects the network cable. Inputs power when connected to a network hub that supports PoE.			
		a) Status LED	Orange	Powered is supplied through the PoE+
			OFF	Powered is supplied through the AC adapter
		b) Link LED	Green	Network connection established
		OFF	Network connection not established	

8. USB downstream port	Connects a USB mouse, USB keyboard, or joystick.
9. HDMI1 / HDMI2	HDMI output connector. Connects to monitors that support HDMI.
10. Stereo mini jack	This terminal emits the beep sound of the product main unit. Connects a commercially available stereo mini jack cable. This terminal does not support the audio output of network cameras.

1-3. System Configuration

This product is used by connecting to a network.

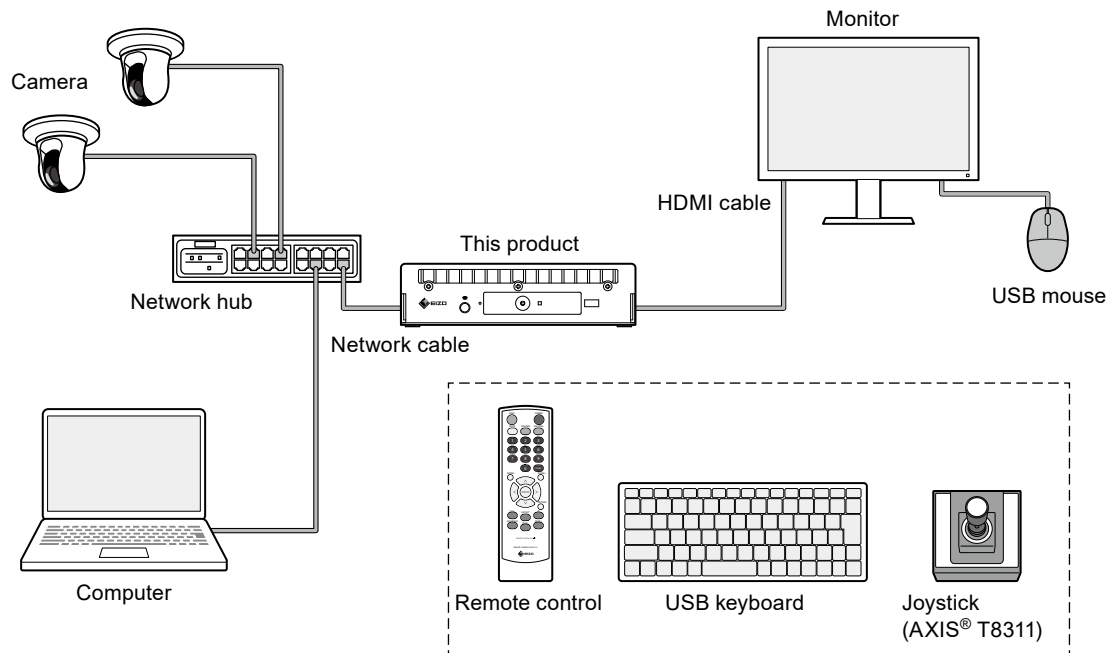

● Camera (Network camera)

Panasonic/i-PRO, Axis, or ONVIF® Profile S compliant cameras

Attention

Camera compatibility

- In addition to displaying video, this product supports PTZ control and setting changes of cameras. However, not all functions may be available due to reasons such as the required API not being provided. For functions that are not available from this product or do not work as expected, please operate them on the camera side.
- If you need to control the PTZ settings of the camera from this product, please refer to the compatibility information of verified cameras.



www.eizoglobal.com/support/db/products/model/DX0212-IP

● Network hub

100BASE-T / 100BASE-TX compatible network hub

This product supports PoE+. When supplying power using a network cable, use a PoE-compatible network hub.

ONVIF is a trademark of ONVIF Inc.

Note

- When using an AC adapter (sold separately), the network hub does not need to support PoE+ (when supplying power to the camera using a network cable, it must support PoE).
-

● Network cable

Category 5e or higher straight cable

● USB mouse

Used to control the live image screen and setting screen.

Attention

- Only the live image screen can be controlled with the remote control.
-

● Computer

Used to configure this product and cameras. After configuring, it can be removed from the network. The following settings are available only if you are using a computer.

- Entering characters other than alphanumeric characters and symbols in the camera name
- Updating software
- Registering a license
- Saving/loading system information

If your computer does not have a LAN port, consider using a USB LAN adapter.

Note

IP address

- Since an IP address corresponds to an address on the network, each device must be set with a unique IP address (see “2-7. Setting the IP Address” (page 19)). If an IP address that overlaps with another device is set, communication will not work properly.

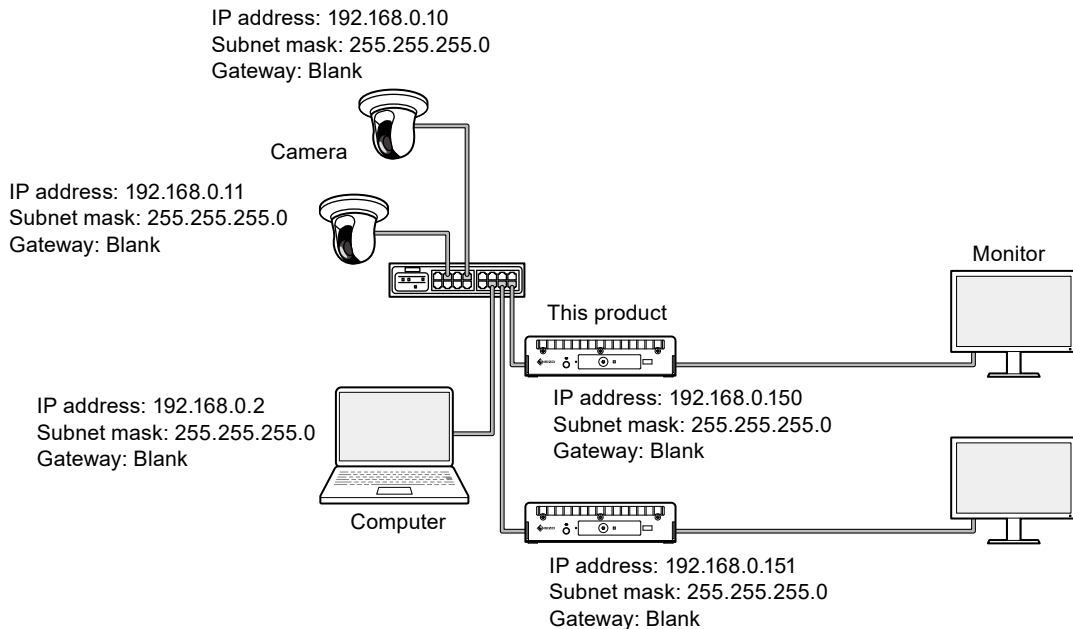

- If your network environment does not include a gateway (default gateway), you do not need to set the “Gateway” address.
 - The default IP address of this product is “192.168.0.150”. When installing multiple units, set unique IP addresses (refer to “4-6. Checking for Duplicate IP Addresses” (page 34)).
-

● Video display monitor

Connect to the product with an HDMI cable to display camera images. Use a monitor that supports HDMI and can display the output resolution of this product. For information on the output resolution, refer to the User's Manual.

Chapter 2 Setup

2-1. What to prepare

Prepare a USB mouse and computer.

If you do not have an Internet connection from your work location, please have the following files on your computer in advance.

File	Where to get
Set of user manuals <ul style="list-style-type: none">• Setup Manual (this document)• User's Manual	 Please download the necessary files from "Downloads" on the above page.
Latest version of system software	
License file	Additional features are available with the purchase of a license. For details on features, refer to the User's Manual. For details on purchasing a license, contact your dealer or local EIZO representative.

2-2. Setting Cameras

To use this product to display camera images, cameras must be set up in advance.

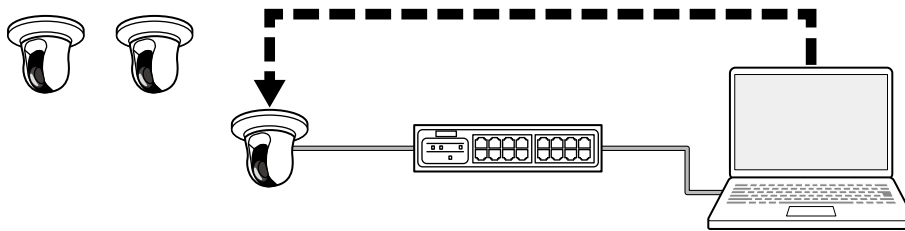

Refer to the User's Manual of the camera and make the following settings.

- **Username and Password**

Set a password of up to 32 characters using alphanumeric characters and symbols for a user with administrative privileges.

- **Date and time**

Select a time zone and set the correct date and time.

- **IP Address**

Set an IP address that does not overlap with another device.

- **Stream**

Set the stream to match the display performance of this product.

- Check if the stream is enabled.
- When using the “Panasonic/i-PRO” protocol, it connects to stream 2 by default.

Item	Description																								
Video compression format	Select the video compression format according to the “protocol” used for camera registration. “Panasonic/i-PRO”: H.265 or H.264 “AXIS”: H.265 or H.264 “ONVIF”: H.265, H.264 or MJPEG Note <ul style="list-style-type: none"> • For the latest operating status for H.265, refer to the camera compatibility information on the EIZO website. 																								
Bit rate	Set the value to 8192 kbps or less. (4096 kbps recommended)																								
Resolution / Frame rate	Set the resolution and frame rate according to the number of cameras to be simultaneously displayed on the live image screen. H.265 / H.264 (when “Bit rate” is set to “4096 kbps”) Video display monitor resolution is 1920 x 1080, 60 Hz <table border="1" data-bbox="520 842 1430 1077"> <tr> <td>1 screen layout</td> <td>3840 x 2160 / 30 fps, 1920 x 1080 / 60 fps, 1280 x 720 / 60 fps</td> </tr> <tr> <td>4 screen layout</td> <td>3840 x 2160 / 20 fps, 1920 x 1080 / 60 fps, 1280 x 720 / 60 fps</td> </tr> <tr> <td>9 screen layout</td> <td>1920 x 1080 / 30 fps, 1280 x 720 / 50 fps, 640 x 480 / 60 fps</td> </tr> <tr> <td>12 screen layout</td> <td>1920 x 1080 / 20 fps, 1280 x 720 / 40 fps, 640 x 480 / 60 fps</td> </tr> <tr> <td>16 screen layout</td> <td>1920 x 1080 / 20 fps, 1280 x 720 / 30 fps, 640 x 480 / 50 fps</td> </tr> <tr> <td>32 screen layout</td> <td>1280 x 720 / 15 fps, 640 x 480 / 30 fps</td> </tr> </table> Video display monitor resolution is 3840 x 2160, 60 Hz <table border="1" data-bbox="520 1126 1430 1361"> <tr> <td>1 screen layout</td> <td>3840 x 2160 / 30 fps, 1920 x 1080 / 30 fps, 1280 x 720 / 30 fps</td> </tr> <tr> <td>4 screen layout</td> <td>3840 x 2160 / 20 fps, 1920 x 1080 / 30 fps, 1280 x 720 / 30 fps</td> </tr> <tr> <td>9 screen layout</td> <td>1920 x 1080 / 25 fps, 1280 x 720 / 30 fps, 640 x 480 / 30 fps</td> </tr> <tr> <td>12 screen layout</td> <td>1920 x 1080 / 20 fps, 1280 x 720 / 25 fps, 640 x 480 / 30 fps</td> </tr> <tr> <td>16 screen layout</td> <td>1920 x 1080 / 20 fps, 1280 x 720 / 25 fps, 640 x 480 / 30 fps</td> </tr> <tr> <td>32 screen layout</td> <td>1280 x 720 / 15 fps, 640 x 480 / 20 fps</td> </tr> </table> MJPEG 640 × 480 / 30 fps Attention <ul style="list-style-type: none"> • The values above are provided for reference purposes. • If the stream exceeds the display capabilities of this product, the frame rate of the camera video will be forced down. Reduce the resolution and/or bit rate. 	1 screen layout	3840 x 2160 / 30 fps, 1920 x 1080 / 60 fps, 1280 x 720 / 60 fps	4 screen layout	3840 x 2160 / 20 fps, 1920 x 1080 / 60 fps, 1280 x 720 / 60 fps	9 screen layout	1920 x 1080 / 30 fps, 1280 x 720 / 50 fps, 640 x 480 / 60 fps	12 screen layout	1920 x 1080 / 20 fps, 1280 x 720 / 40 fps, 640 x 480 / 60 fps	16 screen layout	1920 x 1080 / 20 fps, 1280 x 720 / 30 fps, 640 x 480 / 50 fps	32 screen layout	1280 x 720 / 15 fps, 640 x 480 / 30 fps	1 screen layout	3840 x 2160 / 30 fps, 1920 x 1080 / 30 fps, 1280 x 720 / 30 fps	4 screen layout	3840 x 2160 / 20 fps, 1920 x 1080 / 30 fps, 1280 x 720 / 30 fps	9 screen layout	1920 x 1080 / 25 fps, 1280 x 720 / 30 fps, 640 x 480 / 30 fps	12 screen layout	1920 x 1080 / 20 fps, 1280 x 720 / 25 fps, 640 x 480 / 30 fps	16 screen layout	1920 x 1080 / 20 fps, 1280 x 720 / 25 fps, 640 x 480 / 30 fps	32 screen layout	1280 x 720 / 15 fps, 640 x 480 / 20 fps
1 screen layout	3840 x 2160 / 30 fps, 1920 x 1080 / 60 fps, 1280 x 720 / 60 fps																								
4 screen layout	3840 x 2160 / 20 fps, 1920 x 1080 / 60 fps, 1280 x 720 / 60 fps																								
9 screen layout	1920 x 1080 / 30 fps, 1280 x 720 / 50 fps, 640 x 480 / 60 fps																								
12 screen layout	1920 x 1080 / 20 fps, 1280 x 720 / 40 fps, 640 x 480 / 60 fps																								
16 screen layout	1920 x 1080 / 20 fps, 1280 x 720 / 30 fps, 640 x 480 / 50 fps																								
32 screen layout	1280 x 720 / 15 fps, 640 x 480 / 30 fps																								
1 screen layout	3840 x 2160 / 30 fps, 1920 x 1080 / 30 fps, 1280 x 720 / 30 fps																								
4 screen layout	3840 x 2160 / 20 fps, 1920 x 1080 / 30 fps, 1280 x 720 / 30 fps																								
9 screen layout	1920 x 1080 / 25 fps, 1280 x 720 / 30 fps, 640 x 480 / 30 fps																								
12 screen layout	1920 x 1080 / 20 fps, 1280 x 720 / 25 fps, 640 x 480 / 30 fps																								
16 screen layout	1920 x 1080 / 20 fps, 1280 x 720 / 25 fps, 640 x 480 / 30 fps																								
32 screen layout	1280 x 720 / 15 fps, 640 x 480 / 20 fps																								

Note**Camera stream**

Typically, cameras support multiple streams and can transmit video at different resolutions and frame rates simultaneously.

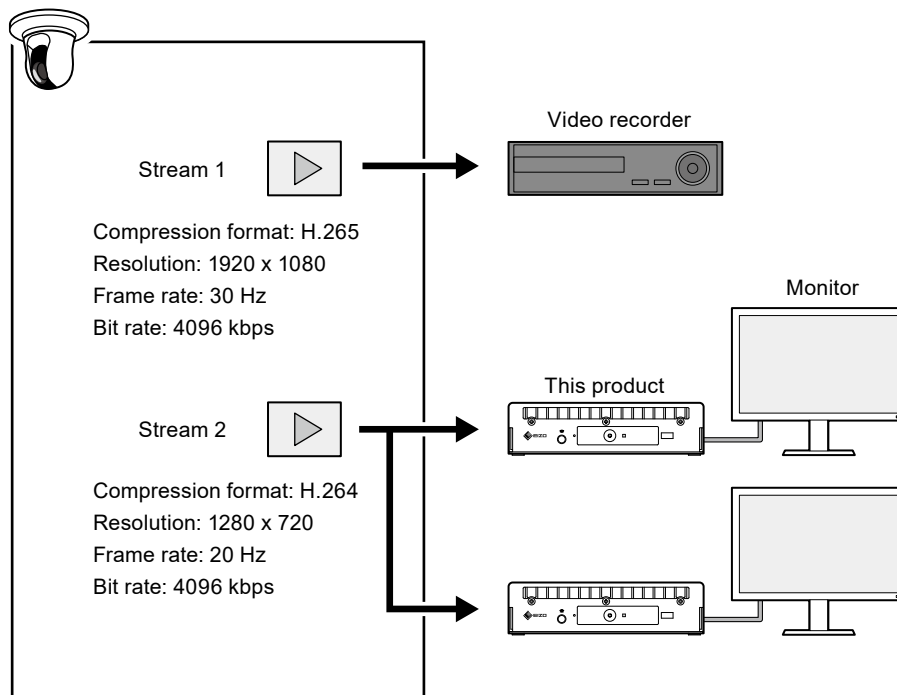

- By separating stream 1 for recording and stream 2 for live image viewing, you can prevent changes in stream settings from affecting other devices.
 - When registering a camera with “Panasonic/i-PRO” protocol, it connects to stream 2 by default.
 - The stream to connect to can be changed by manual registration (refer to “3-4. Registering a Camera Manually” (page 24)).
-

2-3. Connecting Devices

Note

- This product supports PoE+. If the network hub supports PoE+, power is supplied from the network hub, so connecting an AC adapter is not required.
- If the network hub does not support PoE+, use an AC adapter (sold separately). Please follow the procedure below to make the connection.
 1. Connect the power cord to the AC adapter.
 2. Connect the output terminal of the AC adapter to the DC input terminal of the product (insert it firmly all the way in).
 3. Connect the power plug to the power outlet.
- When the AC adapter is used while connected to a network hub that supports PoE+ compatible, power is supplied from the AC adapter.

1. Connect this product and the cameras to a network hub with network cables.

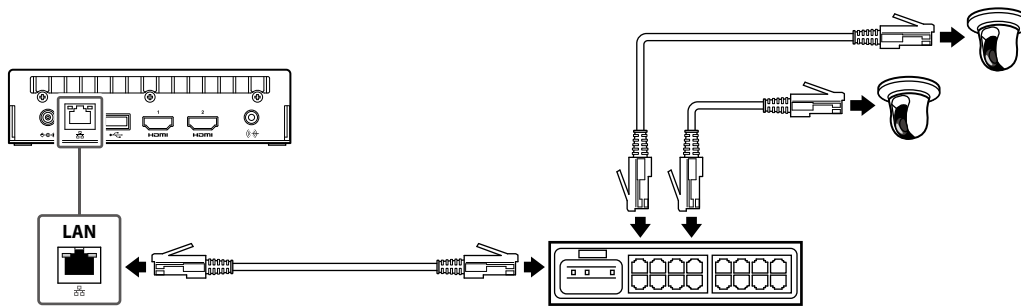

2. Connect this product and a video display monitor with an HDMI cable.

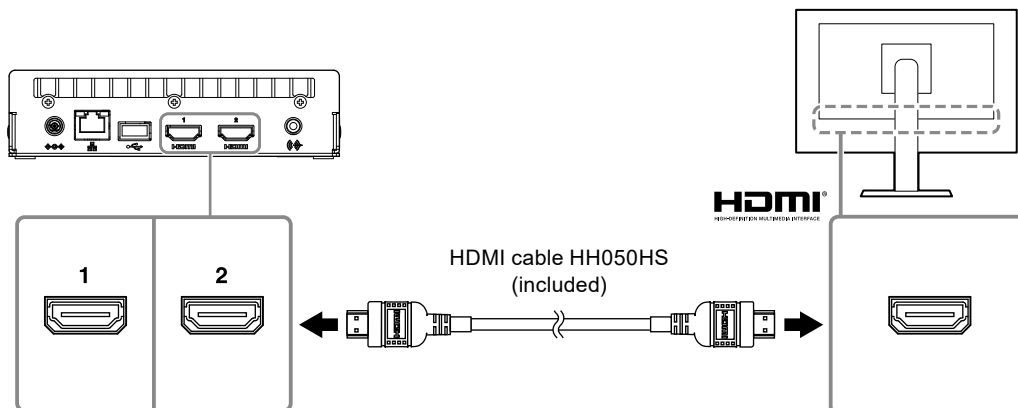

3. Connect the USB mouse to the USB downstream port.

Note

- Connecting to a device with USB hub function enables operation with multiple USB devices.

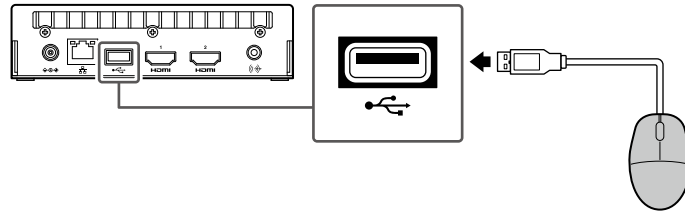

2-4. Turn on the Power and Display the Live Image Screen

1. Press the power button (⏻) on the front of the product.

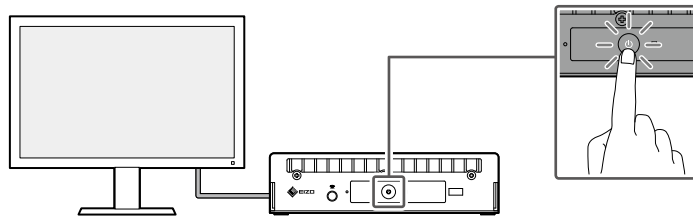

The power indicator lights up blue and the live image screen is displayed.

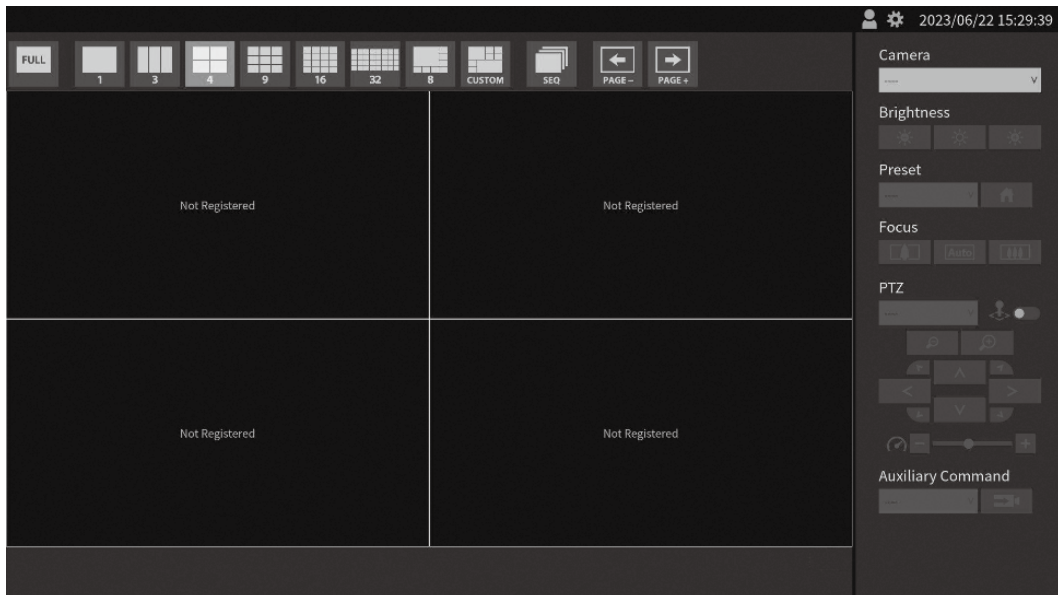

Live Image Screen

Note

- To turn off the power, press the power button (⏻) on the front of the product.
- You can also turn the power on/off with the POWER button on the remote control.

2-5. Displaying the Setting Screen

The setting screen can be operated using the monitor console (screen displayed on the monitor) or the web console (screen displayed on the browser).

To display the setting screen, it is necessary to log in as a user with a user level of "ADMIN".

Note

- The default settings of the user account are as follows.
Username: "admin"
Password: "admin"
User level: "ADMIN"
-

• When Using the Monitor Console

Use a mouse to perform operations.

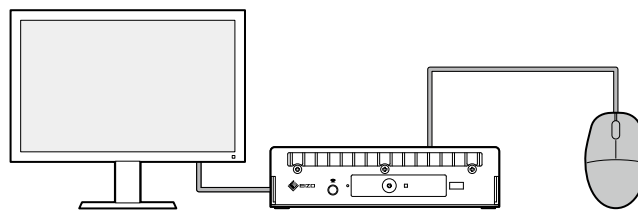

Attention

- Settings cannot be performed with the remote control.

Note

- Clicking an item that requires characters to be input will display a software keyboard.



1. On the live image screen, click the login icon (👤).

2. Enter a username and a password.

Username: "admin"

Password: "admin"

3. Click "Login".

The setting icon (⚙️) can then be selected.

4. Click the setting icon (⚙️).

● When Using the Web Console

Use a computer connected to the network to perform operations.

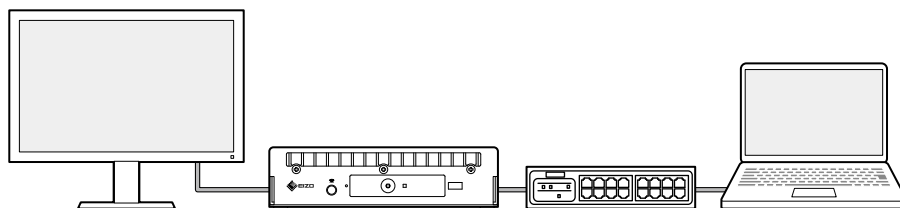

Note

- For information on computer network settings, refer to “4-7. Checking the IP Address of a Computer” (page 34).
-

1. Launch the browser.

2. Enter the following address to access the site.

Address: `http://<IP address of this product>/`

In the default settings, the IP address is `http://192.168.0.150/`.

If you cannot display the web console, refer to “4-4. Other Problems” (page 33).

3. Enter a username and a password.

Username: “admin”

Password: “admin”

4. Click “OK”.

The setting screen is displayed.

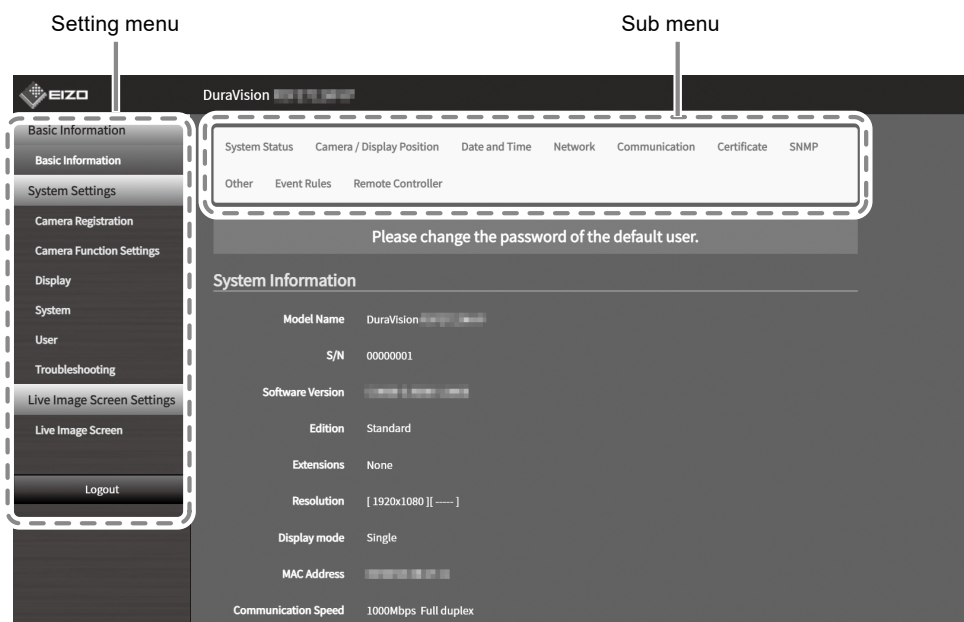

Settings screen (Web console)

When viewed on the monitor console, “Return” is displayed instead of “Logout”.

2-6. Setting the Date and Time

Setting the correct date and time in the system will prevent problems communicating with cameras.

1. Select “System” > “Date and Time”.

2. Set the current date and time.

Time Zone Settings

Item	Description	Range
Time Zone	Set the time zone.	Region/City

Clock Settings

Item	Description	Range
Procedure	Select the time setting procedure. Items are displayed when using the web console. When “Synchronize with PC” is selected for, the current date and time of the computer is set to this product.	Manual/Synchronize with PC
Date and Time	Set the current time.	2020/1/1 0:00 to 2050/12/31 23:59

3. Click “Apply”.

2-7. Setting the IP Address

1. Select “System” > “Network”.
2. Set the IP address.

• Network Settings

Item	Description	Range
IP Setting Method	Select the IP address setting method. Note <ul style="list-style-type: none">• If you have a DHCP server, select “DHCP” and the IP address will be set automatically. Since the IP address that is set cannot be checked on the web console, check it on the monitor console.	DHCP/Manual
IP Address	Set an IP address that does not overlap with another device. If your network environment does not include a gateway, you do not need to set the “Gateway”. Leave either as default setting or blank.	0.0.0.1 to 255.255.255.254
Subnet Mask		
Gateway		

3. Click “Apply”.

2-8. Configuring the Language

1. Select “System” > “Other”.
2. Select a language from the “Language” list box.
3. Click “Apply”.

2-9. Registering a Camera Using Auto Discovery

Cameras connected to the network can be automatically detected and registered.

Attention

The following cameras and video encoders must be registered manually (refer to “3-4. Registering a Camera Manually” (page 24)).

- Cameras that cannot be discovered automatically
 - Cameras on different subnets cannot be discovered automatically.
 - Some cameras can be set to deny auto discovery or allow auto discovery only for a certain period of time after the camera is turned on.
- Fisheye/panoramic cameras with multiple video streams
- Video encoder with multiple cameras connected

1. Select “Camera Registration”.

2. Click “Auto Discovery”.

3. Set the following items.

Item	Description
Protocol	Select the protocol for controlling the camera. “Panasonic/i-PRO”: Panasonic/i-PRO camera “AXIS”: Axis camera (VAPIX®) “ONVIF*1”: ONVIF Profile S compatible camera
Username	Enter the username of the camera. A user with administrator privileges is required.
Password	Enter the password of the camera.

*1 If “Protocol” is set to “ONVIF”, “Media Type” will be “Media1”.

4. Click “OK”.

A list of discovered cameras is displayed.

Auto discovery of cameras depends on the camera and network. Cameras that do not appear in the list must be registered manually.

5. Check the camera to register, and select “Add”.

6. Click “Apply”.

The camera image is displayed on the live screen.

If a communication error is displayed, refer to “4-2. Camera Registration Problems” (page 29).

If the video is not displayed correctly, refer to “4-3. Video Problems” (page 30).

2-10.Preparing the Remote Control

1. Press the knob to unlock and remove the cover.

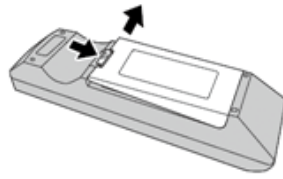

2. Insert AA batteries and put the cover back on.

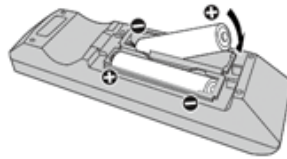

Chapter 3 Other Settings

3-1. Updating software

Use the web console to perform operations.

For stable operation of the system, it is recommended to use the latest software. It is not possible to revert to an older version.

- 1. Select “System” > “Maintenance”.**

The current software version is displayed.

- 2. Click “Browse” under “Software Update”.**

- 3. Select the software file (extension: duraup4).**

- 4. Click “Start”.**

- 5. Click “OK” in the confirmation dialog box.**

The process starts.

During processing, the power indicator flashes red. Do not turn off the power. It takes approximately five minutes to update the software.

3-2. Registering a license

Use the web console to perform operations.

- 1. Select “System” > “Maintenance”.**

- 2. Click “Activate” under “License Activation”.**

- 3. Click “Browse” and select the license file (extension: duralic).**

When selecting multiple license files, click the “Add (+)” button.

- 4. Click “Start”.**

The process starts.

Close the browser and wait 2 minutes before accessing again.

Attention

- Select “Deactivate” to deactivate all additionally registered licenses.
-

3-3. Save and Load Settings Data to Other Products

Use the web console to perform operations.

You can save settings data for products that have completed setup and load them to other products on the network. This eliminates the need to set up one unit at a time.

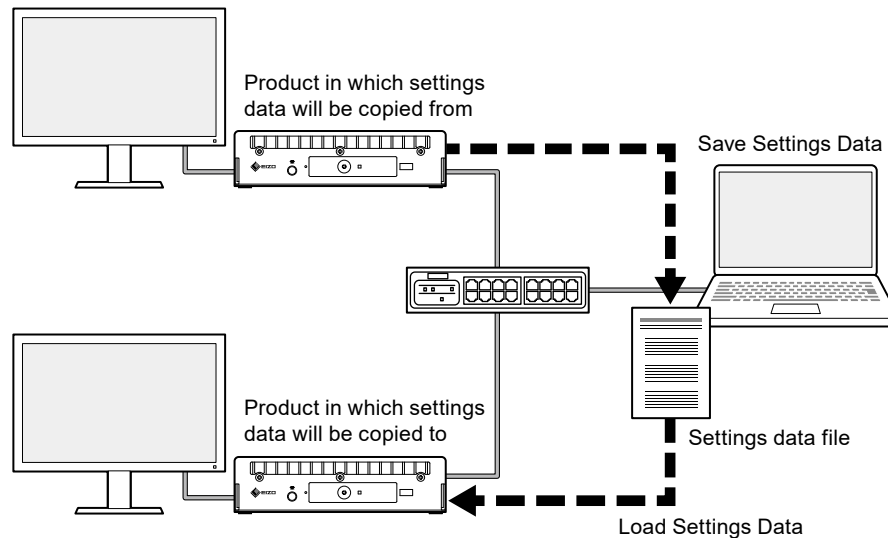

Attention

- Set unique IP addresses for each product in advance. If the IP address is duplicated, the web console cannot be displayed.

Note

- If an enterprise license is registered, the live image screen can be displayed on the browser. It is convenient because you can remotely check whether the camera image displays on the product in which the settings data is to be copied to. For details on the livestream view feature, refer to the User's Manual.

1. Display the web console of the product in which the settings data is to be copied from.

Address: <http://<IP address of the product in which settings data will be copied from>>

2. Select “System” > “Maintenance”.

3. Click “Save Settings Data”.

4. Set a password for the file.

5. Click “Execute”.

6. Specify where to save the file.

The settings data file is saved.

7. Display the web console of the product in which the settings data is to be copied to.

Address: <http://<IP address of the product in which settings data will be copied to>>

8. Select “System” > “Maintenance”.

9. Click “Load Settings Data”.

10. Select the settings data file and enter the password you have set.

Do not check “Network Settings”.

11. Click “Execute”.

The process is performed.

3-4. Registering a Camera Manually

The following cameras and video encoders must be registered manually.

- Cameras that cannot be discovered automatically
- Fisheye/panoramic cameras multiple streams of different images
 - Register multiple fisheye/panoramic cameras with the same IP address and specify which stream to display.
- Video encoder with multiple cameras connected
 - Register multiple video encoders with the same IP address and specify the streams to be displayed. For Panasonic/i-PRO video encoders that support multiple channels, specify the camera to be displayed in “Channel”.

Attention

- The camera must be connected to the network even when registering a camera manually.

1. Select “Camera Registration”.

2. Check the position number to register, and click “Manual Registration”.

3. Set each item in the manual registration dialog box.

The displayed items vary depending on the protocol. First select “Protocol”.

Item	Description	Range
Camera Name	Enter the camera name. To enter characters other than alphanumeric characters and symbols, use the web console. Enter “IP Address”, “Port”, “Username”, “Password” and click “Obtain Camera Name” to get the camera name from the camera.	Any character (up to 100 characters)
IP Address	Enter the IP address of the camera.	0.0.0.1 to 255.255.255.254
“Ping” button	Executes a connection test with the camera (refer to “4-5. Checking a Camera Connection with Ping” (page 33)).	-
Port	Enter the port number of the camera. Note <ul style="list-style-type: none">• Typical port numbers are “80” (“443” if SSL is enabled) when “Protocol” is “Panasonic/i-PRO”, “AXIS”, “ONVIF”, and “554” when “Protocol” is “DirectUri” and “URI” is an RTSP stream URI.• If “Protocol” is set to “EIZO Streaming Gateway,” enter the access port of the Streaming Gateway web server (default: 80).• If “Protocol” is set to “Qognify”, enter the server access port of the Qognify VMS (default: 62000).	1 to 65535

Item	Description	Range
SSL	Provides secure communication. Attention <ul style="list-style-type: none"> The camera must be set with a server certificate. The video is not encrypted. Video is encrypted when "Protocol" is "SRT" or when "Protocol" is "AXIS" and "Transmission Mode" is "SRTP over UDP" 	-
Certificate Validation	Select certificate validation during SSL communication. Attention <ul style="list-style-type: none"> If "Certificate Validation" is "On", the, it is necessary for the root certificate of the camera to be registered in "Root Certificate" under "Certificate". 	On / Off
Protocol	Select the protocol for controlling the camera. <ul style="list-style-type: none"> Panasonic/i-PRO Panasonic/i-PRO camera AXIS Axis camera (VAPIX) ONVIF ONVIF Profile S compatible camera DirectUri Select to connect to a RTSP stream URI (URI starting with rtsp://) or a RTP stream URI (URI starting with rtp://). SRT Select to connect to an SRT stream URI. EIZO Streaming Gateway Select this when connecting to DX0212-IP*³ with the streaming gateway function enabled. Qognify Select this when linking with a Qognify VMS. 	Panasonic/i-PRO / AXIS / ONVIF / DirectUri / SRT* ¹ / EIZO Streaming Gateway / Qognify* ²
Username	Enter the username of the camera. A user with administrator privileges is required.	Alphanumeric characters and symbols (up to 32 characters)
Password	Enter the password of the camera.	Alphanumeric characters and symbols (up to 32 characters)

*1 This can be selected when an enterprise license and an "SRT" extended functionality license are registered for this product.

*2 This can be selected when an enterprise license and a "Qognify" extended functionality license are registered for this product.

*3 The streaming gateway function settings must be completed in advance.

When "Panasonic/i-PRO" is selected

Unicast/Multicast cannot be set from this product. Change the transmission mode on the camera side.

Item	Description	Range
Comm. Method	Select the communication method for camera video images.	RTP over UDP
Stream	Select the stream to connect to.	1 / 2 / 3 / 4
Channel	Select a stream channel.	1 / 2 / 3 / 4
RS485PTZ Control	Set whether to operate the RS485 pan tilt platform from a camera that supports RS485 communication.	On / Off

When “AXIS” is selected

Item	Description	Range
Video Stream	Select the view area for the stream. Click “Obtain Stream” to get a list of view areas from the camera. Note • The view area is used to stream a portion of the entire image. For details, refer to the User’s Manual of the camera.	Depends on the camera
Stream Profile	Specify the stream to connect to by selecting a stream profile. Click “Obtain Profile” to get a list of profiles from the camera. Note • If no profile is registered on the camera, this product will automatically register the “EIZO_Profile” profile to the camera.	Depends on the camera
Transmission Mode	Select the transmission mode.	Unicast / Multicast
Comm. Method	Select the communication method for camera video images.	RTP over UDP / RTP over RTSP / SRTP over UDP*1

*1 This can be selected when an enterprise license is registered for this product. If you select “SRTP over UDP”, check “SSL”. In addition, enable the SRTP setting on the camera.

When “ONVIF” is selected

Item	Description	Range
Media Type	Select the media type. • Media1 (default setting) Select when connecting to H.264 or MJPEG streams. • Media2 Select to connect to H.265 and H.264 streams.	Media1 / Media2
Media Profile	Specify the stream to connect to by selecting a media profile. Click “Obtain Profile” to get a list of profiles from the camera.	Depends on the camera
Transmission Mode	Select the transmission mode.	Unicast / Multicast
Comm. Method	Select the communication method for camera video images.	RTP over UDP / RTP over RTSP

When “DirectUri” is selected

Item	Description	Range
URI	Enter the RTSP stream URI (URI starting with rtsp://, http://, or https://) or RTP stream URI (URI starting with rtp://).	Alphanumeric characters (up to 1023 characters)
Transmission Mode	Select the transmission mode.	Unicast / Multicast / Source-Specific Multicast
Comm. Method	Select the communication method for camera video images	RTP over UDP / RTP over RTSP / MPEG2-TS over UDP / RTSP over HTTP / RTSP over HTTPS

Note

- To receive an MPEG2-TS stream with RTP, select “RTP over UDP” or “RTP over RTSP” in “Comm. Method”.
- To receive an MPEG2-TS stream over UDP, check the following points.
 - Specify the port number (1024 to 65535) that receives the stream in “Port” and select “MPEG2-TS over UDP” in “Comm. Method”.
 - You should make stream transmission settings for this product from the transmitter in advance.
 - For non-multicast communication, leave the IP address blank.

When “SRT” is selected

This product operates in Caller mode. Set the camera to Listener mode.

Item	Description	Range
Latency	Set the latency	20 ms to 8000 ms
URI	Enter the SRT stream URI (URI starting with rtp://).	Alphanumeric characters (up to 1023 characters)
Passphrase	Sets the passphrase.	Alphanumeric characters and symbols (up to 79 characters)

When “EIZO Streaming Gateway” is selected

Item	Description	Range
Stream List	Specify the stream to connect to. Click the "Obtain Stream List" button to get a list of streams from the transmitter. Attention • If “Streaming Gateway” > “Streaming settings” > “Protocol” of the source is set to “RTP”, you cannot select that stream.	-
RTSP - Username	The RTSP username is automatically set. It can also be changed.	Alphanumeric characters and symbols (up to 79 characters)
RTSP - Password	The RTSP password is automatically set. It can also be changed.	Alphanumeric characters and symbols (up to 79 characters)
RTSP - Connection method	Select the communication method for camera video images.	RTP over RTSP
SRT - Latency ^{*1}	Set the latency.	20 ms to 8000 ms
SRT - Passphrase ^{*1}	The passphrase is automatically set. It can also be changed.	Alphanumeric characters and symbols (up to 79 characters)

*1 This can be selected when an enterprise license and an "SRT" extended functionality license are registered for this product.

When “Qognify” is selected

Item	Description	Range
Camera List	Click the "Obtain Camera List" button to display the acquired information.	-
Comm. Method	Select the communication method for camera video images.	RTP over RTSP

4. Click “OK”.

5. Click “Apply”.

The camera image is displayed on the live screen image.

If a communication error is displayed, refer to “4-2. Camera Registration Problems” (page 29).

If the video is not displayed correctly, refer to “4-3. Video Problems” (page 30).

Chapter 4 Troubleshooting

4-1. Power Problems

Problem	Possible cause and remedy
1. The live image screen is not displayed	<ul style="list-style-type: none">• The power indicator is not turned on<ul style="list-style-type: none">- Is the power correctly connected? Connect the AC adapter or network hub that supports PoE+.- Are the power cords of the AC adapter and network hub properly connected?• The power indicator is red<ul style="list-style-type: none">- Press the power button (⏻) on the front of the product.- Connected to a PoE-compatible network hub but power is insufficient. Connect to a network that supports PoE+ or to an AC adapter (sold separately).• The power indicator is blue<ul style="list-style-type: none">- Check whether the product is properly connected to the monitor with an HDMI cable. Connect to HDMI 1 instead of HDMI 2.- Pull out the HDMI cable and connect it again.- Check whether the input signal of the monitor is set to HDMI. Check if the monitor settings are correct. For details, refer to the User's Manual of the monitor.
2. After a power outage, the camera image is no longer displayed	<ul style="list-style-type: none">• If the error code "E**-**" is displayed, refer to "4-3. Video Problems" (page 30).• Request the camera to stream again.<ul style="list-style-type: none">- For the monitor console, click the setting icon (⚙️) with the mouse to display the settings screen, then select "Back" to return to the live image screen.- For the web console, select "Live Image Screen" > "Other" and click "Execute" under "Stream Refresh".• Depending on the camera, the settings may be reset when the power is turned off and on again. Check if the camera settings are correct (refer to "2-2. Setting Cameras" (page 11)).
3. Restarts all of a sudden	<ul style="list-style-type: none">• When the temperature inside the product rises high, this product may restart repeatedly. Check the temperature around this product. The internal temperature may rise high when the product is used in a narrow or poorly ventilated place or when the product is used with an object placed on top of it.

4-2. Camera Registration Problems

Problem	Possible cause and remedy
1. Communication error appears when clicking “Apply” in auto discovery	<ul style="list-style-type: none">• Make sure a password is set on the camera (refer to “2-2. Setting Cameras” (page 11)).• Make sure the user entered has administrative privileges.• If different user names and passwords are set for each camera, check the position number where the error is displayed, click “Manual Registration” and re-enter the username and password.
2. Communication error appears when clicking “Apply” in manual registration	<ul style="list-style-type: none">• Make sure a password is set on the camera (refer to “2-2. Setting Cameras” (page 11)).• Make sure the user entered has administrative privileges.• Make sure the IP address, HTTP port (typically 80), username and password of the camera are correct.• Make sure you can connect to the camera (refer to “4-5. Checking a Camera Connection with Ping” (page 33)).• Cameras not verified by EIZO may not be compatible with this product. Consider registering cameras with the “DirectUri” protocol. For the RTSP stream URI (URI starting with rtsp://) to be entered as the URI, refer to the User’s Manual of the camera or contact the camera manufacturer. When connected via the “DirectUri” protocol, video can be displayed, but PTZ control and setting changes cannot be performed on the camera.

4-3. Video Problems

Problem	Possible cause and remedy
<p>1. Error message “E**-**” is displayed</p> <p>If the problem is not resolved, refer to “3. Correct image is not displayed” (page 32)</p>	<ul style="list-style-type: none"> • E01-** <ul style="list-style-type: none"> - Check if the camera streaming settings are correct (refer to “2-2. Setting Cameras” (page 11)). - The camera may not be operating properly due to high load. Disconnect other network devices accessing the camera or reduce the resolution or bit rate of the camera. - If cameras are connected to different subnets, make sure that TCP/UDP communication is allowed on the router connecting the subnets. • E02-** <ul style="list-style-type: none"> E02-02 <ul style="list-style-type: none"> - Authentication has failed. Make sure the username and password of the camera are correct. E02-03 <ul style="list-style-type: none"> - Streaming has stopped. If the error is caused by the camera being turned off or disconnection of the camera, the error changes to E02-04. - If cameras are connected to different subnets, make sure that TCP/UDP communication is allowed on the router connecting the subnets. E02-04 <ul style="list-style-type: none"> - Check if the power of the camera is on. - Make sure you can connect to the camera (refer to “4-5. Checking a Camera Connection with Ping” (page 33)). - Make sure there are no duplicate IP addresses for the product or camera (refer to “4-6. Checking for Duplicate IP Addresses” (page 34)). <p>If the IP addresses of the products are duplicated, the camera image will be displayed on only one monitor.</p> <div data-bbox="687 1218 1398 1496" data-label="Diagram"> <p style="text-align: center;">Products with duplicate IP addresses</p> </div> E02-07 <ul style="list-style-type: none"> - If “Certificate Validation” is enabled, make sure that the certificate expiration date and other information are correct.

Problem	Possible cause and remedy
	<ul style="list-style-type: none"> • E03-** <ul style="list-style-type: none"> - Network bandwidth may be overwhelmed or the display capability of this product may have been exceeded. Reduce the resolution and/or bit rate of the camera (refer to “2-2. Setting Cameras” (page 11)). • E04-** <ul style="list-style-type: none"> - A resolution which is incompatible with this product may be set. Try changing the resolution of the camera (refer to “2-2. Setting Cameras” (page 11)). • E05-** <ul style="list-style-type: none"> - The stream format from the camera may be different from that of this product. Check the settings of the camera and this product and then restart this product. • E06-** <ul style="list-style-type: none"> - The multicast setting value may not be set correctly. Check the settings of the camera. • E07-** <ul style="list-style-type: none"> - The network may not be connected, such as the network cable is not connected to this product. Check the network connection. • E08-** <ul style="list-style-type: none"> - There is no available license to use the camera protocol. Check the license. • E09-** <ul style="list-style-type: none"> - The size of the data you want to play back may exceed the download limit for this product. Try changing the recording time and settings of the camera. - The data you want to play back may be in a format that this product does not support. Check the settings of the camera.
<p>2. Moving object slows down or speeds up</p> <p>If the problem is not resolved, refer to “3. Correct image is not displayed” (page 32)</p>	<ul style="list-style-type: none"> • The stream may contain B frames. Select “Live Image Screen” > “Other” and turn “B frame decode buffer” to “On”. If the problem does not resolve, turn it back “Off”. If B frames are the cause, disabling B frames on the camera can also resolve the problem. • Frames may not be output according to the timestamp from the camera. Select “Live Image Screen” > “Other” and turn “Sync timestamp” to “On”. If the problem does not resolve, turn it back “Off”.

Problem	Possible cause and remedy
<p>3. Correct image is not displayed</p> <ul style="list-style-type: none"> • Images are distorted • Displayed images are not smooth • Black images are displayed • Images are displayed or distorted at different times 	<ul style="list-style-type: none"> • Select “Live Image Screen” > “Other” and turn “Network traffic condition” to “On”. A circle indicating the communication status is displayed in the upper right corner of the image. If the circle is green, communication is normal. <div data-bbox="940 347 1147 472" data-label="Image"> </div> <p>If the circle is yellow or red, packets are not received successfully. There is a problem with the camera or network path.</p> <ul style="list-style-type: none"> - The camera may not be operating properly due to high load. Disconnect other network devices accessing the camera or reduce the resolution or bit rate of the camera. - Make sure there are no problems with the router, hubs, or network cables in the network path. <p>If the circle is gray, the stream exceeds the indicated performance of this product.</p> <ul style="list-style-type: none"> - Reduce the resolution and/or bit rate of the camera. <ul style="list-style-type: none"> • Make sure there are no duplicate IP addresses for the product or camera (refer to “4-6. Checking for Duplicate IP Addresses” (page 34)). • Make sure the camera user entered has administrative privileges. • Check if the camera streaming settings are correct (refer to “2-2. Setting Cameras” (page 11)). • If the protocol is “AXIS” or “ONVIF” and the transmission mode is “Unicast”, select “RTP over RTSP” as the connection method. Since TCP is used for streaming, the problem may resolve with packet control. • Check whether the used hubs and network cables are appropriate for handling the amount of information transferred. If the transmission mode is unicast, the amount of information transferred is (camera bit rate) x (number of connections). • Select “Troubleshooting” > “Network Connection Status”, and check the current communication bandwidth (sending, receiving).

4-4. Other Problems

Problem	Possible cause and remedy
1. Cannot log in	<ul style="list-style-type: none"> Re-enter the username and password. Reset the account information using the Reset button and log in as the default setting account (refer to "1-2. Controls and Functions" (page 7)).
2. Cannot display the setting screen	<ul style="list-style-type: none"> It is necessary to log in as a user with a user level of "ADMIN". A USB mouse is required to perform settings. Settings cannot be performed with the remote control.
3. The set date and time are not displayed correctly	<ul style="list-style-type: none"> If the system is not connected to the power supply for one week or longer, the date and time will not be displayed correctly. In such a case, set the date and time again (refer to "2-6. Setting the Date and Time" (page 18)).
4. Unable to view web console in browser	<ul style="list-style-type: none"> Make sure there are no duplicate IP addresses for the product (refer to "4-6. Checking for Duplicate IP Addresses" (page 34)). Check if the IP address of the computer is correct (Refer to "4-7. Checking the IP Address of a Computer" (page 34)).
5. License registration fails	<ul style="list-style-type: none"> Make sure the system is set to the correct date and time (refer to "2-6. Setting the Date and Time" (page 18)). Please send the error code, model name, serial number, product software version, and failed license file to your license reseller.
6. The mouse / keyboard does not work	<ul style="list-style-type: none"> Connect the USB cable correctly. Pull out the USB cable and connect it again. Make sure that the USB lock function is not enabled (refer to "User's Manual" for details).
7. The camera display position cannot be changed	<ul style="list-style-type: none"> "CAMERA CONTROL" or "ADMIN" users can operate the camera (refer to "User's Manual" for details). Display position of the camera cannot be changed during sequential display (refer to "User's Manual" for details).

4-5. Checking a Camera Connection with Ping

To execute a Ping, perform one of the following.

- Click "Ping" in the Manual Registration dialog box.
- Select "Troubleshooting" > "Connection Confirmation", then select the camera and click "Run".

If the camera cannot be connected, "Destination Host Unreachable" will be displayed. Make sure the camera is turned on and there are no problems with the router, hubs, or network cables in the network path.

Example) Execution Result

- If the camera can be connected

```
PING 192.168.0.27 (192.168.0.27) 56(84) bytes of data.
64 bytes from 192.168.0.27: icmp_seq=1 ttl=64 time=0.741 ms
64 bytes from 192.168.0.27: icmp_seq=2 ttl=64 time=0.771 ms
64 bytes from 192.168.0.27: icmp_seq=3 ttl=64 time=0.797 ms
```

- If the camera cannot be connected

```
PING 192.168.0.27 (192.168.0.27) 56(84) bytes of data.
From 192.168.0.150 icmp_seq=1 Destination Host Unreachable
From 192.168.0.150 icmp_seq=2 Destination Host Unreachable
From 192.168.0.150 icmp_seq=3 Destination Host Unreachable
```

4-6. Checking for Duplicate IP Addresses

Select “Troubleshooting” > “Network Connection Status”, and click “Current Status”. If the IP address of this product is duplicated with other devices, “Unicast reply from” will be displayed for the number of duplicated units. Set unique IP addresses.

Example) Execution Result

- If there are no duplicate IP addresses

```
ARPING 192.168.0.150 from 0.0.0.0 eth0
Sent 2 probes (2 broadcast(s))
Received 0 response(s)
```

- If there are duplicate IP addresses

```
ARPING 192.168.0.150 from 0.0.0.0 eth0
Unicast reply from 192.168.0.150 [00:00:00:00:00:00]*1
Sent 2 probes (2 broadcast(s))
Received 1
```

*1 The MAC address of duplicate device is displayed.

4-7. Checking the IP Address of a Computer

For Windows computers, you can check and change the LAN port network settings by following the steps below.

- 1. Press Windows + R key.**
- 2. Enter ncpa.cpl in the “Run” window and click “OK”.**
- 3. Select “Ethernet” from the list and double-click.**
If there are multiple LAN ports, “Ethernet 2” and “Ethernet 3” are displayed.
- 4. Select “Internet Protocol Version 4 (TCP/IPv4)” and click “Properties”.**
- 5. Change the network settings and click “OK”.**

For setting details, contact the computer manufacturer.

Appendix

Warning for Radio interference

For U.S.A., Canada Only

FCC Supplier's Declaration of Conformity

We, the Responsible Party

EIZO Inc.

5710 Warland Drive, Cypress, CA 90630

Phone: (562) 431-5011

declare that the product

Trade name: EIZO

Model: DuraVision DX0212-IP

is in conformity with Part 15 of the FCC Rules. Operation of this product is subject to the following two conditions: (1) this device may not cause harmful interference, and (2) this device must accept any interference received, including interference that may cause undesired operation.

WARNING!

This equipment has been tested and found to comply with the limits for a Class A digital device, pursuant to Part 15 of the FCC Rules. These limits are designed to provide reasonable protection against harmful interference when the equipment is operated in a commercial environment. This equipment generates, uses, and can radiate radio frequency energy and if not installed and used in accordance with the instruction manual, may cause harmful interference to radio communications. Operation of this equipment in a residential area is likely to cause harmful interference in which case the user will be required to correct the interference at his own expense.

Changes or modifications not expressly approved by the party responsible for compliance could void the user's authority to operate the equipment.

Note

Use the attached specified cable below or EIZO signal cable with this monitor so as to keep interference within the limits of a Class A digital device.

- AC Adapter
- Shielded Signal Cable (enclosed)

Canadian Notice

This Class A information technology equipment complies with Canadian ICES-003.

Cet équipement informatique de classe A est conforme à la norme NMB-003 du Canada.

For Europe, Australia, New Zealand, etc Only

Warning

Operation of this equipment in a residential environment could cause radio interference.

Warnung

Der Betrieb dieses Geräts in einer Wohnumgebung könnte Funkstörungen verursachen.

Avertissement

L'utilisation de cet équipement dans une zone résidentielle pourrait provoquer des interférences radio.

LIMITED WARRANTY

EIZO Corporation (hereinafter referred to as “**EIZO**”) and distributors authorized by EIZO (hereinafter referred to as the “**Distributors**”) warrant, subject to and in accordance with the terms of this limited warranty (hereinafter referred to as the “**Warranty**”), to the original purchaser (hereinafter referred to as the “**Original Purchaser**”) who purchased the product specified in this document (hereinafter referred to as the “**Product**”) from EIZO or Distributors, that EIZO and Distributors shall, at their sole discretion, either repair or replace the Product at no charge if the Original Purchaser becomes aware within the Warranty Period (defined below) that the Product malfunctions or is damaged in the course of normal use of the Product in accordance with the description in the instruction manual of the Product (hereinafter referred to as the “**User’s Manual**”).

The period of this Warranty is two (2) years from the date of purchase of the Product (hereinafter referred to as the “**Warranty Period**”). EIZO and Distributors shall bear no liability or obligation with regard to the Product in relation to the Original Purchaser or any third parties other than as provided under this Warranty.

EIZO and Distributors will cease to hold or store any parts (excluding design parts) of the Product upon expiration of seven (7) years after the production of the Product is discontinued. In repairing the Product, EIZO and Distributors will use renewal parts which comply with our QC standards. If the unit cannot be repaired due to its condition or the stockout of a relevant part, EIZO and Distributors may offer the replacement by a product with equivalent performance instead of repairing it.

The Warranty is valid only in the countries or territories where the Distributors are located. The Warranty does not restrict any legal rights of the Original Purchaser.

Notwithstanding any other provision of this Warranty, EIZO and Distributors shall have no obligation under this Warranty whatsoever in any of the cases as set forth below:

- (a) Any defect of the Product caused by freight damage, modification, alteration, abuse, misuse, accident, incorrect installation, disaster, adherent dust, faulty maintenance and/or improper repair by third party other than EIZO and Distributors;
- (b) Any incompatibility of the Product due to possible technical innovations and/or regulations;
- (c) Any deterioration of the sensor, including measurement value of the sensor;
- (d) Any defect of the Product caused by external equipments;
- (e) Any defect of the Product caused by the use under environmental conditions other than EIZO and Distributors’ estimation;
- (f) Any deterioration of the attachments of the Product (e.g. cables, User’s Manual, CD-ROM, etc.);
- (g) Any deterioration of the consumables, and/or accessories of the Product (e.g. batteries, remote controller, touch pen, etc.);
- (h) Any deformation, discoloration, and/or warp of the exterior of the Product;
- (i) Any defect of the Product caused by placement in a location where it may be affected by strong vibration or shocks;
- (j) Any deterioration or malfunction of the cooling fan caused by adherent dust.

To obtain service under the Warranty, the Original Purchaser must deliver the Product, freight prepaid, in its original package or other adequate package affording an equal degree of protection, assuming the risk of damage and/or loss in transit, to the local Distributor. The Original Purchaser must present proof of purchase of the Product and the date of such purchase when requesting services under the Warranty.

The Warranty Period for any replaced and/or repaired product under this Warranty shall expire at the end of the original Warranty Period.

EIZO OR DISTRIBUTORS ARE NOT RESPONSIBLE FOR ANY DAMAGE TO, OR LOSS OF, DATA OR OTHER INFORMATION STORED IN ANY MEDIA OR ANY PART OF ANY PRODUCT RETURNED TO EIZO OR DISTRIBUTORS FOR REPAIR.

EIZO AND DISTRIBUTORS MAKE NO FURTHER WARRANTIES, EXPRESSED OR IMPLIED, WITH RESPECT TO, INCLUDING, WITHOUT LIMITATION, THE PRODUCT AND ITS QUALITY, PERFORMANCE, MERCHANTABILITY OR FITNESS FOR ANY PARTICULAR USE. IN NO EVENT SHALL EIZO OR DISTRIBUTORS BE LIABLE FOR ANY INCIDENTAL, INDIRECT, SPECIAL, CONSEQUENTIAL OR OTHER DAMAGE WHATSOEVER (INCLUDING, WITHOUT LIMITATION, DAMAGES FOR LOSS OF PROFIT, BUSINESS INTERRUPTION, LOSS OF BUSINESS INFORMATION, OR ANY OTHER PECUNIARY LOSS) ARISING OUT OF THE USE OR INABILITY TO USE THE PRODUCT OR IN ANY CONNECTION WITH THE PRODUCT, WHETHER BASED ON CONTRACT, TORT, NEGLIGENCE, STRICT LIABILITY OR OTHERWISE, EVEN IF EIZO OR DISTRIBUTORS HAVE BEEN ADVISED OF THE POSSIBILITY OF SUCH DAMAGES. THIS EXCLUSION ALSO INCLUDES ANY LIABILITY WHICH MAY ARISE OUT OF THIRD PARTY CLAIMS AGAINST THE ORIGINAL PURCHASER. THE ESSENCE OF THIS PROVISION IS TO LIMIT THE POTENTIAL LIABILITY OF EIZO AND DISTRIBUTORS ARISING OUT OF THIS LIMITED WARRANTY AND/OR SALES.

