

# User's Manual

## **FORIS<sup>®</sup>** **FS2434**

**Color LCD Monitor**

### **Important**

Please read PRECAUTIONS, this User's Manual, and the Setup Guide (separate volume) carefully to familiarize yourself with safe and effective usage.

- 
- Please refer to the Setup Guide for basic information ranging from connection of the monitor to a PC or external device to using the monitor.
  - The latest User's Manual is available for download from our web site:  
<http://www.eizoglobal.com>
- 



## Location of Caution Statement

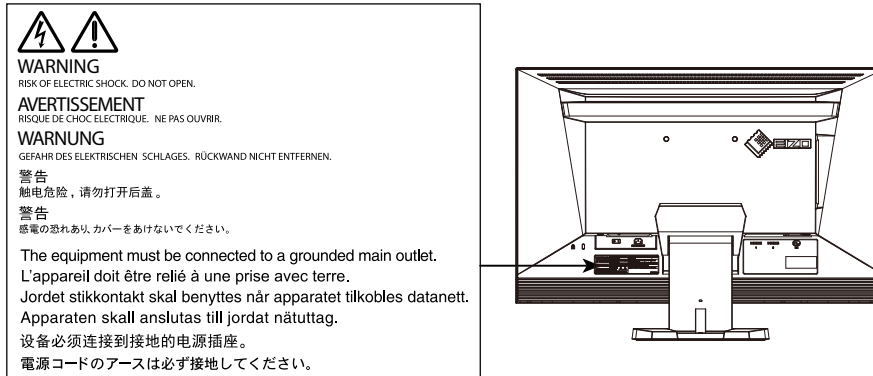

<For USA-California Only>

CR Coin Lithium Battery contains Perchlorate Material - special handling may apply.

See [www.dtsc.ca.gov/hazardouswaste/perchlorate](http://www.dtsc.ca.gov/hazardouswaste/perchlorate).

This product has been adjusted specifically for use in the region to which it was originally shipped. If operated outside this region, the product may not perform as stated in the specifications.

No part of this manual may be reproduced, stored in a retrieval system, or transmitted, in any form or by any means, electronic, mechanical, or otherwise, without the prior written permission of EIZO Corporation. EIZO Corporation is under no obligation to hold any submitted material or information confidential unless prior arrangements are made pursuant to EIZO Corporation's receipt of said information. Although every effort has been made to ensure that this manual provides up-to-date information, please note that EIZO monitor specifications are subject to change without notice.

# Notice for this monitor

---

This product is suited to purposes like displaying video games and viewing multimedia content.

---

This product has been adjusted specifically for use in the region to which it was originally shipped. If the product is used outside the region, it may not operate as specified in the specifications.

---

This product may not be covered by warranty for uses other than those described in this manual.

---

The specifications noted in this manual are only applicable when the following are used:

- Power cords provided with the product
  - Signal cables specified by us
- 

Only use optional products manufactured or specified by us with this product.

---

If you place this product on a lacquer-coated desk, the color may adhere to the bottom of the stand due to the composition of the rubber. Check the desk surface before use.

---

It takes about 30 minutes for the performance of electrical parts to stabilize. Please wait 30 minutes or more after the monitor power has been turned on, and then adjust the monitor.

---

Monitors should be set to a lower brightness to reduce changes in luminosity caused by long-term use and maintain a stable display.

---

When the screen image is changed after displaying the same image for extended periods of time, an afterimage may appear. Use the screen saver or power save function to avoid displaying the same image for extended periods of time. Depending on the image, an afterimage may appear even if it was displayed for a short period of time. To remove such a phenomenon, change the image or keep the power turned off for several hours.

---

If the monitor displays continuously over a long period of time, dark smudges or burn-in may appear. To maximize the life of the monitor, we recommend the monitor be turned off periodically.

---

Periodic cleaning is recommended to keep the monitor looking new and to prolong its operation lifetime (refer to [“Cleaning” \(page 4\)](#)).

---

The LCD panel is manufactured using high-precision technology. Although, missing pixels or lit pixels may appear on the LCD panel, this is not a malfunction. Percentage of effective dots: 99.9994% or higher.

---

The backlight of the LCD panel has a fixed lifetime. When the screen becomes dark or begins to flicker, please contact your EIZO representative.

---

Do not press on the panel or edge of the frame strongly, as this may result in display malfunctions, such as interference patterns, etc. If pressure is continually applied to the panel, it may deteriorate or damage your panel. (If the pressure marks remain on the panel, leave the monitor with a black or white screen. The symptom may disappear.)

---

Do not scratch or press on the panel with any sharp objects, as this may result in damage to the panel. Do not attempt to brush with tissues as this may scratch the panel.

---

---

When the monitor is cold and brought into a room or the room temperature goes up quickly, dew condensation may occur on the interior and exterior surfaces of the monitor. In that case, do not turn the monitor on. Instead wait until the dew condensation disappears, otherwise it may cause some damage to the monitor.

---

## Cleaning

---

### Attention

- Chemicals such as alcohol and antiseptic solution may cause gloss variation, tarnishing, and fading of the cabinet or panel, and also quality deterioration of the image.
  - Never use any thinner, benzene, wax, and abrasive cleaner, which may damage the cabinet or panel.
- 

### Note

- The optional ScreenCleaner is recommended for cleaning the cabinet and panel surface.
- 

If necessary, the stains on the cabinet and panel surface can be removed by moistening part of a soft cloth with water.

## To use the monitor comfortably

---

- An excessively dark or bright screen may affect your eyes. Adjust the brightness of the monitor according to the environmental conditions.
- Staring at the monitor for a long time tires your eyes. Take a 10-minute rest every hour.



# CONTENTS

|   |           |   |           |
|---|-----------|---|-----------|
| <b>Notice for this monitor</b> .....                                | <b>3</b>  | <b>3-4. Locking Operation Buttons</b> .....                                       | <b>29</b> |
| Cleaning .....  | 4         | <b>3-5. Showing and hiding the EIZO logo</b> .....                                | <b>29</b> |
| To use the monitor comfortably .....                                | 4         | <b>3-6. Setting Language</b> .....  | <b>29</b> |
| <b>CONTENTS</b> .....   | <b>5</b>  | <b>3-7. Changing the authentication method for HDMI signal input</b> .....        | <b>30</b> |
| <b>Chapter 1 Introduction</b> .....                                 | <b>7</b>  | <b>3-8. Resetting the Monitor to the Default Settings</b> .....                   | <b>30</b> |
| <b>1-1. Features</b> .....  | <b>7</b>  | ● To reset the color adjustments .....  | 30        |
| <b>1-2. Controls and Functions</b> .....                            | <b>8</b>  | ● To reset all adjustments to the default settings .....                          | 31        |
| ● Front .....   | 8         | <b>Chapter 4 Using Smart Function</b> .....                                       | <b>32</b> |
| ● Rear.....   | 9         | <b>4-1. Setting “Smart Detection”</b> .....                                       | <b>32</b> |
| ● Before Using Remote Control .....                                 | 11        | <b>4-2. Setting “Smart Resolution”</b> .....                                      | <b>33</b> |
| <b>1-3. Basic Operations and Functions</b> .....                    | <b>12</b> | <b>4-3. Setting “Smart Insight 2”</b> .....                                       | <b>34</b> |
| ● Basic operation of the Setting menu .....                         | 12        | <b>4-4. Checking the setting status</b> .....                                     | <b>34</b> |
| ● Functions .....   | 13        | <b>Chapter 5 Power Saving Functions</b> .....                                     | <b>35</b> |
| <b>Chapter 2 Adjusting Screens</b> .....                            | <b>14</b> | <b>5-1. Setting Power Saving</b> .....  | <b>35</b> |
| <b>2-1. Compatible Resolutions/Formats</b> .....                    | <b>14</b> | ● Monitor .....   | 35        |
| ● DVI-D Input and HDMI Input (PC signal) .....                      | 14        | ● To change the exiting method from the power saving mode .....                   | 36        |
| ● HDMI Input (video signal).....                                    | 14        | ● Audio Output .....  | 36        |
| <b>2-2. Setting the Resolution</b> .....                            | <b>15</b> | ● USB .....   | 37        |
| <b>2-3. Adjusting Color</b> .....                                   | <b>16</b> | <b>5-2. Setting Power Indicator</b> .....   | <b>37</b> |
| ● To select the display mode (Color Mode).....                      | 16        | <b>5-3. Enabling/Disabling Automatic Brightness Adjustment “Auto EcoView”</b> ... | <b>37</b> |
| ● To perform advanced adjustments .....                             | 17        | <b>5-4. Reducing Glare “EcoView Optimizer”</b> .....                              | <b>38</b> |
| ● Adjustable settings in each mode .....                            | 17        | <b>5-5. Checking the power saving level</b> .....                                 | <b>38</b> |
| ● To adjust brightness .....  | 18        | <b>5-6. Enabling/Disabling Auto Power-OFF “Off Timer”</b> .....                   | <b>39</b> |
| ● To Adjust Black Level “Black Level” .....                         | 18        | <b>Chapter 6 Connecting Cables</b> .....  | <b>40</b> |
| ● To adjust contrast .....  | 18        | <b>6-1. Connecting Multiple External Devices</b> .....                            | <b>40</b> |
| ● To adjust the color saturation .....                              | 19        | ● To switch among input signals .....   | 40        |
| ● To adjust hue .....   | 19        | <b>6-2. Connecting External Speaker</b> .....                                     | <b>41</b> |
| ● To adjust color temperature .....                                 | 20        | <b>Chapter 7 Troubleshooting</b> .....  | <b>42</b> |
| ● To adjust gamma .....   | 20        | <b>7-1. No picture</b> .....  | <b>42</b> |
| ● To adjust gain .....  | 21        | <b>7-2. Imaging problems</b> .....  | <b>43</b> |
| ● To reduce noise.....  | 21        | <b>7-3. Other problems</b> .....  | <b>44</b> |
| ● To set the enhancement ratio of ContrastEnhancer .....            | 22        | <b>Chapter 8 Reference</b> .....  | <b>46</b> |
| ● To set overdrive intensity .....                                  | 22        | <b>8-1. How to Attach the Optional Arm</b> .....                                  | <b>46</b> |
| <b>2-4. Setting the Color Space for the HDMI input signal</b> ..... | <b>23</b> | <b>8-2. Detaching/Attaching Stand Base</b> .....                                  | <b>48</b> |
| <b>2-5. Screen Size Changing</b> .....                              | <b>24</b> | <b>8-3. Attaching/Detaching Cable Holder</b> .....                                | <b>50</b> |
| ● DVI-D Input and HDMI Input (PC signal) .....                      | 24        | <b>8-4. Making Use of USB (Universal Serial Bus)</b> ...                          | <b>51</b> |
| ● HDMI Input (video signal).....                                    | 25        | ● Required System Environment .....   | 51        |
| ● To modify blurred characters/lines.....                           | 26        | ● Connection procedure (Setup of USB function).....                               | 51        |
| <b>Chapter 3 Setting Monitor</b> .....                              | <b>27</b> | <b>8-5. Displaying Monitor Information</b> .....                                  | <b>52</b> |
| <b>3-1. Switching sound source for HDMI signal input</b> .....      | <b>27</b> | <b>8-6. Specifications</b> .....  | <b>53</b> |
| <b>3-2. Adjusting Volume</b> .....                                  | <b>27</b> |   |           |
| ● To turn the volume up/down .....                                  | 27        |   |           |
| ● To mute the sound temporarily.....                                | 28        |   |           |
| <b>3-3. To adjust the sound level</b> .....                         | <b>28</b> |   |           |

|   |           |
|---|-----------|
| <b>Chapter 9 Glossary .....</b>   | <b>56</b> |
| <b>Appendix .....</b>   | <b>58</b> |
| Trademark .....   | 58        |
| License / Copyright.....  | 58        |
| FCC Declaration of Conformity .....                                       | 59        |
| Hinweise zur Auswahl des richtigen<br>Schwenkarms für Ihren Monitor ..... | 60        |
| Hinweis zur Ergonomie : .....   | 60        |
| LIMITED WARRANTY .....  | 61        |
| Recycling Information .....   | 70        |

# Chapter 1 Introduction

Thank you very much for choosing an EIZO color LCD monitor.

## 1-1. Features

- 23.8" wide format LCD
- Supports a resolution of 1920 × 1080
- Panel with a wide field of view adopted  
IPS panel with 178 ° horizontal and vertical viewing angles.
- HDMI connector × 2  
Applicable to the PC input signal using HDMI input, allowing three different digital signal inputs from a PC.
- The Color Mode function allows the user to select the display mode optimum to the displayed image.  
See "To select the display mode (Color Mode)" (page 16).
- EIZO's unique "Smart" technology
  - Smart Detection function  
This function allows the user to change the area on the screen to which the Smart Resolution or Smart Insight 2 function is applied (only animated images or whole screen).
  - Smart Resolution function  
This function adjusts the perceived resolution of the images so that the blurs are reduced and images are displayed vividly and clearly.  
In addition, you can correct the color of skin and text affected by the "Smart Resolution" settings.
  - Smart Insight 2 function  
This function analyzes the image and corrects the brightness for each pixel to make dark area of images visible. It also increases the color saturation.  
See "Chapter 4 Using Smart Function" (page 32).
- Input lag is less than 0.05 frames.  
Mouse movements and keyboard inputs are instantaneously reflected on the screen.
- Adopts EyeCare dimming  
Suppresses flicker when the LED backlight intensity is reduced.
- Equipped with a USB 3.0 hub function.  
Supports high-speed data transfers of up to 5 Gbps. Massive data can be transferred in a short time, e.g. when using a USB storage device.
- Thin bezel  
The thin bezel does not interfere with the movement of the line of sight when using multiple monitors.
- Stand with wide range of movement  
The monitor can be adjusted to a position where it provides you with a comfortable and less tiring work environment.  
(Tilt: 25 ° up / 0 ° down, Swivel: 344°, Adjustable height: 60 mm (2.36 inch))
- Remote control enables easy operation, setting and adjustment of the monitor.  
See "1-2. Controls and Functions" (page 8).
- Built-in stereo speakers and headphone jack  
See "1-2. Controls and Functions" (page 8).
- Line output connector  
A speaker with built-in amplifier can be connected to the monitor to output sound.  
See "6-2. Connecting External Speaker" (page 41).
- Displays HDCP (High-bandwidth Digital Protection) protected content.
- Supports the "G-Ignition" software which allows for screen adjustment via mouse or keyboard.  
Can be downloaded from our website (<http://www.eizoglobal.com>).

# 1-2. Controls and Functions

## ● Front

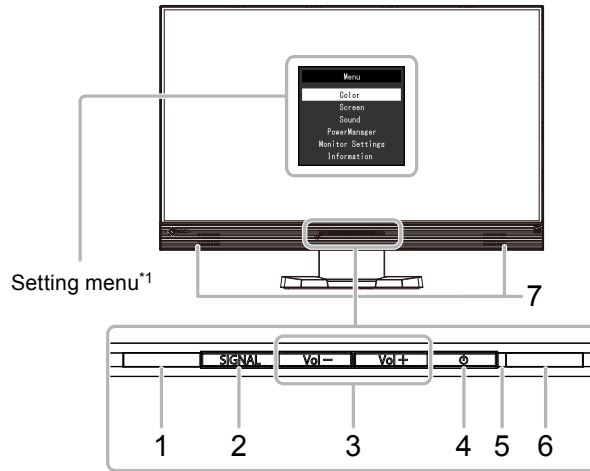

|                                   |   |
|-----------------------------------|---|
| 1. <b>Auto EcoView sensor</b>     | Detects ambient brightness (Auto EcoView function (page 37), EcoView Optimizer function (page 38)).                                 |
| 2. <b>SIGNAL button</b>           | Switches input signals for display (page 40).<br>PC (DVI) → HDMI1 → HDMI2   |
| 3. <b>Vol - / Vol + button</b>    | Displays the volume adjustment menu to volume up or down.   |
| 4. <b>Power button</b>            | Turns the power on or off.  |
| 5. <b>Power indicator</b>         | Indicates the monitor's operation status.<br>White: Operating<br>Orange: Power saving mode<br>Red: Power off<br>OFF: Main power off |
| 6. <b>Remote control detector</b> | Receives the signal from the remote control.  |
| 7. <b>Speaker</b>                 | Outputs audio source.   |

\*1 See "Basic operation of the Setting menu" (page 12) for how to use.

## ● Rear

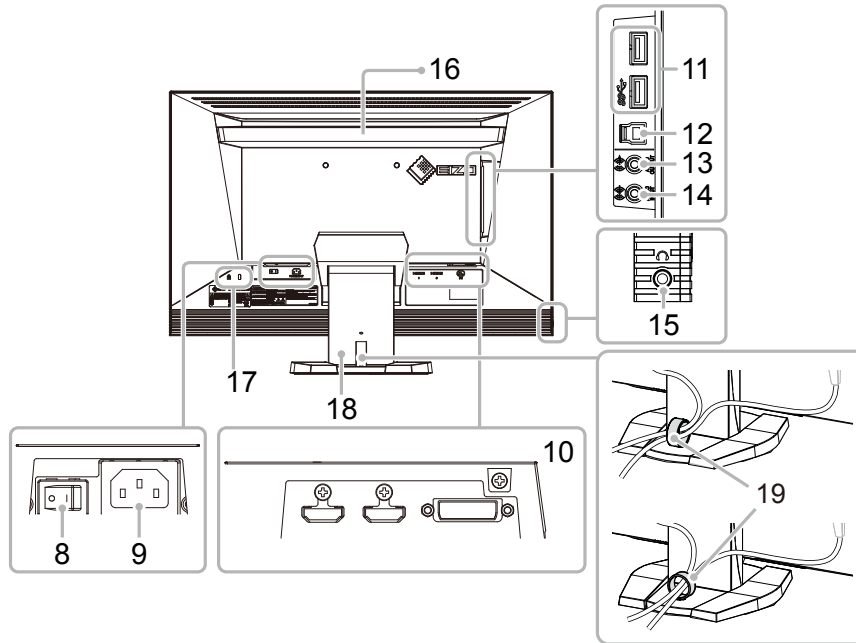



|                                   |   |
|-----------------------------------|---|
| <b>8. Main power switch</b>       | Turns the main power on or off. (○ : Off   : On)  |
| <b>9. Power connector</b>         | Connects the power cord.  |
| <b>10. Input signal connector</b> | (Left: HDMI connector (HDMI1) / Center: HDMI connector (HDMI2) / Right: DVI-D connector)<br>Connects external devices such as a PC.   |
| <b>11. USB downstream port</b>    | Connects a peripheral USB device.   |
| <b>12. USB upstream port</b>      | Connects the USB cable to use software that needs a USB connection, or to use the USB hub function (page 51).   |
| <b>13. Line output connector</b>  | (Stereo mini jack)<br>Connects a speaker with built-in amplifier (page 41).   |
| <b>14. Line input connector</b>   | (Stereo mini jack)<br>Connects external devices such as a PC.   |
| <b>15. Headphone jack</b>         | Connects the headphones.  |
| <b>16. Handle</b>                 | Handle used for transportation<br><b>Attention</b><br>• Firmly grasp and hold the monitor by the bottom while grabbing the handle, and carefully convey the monitor so as not to drop it. |
| <b>17. Security lock slot</b>     | Complies with Kensington's MicroSaver security system.  |
| <b>18. Stand*2</b>                | Adjusts the height and angle (tilt and swivel) of the monitor.  |
| <b>19. Cable holder</b>           | Covers the monitor cables.  |

\*2 An optional arm (or an optional stand) can be attached by removing the stand (see "8-1. How to Attach the Optional Arm" (page 46)).

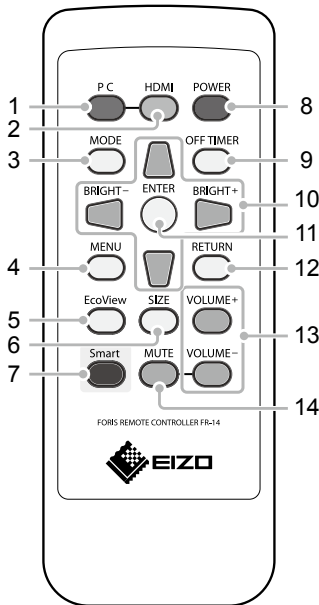
## Remote Control



|  |  |
|--|--|
| <b>1. PC</b>   | Switches to PC signal input.   |
| <b>2. HDMI</b>   | Switches to HDMI signal input.<br>Each time you press <b>HDMI</b> , the system toggles between HDMI1 and HDMI2.  |
| <b>3. MODE</b>   | Changes the color mode.  |
| <b>4. MENU</b>   | Displays/Exits the Setting menu.   |
| <b>5. EcoView</b>  | Displays/Exits "EcoView Menu".   |
| <b>6. SIZE</b>   | Changes the screen size.   |
| <b>7. Smart</b>  | Displays/Exits the "Smart Functions" menu.   |
| <b>8. POWER</b>  | Turns the power on or off.   |
| <b>9. OFF TIMER</b>  | Sets the time until the monitor power-off.   |
| <b>10.</b>  | <ul style="list-style-type: none"> <li>Provides the menu selection as well as the adjustment and setting of a function.</li> <li> /  : Displays the brightness adjustment menu (<a href="#">page 18</a>).</li> </ul> |
| <b>11. ENTER</b>   | Determines an item on the menu screen, and saves values adjusted.  |
| <b>12. RETURN</b>  | Returns to the previous menu in menu operation.  |
| <b>13. VOLUME +/-</b>  | Adjusts the volume.  |
| <b>14. MUTE</b>  | Mutes sound temporarily.   |

## ● Before Using Remote Control

### How to install battery

1. On the back of the remote control, slide the battery cover off in the direction of an arrow.
2. Insert a battery with the positive side up. (Battery model number: CR2025)
3. Reattach the cover.

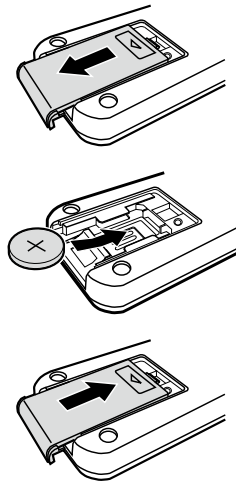

### Receivable Range of Remote Control

Use the remote control inside of the range as below.

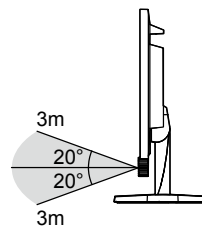
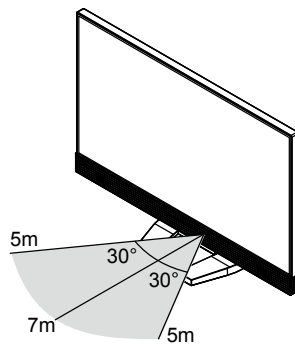

# 1-3. Basic Operations and Functions



## ● Basic operation of the Setting menu

### 1. Displaying the Setting menu



1. Press MENU on the remote control. The Setting menu appears.

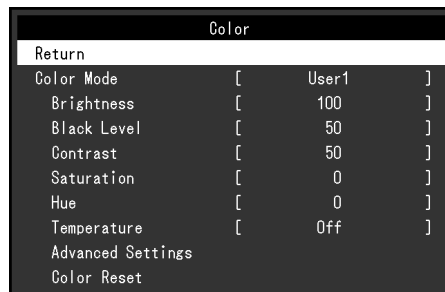

### 2. Adjusting/Setting

1. Choose a menu to adjust/set with , , and then press ENTER. The Sub menu appears.



2. Choose an item to adjust/set with , , and then press ENTER. The adjustment/setting menu appears.



3. Adjust/set the selected item with , , , , and then press ENTER.

### 3. Exiting

1. Press MENU.

---

#### Note

- To go back to the previous menu, press RETURN.
-



## ● Functions

The following table shows the Setting menu and setting items of each menu.

| Main menu           | Setting  | Reference   |                 |
|---------------------|--|---|-----------------|
| Color <sup>*1</sup> | Color Mode   | <a href="#">“2-3. Adjusting Color” (page 16)</a><br>(Regarding “Smart Functions”, see <a href="#">“Chapter 4 Using Smart Function” (page 32).</a> ) |                 |
|                     | Brightness   |   |                 |
|                     | Black Level  |   |                 |
|                     | Contrast   |   |                 |
|                     | Saturation   |   |                 |
|                     | Hue  |   |                 |
|                     | Temperature  |   |                 |
|                     | Advanced Settings  |   | Gamma           |
|                     |  |   | Gain            |
|                     |  |   | Noise Reduction |
| ContrastEnhancer    |  |   |                 |
| Smart Functions     |  |   |                 |
| Overdrive           |  |   |                 |
| Color Reset         | <a href="#">“3-8. Resetting the Monitor to the Default Settings” (page 30)</a> |   |                 |
| Screen              | Color Space <sup>*2</sup>  | <a href="#">“2-4. Setting the Color Space for the HDMI input signal” (page 23)</a>  |                 |
|                     | Smoothing  | <a href="#">“To modify blurred characters/lines” (page 26)</a>  |                 |
| Sound               | Source <sup>*2</sup>   | <a href="#">“3-1. Switching sound source for HDMI signal input” (page 27)</a>   |                 |
|                     | Sound Level  | <a href="#">“3-3. To adjust the sound level” (page 28)</a>  |                 |
|                     | Power Save   | <a href="#">“Audio Output” (page 36)</a>  |                 |
| PowerManager        | Power Save   | <a href="#">“5-1. Setting Power Saving” (page 35)</a>   |                 |
| Monitor Settings    | Key Lock   | <a href="#">“3-4. Locking Operation Buttons” (page 29)</a>  |                 |
|                     | Logo   | <a href="#">“3-5. Showing and hiding the EIZO logo” (page 29)</a>   |                 |
|                     | Power Indicator  | <a href="#">“5-2. Setting Power Indicator” (page 37)</a>  |                 |
|                     | Language   | <a href="#">“3-6. Setting Language” (page 29)</a>   |                 |
|                     | USB Power Save   | <a href="#">“USB” (page 37)</a>   |                 |
|                     | Reset  | <a href="#">“3-8. Resetting the Monitor to the Default Settings” (page 30)</a>  |                 |
| Information         |  | <a href="#">“8-5. Displaying Monitor Information” (page 52)</a>   |                 |

\*1 The adjustment/settings available on the “Color” menu depend on the selected Color mode (see [“Adjustable settings in each mode” \(page 17\)](#)).

\*2 This function is available with HDMI signal input.

# Chapter 2 Adjusting Screens

## 2-1. Compatible Resolutions/Formats

The monitor supports the following resolutions and signal format.

### ● DVI-D Input and HDMI Input (PC signal)

| Resolution                | Vertical Scan Frequency |
|---------------------------|-------------------------|
| 640 × 480                 | 60 Hz                   |
| 720 × 400                 | 70 Hz                   |
| 800 × 600                 | 60 Hz                   |
| 1024 × 768                | 60 Hz                   |
| 1280 × 720                | 60 Hz                   |
| 1280 × 960                | 60 Hz                   |
| 1280 × 1024               | 60 Hz                   |
| 1680 × 1050               | 60 Hz                   |
| 1920 × 1080 <sup>*1</sup> | 60 Hz                   |

\*1 Recommended resolution

### ● HDMI Input (video signal)

- Video signal

| Formats | Vertical Scan Frequency |       |
|---------|-------------------------|-------|
|         | 50 Hz                   | 60 Hz |
| VGA     | -                       | √     |
| 480p    | -                       | √     |
| 480i    | -                       | √     |
| 576p    | √                       | -     |
| 576i    | √                       | -     |
| 720p    | √                       | √     |
| 1080p   | √                       | √     |
| 1080i   | √                       | √     |

- Audio signal
  - 2ch linear PCM (32 kHz / 44.1 kHz / 48 kHz)

## 2-2. Setting the Resolution

When you connect the monitor to the PC and find that the resolution is improper, or when you want to change the resolution, follow the procedure below.

### Windows 10

1. Right-click the mouse anywhere on the desktop except for icons.
2. From the displayed menu, click “Display Settings”.
3. On the “Customize your display” dialog box, click “Advanced display settings”.
4. Select a monitor, then choose a resolution from the “Resolution” pull-down menu.
5. Click the “Apply” button.
6. When a confirmation dialog box is displayed, click “Keep changes”.

### Windows 8.1 / Windows 7

1. For Windows 8.1, click the “Desktop” tile on the Start Screen to display the desktop.
2. Right-click the mouse anywhere on the desktop except for icons.
3. From the displayed menu, click “Screen resolution”.
4. On the “Screen Resolution” dialog box, select the monitor.
5. Click “Resolution” to select the desired resolution.
6. Click the [OK] button.
7. When a confirmation dialog box is displayed, click [Keep changes].

### Windows Vista

1. Right-click the mouse anywhere on the desktop except for icons.
2. From the displayed menu, click “Personalize”.
3. On the “Personalization” window, click “Display Settings”.
4. On the “Display Settings” dialog box, select the “Monitor” tab and select desired resolution in the “Resolution” field.
5. Click the [OK] button.
6. When a confirmation dialog box is displayed, click [Yes].

### OS X Mountain Lion (10.8) or later

1. Select “System Preferences” from the Apple menu.
2. When the “System Preferences” dialog box is displayed, click “Displays”.  
(If using OS X Mountain Lion (10.8), click “Displays” in “Hardware”.)
3. In the displayed dialog box, select the “Display” tab and select “Change” in the “Resolutions” field.
4. Select the resolution from the list of possible resolution settings.  
If the target resolution is not displayed in the list, press and hold the Option key on the keyboard and select “Change”.
5. Your selection will be reflected immediately. When you are satisfied with the selected resolution, close the window.

## Mac OS X 10.7

1. Select “System Preferences” from the Apple menu.
2. When the “System Preferences” dialog box is displayed, click “Displays” for “Hardware”.
3. On the displayed dialog box, select the “Display” tab and select desired resolution in the “Resolutions” field.
4. Your selection will be reflected immediately. When you are satisfied with the selected resolution, close the window.

## 2-3. Adjusting Color

### ● To select the display mode (Color Mode)

This function allows easy selection of a desired mode according to monitor application.

#### Display Modes

| Mode               | Purpose   |
|--------------------|---|
| User1              | Select one of these user modes to define a desired set of parameter settings.                           |
| User2              |   |
| Game (Dark scene)  | Suitable for displaying games with dark images.   |
| Game (Light scene) | Suitable for displaying games with bright images.   |
| Cinema             | Produces theater screen-like images. Suitable for displaying images from media such as movies.          |
| Web / sRGB         | Suitable while displaying a web browser or for color matching with sRGB compatible peripherals.         |
| Paper              | Produces a printed paper effect. Suitable for displaying images from media such as books and documents. |



#### Procedure

1. Press MODE on the remote control.  
The mode name appears at the center of the screen.
2. The mode among the list is highlighted in turn each time MODE is pressed.  
You can switch the current mode with ◀ or ▶ while the mode menu is being displayed.

→User1←→User2←→Game (Dark scene)←→Game (Light scene)←→Cinema←→Web/sRGB←→Paper←

#### Note

- The Setting menu and the Mode menu cannot be displayed at the same time.
- When “G-Ignition” is used, the Color Mode automatically switches to the corresponding setting for the software being used.  
 (“G-Ignition” is a software that can be used to adjust the screen via mouse or keyboard. It is available for download on our website (<http://www.eizoglobal.com>).

## ● To perform advanced adjustments

The “Color” menu of the Setting menu allows you to set and save the independent color adjustment for each mode.

### Attention

- The monitor will take about 30 minutes before its internal electric components stabilize. Wait 30 minutes or more after turning the monitor power on before starting adjustment.
- The same image may be seen in different colors on multiple monitors due to their monitor-specific characteristics. Make fine color adjustment visually when matching colors on multiple monitors.

### Note

- You can adjust the color via mouse and keyboard by using “G-Ignition”. You can also save and load the adjusted settings as color data.

## ● Adjustable settings in each mode

The adjustable settings depend on the mode. (Non-adjustable or non-settable function cannot be selected.)

For instructions on how to adjust or set each function, refer to subsequent pages.

Regarding “Smart Functions”, see “[Chapter 4 Using Smart Function](#)” (page 32).

√: Adjustable -: Not adjustable

| Function          |                   | Color Mode       |   |        |          |       |   |
|-------------------|-------------------|------------------|---|--------|----------|-------|---|
|                   |                   | User1<br>User2   | Game<br>(Dark scene)<br>Game<br>(Light scene) | Cinema | Web/sRGB | Paper |   |
| Brightness        |                   | √                | √   | √      | √        | √     |   |
| Black Level       |                   | √                | √   | √      | -        | -     |   |
| Contrast          |                   | √                | √   | √      | -        | -     |   |
| Saturation        |                   | √                | √   | √      | -        | -     |   |
| Hue               |                   | √                | √   | √      | -        | -     |   |
| Temperature       |                   | √                | √   | √      | -        | √     |   |
| Advanced Settings | Gamma             | √                | √   | √      | -        | -     |   |
|                   | Gain              | √                | -   | -      | -        | -     |   |
|                   | Noise Reduction   | √                | √   | -      | -        | -     |   |
|                   | Contrast Enhancer | √                | √   | √      | -        | -     |   |
|                   | Smart Functions   | Smart Detection  | √   | √      | -        | -     | √ |
|                   |                   | Smart Resolution | √   | √      | √        | -     | √ |
| Smart Insight 2   |                   | √                | √   | √      | -        | -     |   |
| Overdrive         |                   | √                | √   | √      | -        | -     |   |
| Color Reset       |                   | √                | √   | √      | √        | √     |   |





## ● To adjust brightness

The screen brightness is adjusted by changing the brightness of the backlight (light source from the LCD back panel).

### **Adjustable range**

0 to 100

### **Procedure**

1. Press  or .
- The Brightness menu appears.
2. Use  or  for adjustment.
3. Press ENTER to exit.

---

#### **Note**

- If you feel that the image is too dark even if the brightness is set to 100, adjust the contrast.
  - Alternatively, you can use “Brightness” under “Color” in the Adjustment menu to adjust it.
- 



## ● To Adjust Black Level “Black Level”

You can adjust the level of brightness at the black part of an image by adjusting the black level. Please use a black test pattern or background for adjustment of the black level.

### **Adjustable range**

0 to 100

### **Procedure**

1. Choose “Color” in the Setting menu, and press ENTER .
2. Choose “Black Level” in the “Color” menu, and press ENTER .
- The “Black Level” menu appears.
3. Use  or  for adjustment.
4. Press ENTER to exit the adjustment.

---

#### **Note**

- After completing black level adjustment, readjust the contrast as appropriate.
- 



## ● To adjust contrast

The brightness of the screen is adjusted by varying the video signal level.

### **Adjustable range**

0 to 100

### **Procedure**

1. Choose “Color” in the Setting menu, and press ENTER.
2. Choose “Contrast” in the “Color” menu, and press ENTER.
- The “Contrast” menu appears.
3. Use  or  for adjustment.
4. Press ENTER to exit the adjustment.

---

#### **Note**

- In the contrast of 50, every color gradation is displayed (for PC input signal only).
  - When adjusting the monitor, it is recommended to perform the brightness adjustment which may not lose the gradation characteristics, prior to the contrast adjustment.
  - Perform the contrast adjustment in the following cases.
    - When you feel the image is too dark even if the brightness is set to 100 (Set the contrast to higher than 50.)
-

## ● To adjust the color saturation

This function allows you to adjust color saturation.

### **Adjustable range**

-50 to 50

### **Procedure**

1. Choose “Color” in the Setting menu, and press ENTER.
2. Choose “Saturation” in the “Color” menu, and press ENTER.  
The “Saturation” menu appears.
3. Use ◀ or ▶ for adjustment.
4. Press ENTER to exit the adjustment.

---

#### **Attention**

- Using this function may make some color gradations unavailable for display.

---

#### **Note**

- The minimum value (-50) changes the screen to monochrome.
- 

## ● To adjust hue

This function allows you to adjust hue.

### **Adjustable range**

-50 to 50

### **Procedure**

1. Choose “Color” in the Setting menu, and press ENTER.
2. Choose “Hue” in the “Color” menu, and press ENTER.  
The “Hue” menu appears.
3. Use ◀ or ▶ for adjustment.
4. Press ENTER to exit the adjustment.

---

#### **Attention**

- Using this function may make some color gradations unavailable for display.
-

## ● To adjust color temperature

Color temperature can be adjusted.

The color temperature is normally used to express the hue of “White” and/or “Black” by a numerical value. The value is expressed in degrees “K” (Kelvin).

The screen becomes reddish at a low color temperature, and bluish at a high color temperature, like the flame temperature. A gain preset value is set for each color temperature setting value.



### **Adjustable range**

Off, 4000K-10000K (specified by every 500K unit, including 9300K)

### **Procedure**

1. Choose “Color” in the Setting menu, and press ENTER.
2. Choose “Temperature” in the “Color” menu, and press ENTER.

The “Temperature” menu appears.

3. Use  or  for adjustment.
4. Press ENTER to exit the adjustment.

---

### **Note**

- The value shown in “K” is available only as reference.
  - “Gain” allows you to perform more advanced adjustment (see [“To adjust gain” \(page 21\)](#)).
  - If you set to “Off”, the image is displayed in the preset color of the monitor (Gain: 100 for each RGB).
  - When gain is changed, the color temperature is changed to “Off”.
- 

## ● To adjust gamma

Gamma can be adjusted. The brightness of the monitor varies depending on the input signal, however, the variation rate is not proportional to the input signal. To keep the balance between the input signal and the brightness of the monitor is called as “Gamma correction”.



### **Adjustable range**

1.8, 2.0, 2.2, 2.4, 2.6, 2.8, Power, RTS

### **Procedure**

1. Choose “Color” in the Setting menu, and press ENTER.
2. Choose “Advanced Settings” in the “Color” menu, and press ENTER.
3. Choose “Gamma” in the “Advanced Settings” menu, and press ENTER.

The “Gamma” menu appears.

4. Use  or  for adjustment.
5. Press ENTER to exit the adjustment.

---

### **Note**

- Choosing “Power” will help to sharpen halftone images by increasing their contrast.
  - “RTS” is suitable for display of RTS games and brightens low gradation areas of the screen.
-



## ● To adjust gain

The brightness of each color component red, green, and blue is called “Gain”. You can change the hue of “white” by adjusting gain.



### **Adjustable range**

0 to 100

### **Procedure**

1. Choose “Color” in the Setting menu, and press ENTER.
2. Choose “Advanced Settings” in the “Color” menu, and press ENTER.
3. Choose “Gain” in the “Advanced Settings” menu, and press ENTER.

The “Gain” menu appears.

4. Adjust gain with  or  for each of red, green, and blue.
5. Press ENTER to exit the adjustment.

---

### **Attention**

- Using this function may make some color gradations unavailable for display.

### **Note**

- The value of gain changes with that of color temperature.
  - When gain is changed, the color temperature is changed to “Off”.
- 



## ● To reduce noise

It is possible to reduce block noise (mosaic pattern) that is experienced when displaying compressed videos.

### **Procedure**

1. Choose “Color” in the Setting menu, and press ENTER.
2. Choose “Advanced Settings” in the “Color” menu, and press ENTER.
3. Choose “Noise Reduction” in the “Advanced Settings” menu, and press ENTER.

The “Noise Reduction” menu appears.

4. Select “Enable” or “Disable” with  or .
5. Press ENTER to exit the adjustment.

---

### **Attention**

- When “Noise Reduction” is set to “Enable,” details of the image can be lost.
-

## ● To set the enhancement ratio of ContrastEnhancer

This function allows you to automatically adjust the contrast according to the darkness or brightness of an image and change in scenes. You can set the level of the adjustment.



### **Adjustable range**

Enhanced, Standard, Off

### **Procedure**

1. Choose “Color” in the Setting menu, and press ENTER.
2. Choose “Advanced Settings” in the “Color” menu, and press ENTER.
3. Choose “ContrastEnhancer” in the “Advanced Settings” menu, and press ENTER.

The “ContrastEnhancer” menu appears.

4. Use  or  for adjustment.
5. Press ENTER to exit the adjustment.

---

### **Attention**

- Using this function may make some color gradations unavailable for display.
- 

## ● To set overdrive intensity

This function allows you to set overdrive intensity based on the use of the monitor. For example, you can reduce image lags by setting the adjustment level to “Enhanced” when displaying fast moving images such as game images.



### **Adjustable range**

Enhanced, Standard, Off

### **Procedure**

1. Choose “Color” in the Setting menu, and press ENTER.
2. Choose “Advanced Settings” in the “Color” menu, and press ENTER.
3. Choose “Overdrive” in the “Advanced Settings” menu, and press ENTER.

The “Overdrive” menu appears.

4. Use  or  for adjustment.
5. Press ENTER to exit the adjustment.

---

### **Attention**

- The overdrive function is disabled in the following cases:
    - For setting “Overscan [Off]” ([page 25](#))
  - When the vertical scanning frequency of the input signal exceeds 70 Hz.
  - When “Screen Size” is set to “Normal” (unless the display resolution is 1920 x 1080)
    - For setting “Overscan [On]” ([page 25](#))
  - When the display resolution is either 640 x 480, 720 x 480, or 720 x 576
-



## 2-4. Setting the Color Space for the HDMI input signal

You can specify the Color Space for the HDMI input signal. If the correct color is not displayed, change the setting to other than “Auto”.

√: Can be set -: Cannot be set

| Settings          | Function  | PC signal | Video signal |
|-------------------|---|-----------|--------------|
| Auto              | Identifies the color space of the input signal automatically (recommended). | -         | √            |
| YUV 4:2:2         | Converts the color space of the input signal to a YUV 4:2:2 format.         | √         | √            |
| YUV 4:4:4         | Converts the color space of the input signal to a YUV 4:4:4 format.         | √         | √            |
| RGB Full Range    | Converts the color space of the input signal to a RGB (0 to 255) format.    | √         | √            |
| RGB Limited Range | Converts the color space of the input signal to a RGB (16 to 235) format.   | √         | √            |

### Procedure

1. Choose “Screen” from the Setting menu, and press ENTER.
2. Choose “Color Space” from “Screen”, and press ENTER.  
The “Color Space” menu appears.
3. Use  or  for adjustment.
4. Press ENTER to exit.

### Attention

- The setting is required when a DVI device is connected to the monitor (at the HDMI connector port) using the DVI-HDMI conversion connector.
- Even if “Auto” is set, correct color might not be displayed. If this happens, change the setting to one where the screen is displayed correctly.

## 2-5. Screen Size Changing

### ● DVI-D Input and HDMI Input (PC signal)

The image with the resolution other than the recommended resolution is displayed in full screen automatically. You can change the screen size by using the “Screen Size” function.

| Setting     | Function  |
|-------------|---|
| Full Screen | Displays an image in full screen. Images are distorted in some cases because the vertical rate is not equal to the horizontal rate.                   |
| Enlarged    | Displays an image in full screen. In some cases, a blank horizontal or vertical border appears to equalize the vertical rate and the horizontal rate. |
| Normal      | Displays images with the specified resolution.  |

Example: Image size 1024 × 768

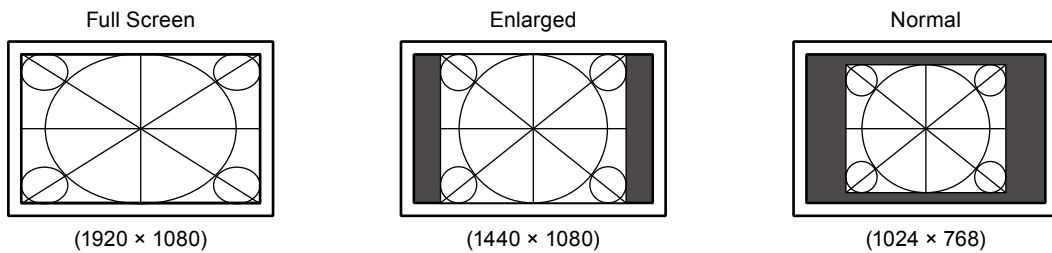

#### **Procedure**

1. Press SIZE on the remote control.  
Each time you press SIZE, the size changes.

---

#### **Note**

- When “Normal” is selected, the input lag is 2 frames or less.
-

## ● HDMI Input (video signal)

The screen size can be changed with the “Screen Size” function.

| Setting              | Function  | Screen Display |
|----------------------|---|----------------|
| Auto                 | The monitor automatically changes the screen size according to the aspect ratio <sup>*1</sup> and resolution information from the external device. This can be set only for HDMI (SD Signal) input. |                |
| Full Screen          | Displays an image in full screen. Images are distorted in some cases because the vertical rate is not equal to the horizontal rate.   |                |
| Enlarged             | Displays an image in full screen. In some cases, a blank horizontal or vertical border appears to equalize the vertical rate and the horizontal rate.   |                |
| Letterbox            | Displays Letterbox of 16 : 9 in full screen. Except for Letterbox, the upper and lower parts of the projected image are cut. This can be set only for HDMI (SD Signal) input.                       |                |
| Normal <sup>*2</sup> | The image is displayed without scaling the input signals.   |                |

\*1 The aspect ratio information of letterbox cannot be identified automatically.

\*2 When “Screen Size” is “Normal”, “Overscan” is fixed at “Off”.

### Procedure

1. Press SIZE on the remote control.  
Each time you press SIZE, the size changes.

#### Note

- When “Normal” is selected, the display input lag is 2 frames or less.

## To set the screen ratio

In order to hide distortion or noise at the image’s edge, the display area of the input image can be changed so that peripheral images are not displayed.

| Setting | Function  |
|---------|---|
| On      | Displays an input image in the screen by trimming the vertical and horizontal parts of the image. |
| Off     | Displays most of the input image.   |

### Procedure

1. Press SIZE on the remote control.  
The “Screen Size” menu appears.
2. Select “Overscan” with .
3. Use or for adjustment.
4. Press ENTER to exit.

#### Attention

- When “Screen Size” is “Normal”, “Overscan” is fixed at “Off”.

## ● To modify blurred characters/lines

When an image is displayed with a resolution other than recommended, the characters or lines of the displayed image may blur.

---



**Attention**

- Smoothing setting may not be required depending on the display resolution. (You cannot choose the smoothing icon.)
- 

### **Adjustable range**

1 to 5

### **Procedure**



1. Choose “Screen” in the Setting menu, and press ENTER.
2. Choose “Smoothing” in the “Screen” menu, and press ENTER.  
The “Smoothing” menu appears.
3. Use  or  for adjustment.
4. Press ENTER to exit the adjustment.

# Chapter 3 Setting Monitor

## 3-1. Switching sound source for HDMI signal input

This function allows you to switch sound source for HDMI signal input. You can select the HDMI or stereo mini jack.

### Procedure

1. Choose "Sound" in the Setting menu, and press ENTER.
2. Choose "Source" in the "Sound" menu, and press ENTER.  
The "Source" menu appears.
3. Select "HDMI" or "Stereo Mini Jack" with  or .
4. Press ENTER to exit the adjustment.

### Note

- This function is available with HDMI signal input. However, if a DVI-HDMI adapter cable is used, the sound source is automatically "Stereo Mini Jack" and cannot be changed.

## 3-2. Adjusting Volume

### ● To turn the volume up/down

This function allows you to adjust the volume.

### Adjustable range

0 to 30

### Procedure

1. Press VOLUME+ or VOLUME– on the remote control.

### Note

- Alternatively, you can use **Vol +** or **Vol –** on the monitor for adjustment (see "1-2. Controls and Functions" (page 8)).
- The volume setting is common for the HDMI input and stereo mini jack.

### Attention

- If a speaker with built-in amplifier is attached to the line output connector, adjust the volume on the external speaker. You cannot adjust the volume using the remote control or control buttons on the monitor.
- When you try to adjust the volume with all the conditions below, "This operation is not available on current status." is displayed.
  - The headphones are not connected.
  - A speaker with built-in amplifier is attached to the line output connector.

## ● To mute the sound temporarily

### **Procedure**

1. Press MUTE on the remote control.

Mute sound temporarily.

By pressing the button again or pressing VOLUME+, the sound comes back.

---

### **Note**

- The mute setting can also be released by pressing **Vol +** on the monitor.
- While the monitor is muted, press **VOLUME-** or **Vol -** on the monitor to decrease the volume setting.

---

### **Attention**

- If a speaker with built-in amplifier is attached to the line output connector, adjust the volume on the external speaker. You cannot adjust the volume using the remote control of the monitor.
  - When you try to mute the speaker with all the conditions below, “This operation is not available on current status” is displayed.
    - The headphones are not connected.
    - A speaker with built-in amplifier is attached to the line output connector.
- 

## 3-3. To adjust the sound level

---



The input sound level can be adjusted.

The volume difference may occur depending on the kinds of input signals, since the average sound level of the external device differs. You can reduce volume differences by adjusting the sound level. For example, if the volume difference of HDMI1 and HDMI2 input signals becomes large, you can reduce the volume difference between them by raising the “Sound Level” of the lower volume side.

### **Adjustable range**

-1 to 1

### **Procedure**

1. Choose “Sound” in the Setting menu, and press ENTER.
2. Choose “Sound Level” in the “Sound” menu, and press ENTER.  
The “Sound Level” menu appears.
3. Use  or  for adjustment.
4. Press ENTER to exit the adjustment.

---

### **Attention**



- This function is applicable to sound from the monitor speakers and headphones.
-



## 3-4. Locking Operation Buttons

This function allows you to lock the buttons on the monitor.

### **Procedure**

1. Choose “Monitor Settings” in the Setting menu, and press ENTER.
2. Choose “Key Lock” in the “Monitor Settings” menu, and press ENTER.  
The “Key Lock” menu appears.
3. Select “On” with  or .
4. Press ENTER to exit the adjustment.

---



### **Note**

- The following operations are available even if the buttons are locked:
    - Turning on or off the monitor with the Power button
  - Does not lock the remote control operation.
- 

## 3-5. Showing and hiding the EIZO logo

When the monitor is turned on, the EIZO logo appears on the screen. You can choose to show or hide the display of the EIZO logo.

### **Procedure**

1. Choose “Monitor Settings” in the Setting menu, and press ENTER.
2. Choose “Logo” in the “Monitor Settings” menu, and press ENTER.  
The “Logo” menu appears.
3. Select “On” or “Off” with  or .
4. Press ENTER to exit the adjustment.



## 3-6. Setting Language

This function allows you to select a language for the Setting menu or messages.

### **Selectable languages**

English, German, French, Spanish, Italian, Swedish, Japanese, Simplified Chinese, Traditional Chinese

### **Procedure**

1. Choose “Monitor Settings” in the Setting menu, and press ENTER.
2. Choose “Language” in the “Monitor Settings” menu, and press ENTER.  
The “Language” menu appears.
3. Choose a language with  or .
4. Press ENTER to exit the adjustment.

## 3-7. Changing the authentication method for HDMI signal input

The external device cannot be authenticated successfully according to your external device and the screen cannot be displayed. In this case, follow the procedures below to change the authentication method.



### Procedure

1. Press POWER on the remote control or  $\odot$  on the monitor to turn OFF the monitor power.
2. Press SIGNAL on the monitor for five seconds or more.

The authentication method changes and the monitor power is turned on.

### Note

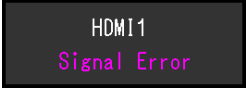
- The current authentication method can be identified based on the color used to display the input port or signal error.

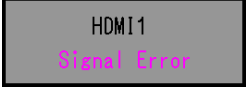
| Method                 | Input port  | Signal Error   |
|------------------------|---|--|
| 1<br>(Default setting) |  |  |
| 2                      |  |  |

## 3-8. Resetting the Monitor to the Default Settings

There are two different Resets: Color Reset for only resetting the color adjustments to the default settings and Full Reset for resetting all settings to the defaults.

### Attention

- After resetting, you cannot undo the operation.



### Note

- Regarding the default setting, see [“Main Default Settings” \(page 54\)](#).

### ● To reset the color adjustments

This function only resets the color adjustments for the currently selected mode to the default settings.

### Procedure

1. Choose “Color” in the Setting menu, and press ENTER.
2. Choose “Color Reset” in the “Color” menu, and press ENTER.
3. Select “Yes” with  or .
4. Press ENTER.

The color adjustments revert to the default settings.

## ● To reset all adjustments to the default settings



This function resets all adjustments to the default settings.

---

**Attention**

- The reset operation cannot return the authentication method for HDMI signal input ([“3-7. Changing the authentication method for HDMI signal input” \(page 30\)](#)) and the exiting method from the power saving mode ([“To change the exiting method from the power saving mode” \(page 36\)](#)) to the default setting.
- 

**Procedure**

1. Choose “Monitor Settings” in the Setting menu, and press ENTER.
2. Choose “Reset” in the “Monitor Settings” menu, and press ENTER.
3. Select “Yes” with  or .
4. Press ENTER.

All adjustments revert to the default settings.



# Chapter 4 Using Smart Function

## 4-1. Setting “Smart Detection”

This function allows you to select the area on the screen to which the “Smart Resolution” or “Smart Insight 2” setting is applied (only animated images or whole screen).

| Setting     | Function  |
|-------------|---|
| Video       | Detects the animated images on the screen, and applies the setting only to the detected area. |
| Full Screen | Applies the setting to the whole screen.  |

### Procedure

1. Press Smart on the remote control.  
The “Smart Functions” menu appears.
2. Select “Smart Detection”, and press ENTER.  
The “Smart Detection” menu appears.
3. Select “Video” or “Full Screen” with  or .
4. Press ENTER to exit.

---

### Note

- Under the following conditions, the setting for “Smart Detection” is fixed to “Full Screen”.
    - At interlace signal input
    - “Cinema” is selected from the color mode.
  - “Full Screen” should be set to display animated images using the whole screen.
-

## 4-2. Setting “Smart Resolution”

---





This function adjusts the perceived resolution of the images so that the blurs are reduced and images are displayed vividly and clearly. In addition, you can correct the color of skin and text affected by the “Smart Resolution” settings.

- Skin Tone Enhancer: Detects the skin tone in the image, and corrects the skin tone to look natural.
- Text Enhancer: Detects the text in the image, and corrects the coloring of the text and blurring around the text.

### **Adjustable range**

1 - 5, Off

### **Procedure**

1. Press Smart on the remote control.  
The “Smart Functions” menu appears.
2. Select “Smart Resolution” with , and press ENTER.  
The “Smart Resolution” menu appears.
3. Set the correction level with  or .
4. To complete the setting, proceed to step 7.  
To continuously set “Skin Tone Enhancer” and “Text Enhancer”, proceed to step 5.
5. Choose the item to correct, and press ENTER.  
Each setting menu appears.
6. Select “Enable” or “Disable” with  or .
7. Press ENTER to exit.

---

### **Attention**

- When “Smart Resolution” is set to “Off”, “Skin Tone Enhancer” and “Text Enhancer” cannot be selected.
  - “Text Enhancer” is enabled only when all the conditions below are met.
    - At non-interlace signal input
    - The screen is not enlarged using the Screen Size function (see [“2-5. Screen Size Changing” \(page 24\)](#)).
-

## 4-3. Setting “Smart Insight 2”

This function analyzes the image and corrects the brightness for each pixel to make dark area of images visible. It also increases the color saturation.

It is effective for images with dark area that are less visible and for bright environments.

### Attention

- “Smart Insight 2” detects the displayed scenes and corrects the screen brightness automatically. Therefore, the brightness may change slowly, for example, during scene transitions.

### Adjustable range



The adjustable range changes according to the display mode ([page 16](#)).

- User1, User2, Cinema, Web/sRGB, Paper  
1 - 5, Off
- Game (Dark scene), Game (Light scene)  
RTS (Low), RTS (Medium), RTS (High)/FPS (Low), FPS (Medium), FPS (High), Off

### Note

- When “Game (Dark scene)” or “Game (Light scene)” are selected from the color mode, adjust the settings according to the game to display (RTS, FPS) and the correction level (Low to High).
- When playing games other than the RTS and FPS types, change the setting as desired. The correction level is increased in the following order; “RTS (Low)” → “RTS (Medium)” → “RTS (High)/FPS (Low)” → “FPS (Medium)” → “FPS (High)”.



### Procedure

1. Press Smart on the remote control.  
The “Smart Functions” menu appears.
2. Select “Smart Insight 2” with , and press ENTER.  
The “Smart Insight 2” menu appears.
3. Set the correction level with  or .
4. Press ENTER to exit.





## 4-4. Checking the setting status

The setting status of the “Smart Functions” menu can be checked on the demo screen.

### Switching to the demo mode

1. Press  or  for 2 seconds or more while the “Smart Functions” menu is displayed.  
The screen is switched to the demo mode.
  - Left half of screen: The settings of the “Smart Functions” menu are applied.
  - Right half of screen: The settings of the “Smart Functions” menu are not applied.

### Note

- During the demo mode, the “Smart Functions” menu can be displayed to change each setting. If any of the Smart, MENU, , and  buttons is pressed, the menu appears.
- When “Smart Detection” is set to “On”, the magenta colored frame that covers the area detected as an animated image appears.
- To return to normal display from the demo screen, press  or  for 2 seconds or more while the “Smart Functions” menu is displayed.

# Chapter 5 Power Saving Functions

## 5-1. Setting Power Saving

### ● Monitor

This function allows you to specify whether to set the monitor into the power saving mode, depending on the state of an external device connected to it. When the monitor has shifted to the power saving mode, the images on the screen are not displayed.



#### Attention

- When not using the monitor, you can turn off the main power supply or disconnect the power plug so that the power is cut completely.
- Power consumption varies even when the stereo mini jack cable is connected.

#### Note

- The monitor changes to the power saving mode about 15 seconds after the signal input ceases to be detected.

#### Procedure

1. Choose "PowerManager" in the Setting menu, and press ENTER.
2. Choose "Power Save" in the "PowerManager" menu, and press ENTER.  
The "Power Save" menu appears.
3. Select "Enable" or "Disable" with  or .
4. Press ENTER to exit the adjustment.

#### Power Saving System

##### When the external device connected is a PC

This monitor complies with the DVI DMPM standard.

| PC                | Monitor           | Power Indicator |
|-------------------|-------------------|-----------------|
| On                | Operating         | White           |
| Power saving mode | Power saving mode | Orange          |
| Power Off         | Power saving mode | Orange          |

##### When the external device connected is not a PC

| Ext. Device | Monitor           | Power Indicator |
|-------------|-------------------|-----------------|
| Power On    | Operating         | White           |
| Power Off   | Power saving mode | Orange          |

#### Attention

- When all the conditions below are met, the monitor does not change to the power saving mode even if "Power Save" is set to "Enable":
  - "Power Save" for Sound is set to "Sound On" ("[Audio Output](#)" (page 36))
  - In the mute state ("[To mute the sound temporarily](#)" (page 28))In these cases, reset the mute.

#### Exiting the power saving mode



If the monitor receives input, it automatically exits the power saving mode and returns to the normal display mode.

## ● To change the exiting method from the power saving mode

Change the method of exiting from the power saving mode in the following cases.

- To reduce the time for exiting from the power saving mode
- The screen is not displayed when a signal is input to the monitor.
- The monitor does not change to the power saving mode.

### **Procedure**

1. Press POWER on the remote control or  on the monitor to turn OFF the monitor power.
2. Press **Vol**  on the monitor for five seconds or more.  
The exiting method changes and the monitor power is turned on.

---

### **Attention**

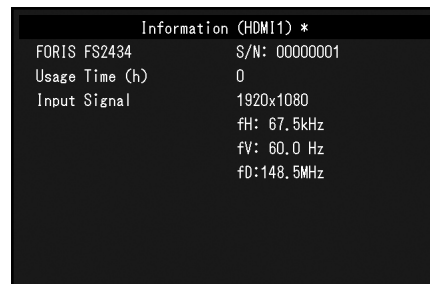

- After the exiting method is changed, the power consumption during the power saving mode increases slightly. In addition, “\*” is displayed on the menu title of “Information” of the Setting menu (see “8-5. Displaying Monitor Information” (page 52)).



## ● Audio Output

This monitor allows you to turn off the audio output from the speakers/headphone at the power saving mode.

### **Procedure**

1. Choose “Sound” in the Setting menu, and press ENTER.
2. Choose “Power Save” in the “Sound” menu, and press ENTER.  
The “Power Save” menu appears.
3. Select “Sound On” or “Sound Off” with  or .
4. Press ENTER to exit the adjustment.

---

### **Attention**

- No audio is output while the monitor is in the Power Saving mode, if the HDMI signal is input or the sound source is of HDMI.
  - Audio output is suppressed when all of the following conditions are met:
    - Input signal is HDMI.
    - The sound source is set to “HDMI” in the “Sound” settings.
    - The monitor is switched to the power saving mode.
-



## ● USB



In case you do not use the “G-Ignition” software for screen adjustment, this function allows you to save power consumption while the screen is turned off or in power saving mode.

---

### Attention

- When “G-Ignition” is installed, the “USB Power Save” setting will automatically switch to “Disable”.
  - It is possible to use the USB hub function regardless of this setting.
- 

### Procedure



1. Choose “Monitor Settings” in the Setting menu, and press ENTER.
2. Choose “USB Power Save” in the “Monitor Settings” menu, and press ENTER.  
The “USB Power Save” menu appears.
3. Select “Enable” or “Disable” with  or .
4. Press ENTER to exit the adjustment.

## 5-2. Setting Power Indicator

---

This function allows you to set the power indicator (white) ON/OFF in the monitor ON condition.

### Procedure

1. Choose “Monitor Settings” in the Setting menu, and press ENTER.
2. Choose “Power Indicator” in the “Monitor Settings” menu, and press ENTER.  
The “Power Indicator” menu appears.
3. Select “Enable” or “Disable” with  or .
4. Press ENTER to exit the adjustment.

## 5-3. Enabling/Disabling Automatic Brightness Adjustment “Auto EcoView”

---



The ambient light sensor on the front side of the monitor detects the environmental brightness to adjust the screen brightness automatically and comfortably by using the Auto EcoView function.

---

### Attention

- Be careful not to block the sensor on the lower side of the monitor when using the Auto EcoView function.
- 

### Procedure

1. Press EcoView on the remote control.
2. Choose “Auto EcoView” in the “EcoView Menu” menu, and press ENTER.  
The “Auto EcoView” menu appears.
3. Select “High”, “Standard”, or “Off” with  or .
4. Press ENTER to exit.

---

### Note

- As “Brightness” in the Setting menu is changed, the auto adjustment range for Auto EcoView is also changed.
  - Set to “High” if you feel a little brighter with “Standard” setting status.
-

## 5-4. Reducing Glare “EcoView Optimizer”

Using EcoView Optimizer adjusts the screen brightness according to the environment brightness and white level of the input signal. Using this function with Auto EcoView can create a more comfortable level of brightness and reduce glare.

### Procedure

1. Press EcoView on the remote control.
2. Choose “EcoView Optimizer” in the “EcoView Menu” menu, and press .  
The “EcoView Optimizer” menu appears.
3. Select “On” or “Off” with ◀ or ▶.
4. Press ENTER to exit.

### Attention

- Be careful not to block the ambient light sensor on the lower side of the monitor when using the EcoView Optimizer function.

## 5-5. Checking the power saving level

The EcoView menu allows you to check Power Reduction, CO<sub>2</sub> Reduction, and Eco Performance Level. The more indicators light up representing the Eco Performance Level, the higher the power saving level attained.

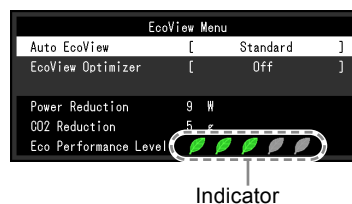

### Procedure

1. Press EcoView on the remote control.  
The “EcoView Menu” appears.

### Note

- Power reduction: the backlight’s reduction of power consumption as a result of the adjusted brightness value.  
CO<sub>2</sub> reduction: converted from the “Power reduction” value, this is an estimate of the quantity of CO<sub>2</sub> emissions reduced when using the monitor for 1 hour.
- \* The numeric value is a result of a calculation based on a default setting (0.000555 t -CO<sub>2</sub>/kWh) determined by a Japanese ministerial ordinance (2006, Ministry of Economy, Trade and Industry, Ministry of Environment, civil code article 3) and may differ depending on country and year.

## 5-6. Enabling/Disabling Auto Power-OFF “Off Timer”

This function allows you to set the time to power off the monitor automatically.

### **Adjustable range**

Disable, 30, 60, 90, 120, 150, 180 min

### **Procedure**

1. Press OFF TIMER on the remote control.  
Each time you press OFF TIMER, the set time changes.

### **Canceling procedure**

1. Press OFF TIMER until “Disable” appears.

### **Checking the remaining time**

1. Press OFF TIMER when the Off Timer is set.  
The time to turn off the power appears.

### **Time extension procedure**

1. Press OFF TIMER while the remaining time is displayed.  
Each time you press OFF TIMER, the time is extended.

# Chapter 6 Connecting Cables

## 6-1. Connecting Multiple External Devices

The product has multiple connections to external devices and allows you to switch to one of the connections for display.

**Attention**

- Do not use dual link cables.

### Connection examples

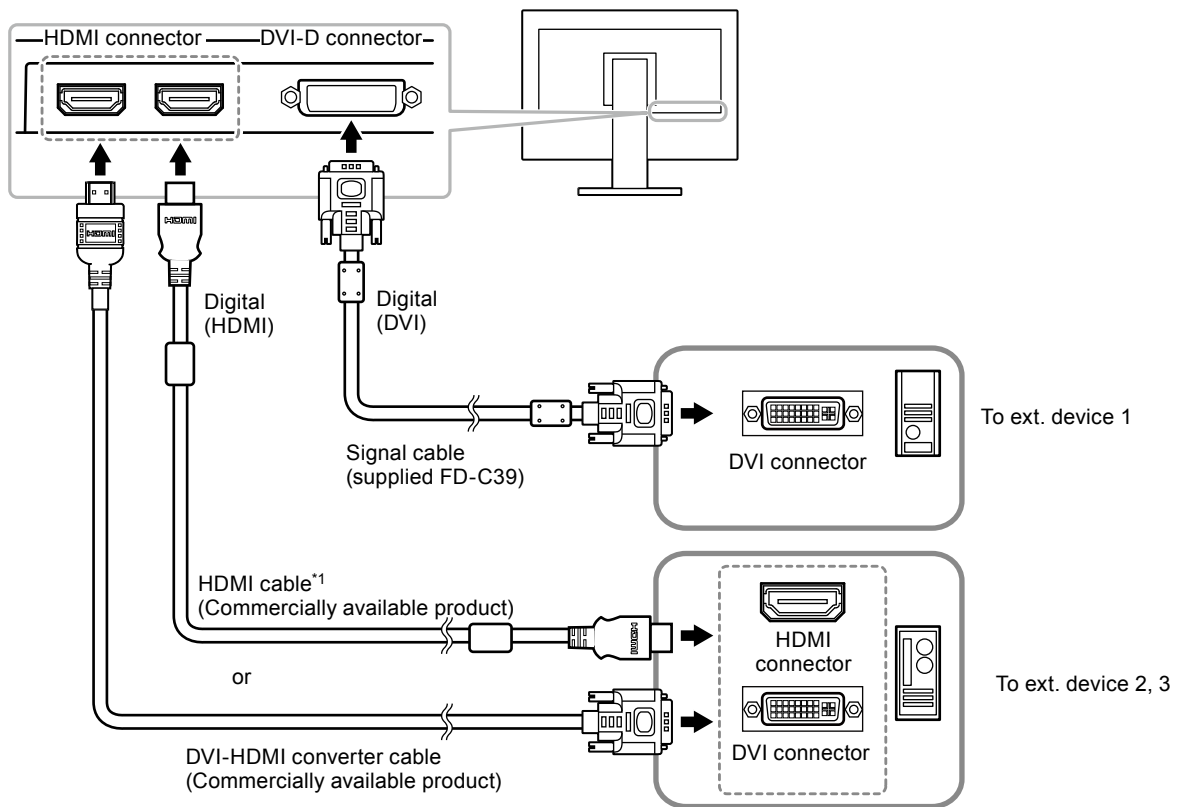

\*1 Use a product able to handle High Speed.

### ● To switch among input signals

Press P C or HDMI on the remote control to change the input signal.

When the signal is switched, the active input port name appears at the top right corner of the screen.

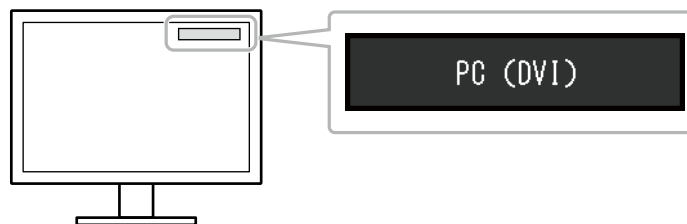

**Note**

- **SIGNAL** on the monitor also can change the input (see "1-2. Controls and Functions" (page 8)).

## 6-2. Connecting External Speaker

A speaker with built-in amplifier can be connected to this product to output sound from external devices such as PCs and game players.

### Connection examples

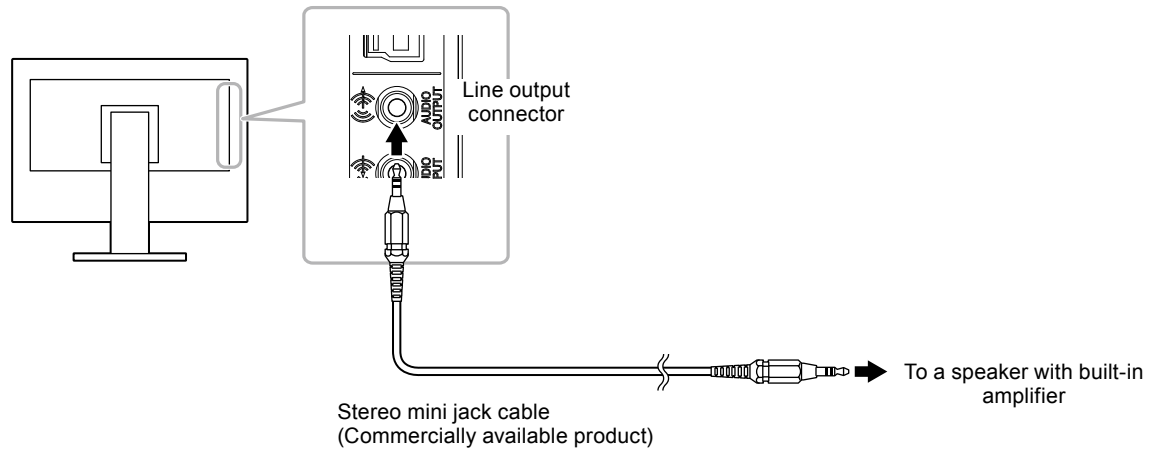

#### Attention

- Adjust the volume on the external speaker. You cannot adjust the volume using the remote control or control buttons on the monitor.
- When a speaker with built-in amplifier is attached to the line output connector, the monitor speaker does not output any sound.
- When headphones are connected to the monitor while a speaker with built-in amplifier is attached to the line output connector, the speaker with built-in amplifier does not output any sound.

# Chapter 7 Troubleshooting

If a problem still remains after applying the suggested remedies, contact your local EIZO representative.

## 7-1. No picture

| Problem   | Possible cause and remedy   |
|---|---|
| <b>1. No picture</b> <ul style="list-style-type: none"> <li>Power indicator does not light.</li> </ul>  | <ul style="list-style-type: none"> <li>Check whether the power cord is connected properly.</li> <li>Turn the main power switch on.</li> <li>Turn off the main power, and then turn it on again a few minutes later.</li> </ul>  |
| <ul style="list-style-type: none"> <li>Power indicator is lighting red.</li> </ul>  | <ul style="list-style-type: none"> <li>Press POWER on the remote control (or  on the monitor).</li> </ul>  |
| <ul style="list-style-type: none"> <li>Power indicator is lighting white.</li> </ul>  | <ul style="list-style-type: none"> <li>Increase “Brightness”, “Contrast”, or “Gain” in the Setting menu (see <a href="#">“To perform advanced adjustments” (page 17)</a>).</li> </ul>   |
| <ul style="list-style-type: none"> <li>Power indicator is lighting orange.</li> </ul>   | <ul style="list-style-type: none"> <li>Check whether the signal cable is connected properly.</li> <li>Check whether the external device is turned on.</li> <li>Operate the mouse or keyboard.</li> <li>Switch the input signal.</li> <li>If an external device is connected, change the method of exiting from the power saving mode. Turn off the power once and then press <b>Vol</b> — on the monitor for five seconds or more to change the exiting method and then turn on the power again (see <a href="#">“To change the exiting method from the power saving mode” (page 36)</a>).</li> <li>If an external device is plugged into the HDMI port, change the authentication method. Power off once and then press <b>SIGNAL</b> on the monitor for five seconds or more to change the authentication method and then turn on the power again (see <a href="#">“3-7. Changing the authentication method for HDMI signal input” (page 30)</a>).</li> </ul> |
| <b>2. The message below appears.</b>  | This message appears when the signal is not input correctly even when the monitor functions properly.   |
| Example: <div data-bbox="336 1391 603 1487" style="border: 1px solid black; background-color: #333; color: white; padding: 5px; text-align: center; margin: 10px auto; width: fit-content;">             PC (DVI)<br/>Signal Error           </div> | <ul style="list-style-type: none"> <li>The message shows that the input signal is out of the specified range.</li> <li>Check the following corrective actions when inputting DVI-D, or HDMI (PC signals).               <ul style="list-style-type: none"> <li>Check whether the PC is configured to meet the resolution and vertical scan frequency requirements of the monitor (see <a href="#">“2-1. Compatible Resolutions/Formats” (page 14)</a>).</li> <li>Reboot the PC.</li> <li>Select an appropriate setting using the graphics board’s utility. Refer to the manual of the graphics board for details.</li> </ul> </li> </ul>  |

## 7-2. Imaging problems

| Problem  | Possible cause and remedy  |
|--|--|
| 1. The screen is too bright or too dark.                             | <ul style="list-style-type: none"> <li>Use “Brightness” or “Contrast” in the Setting menu to adjust it (see <a href="#">“To perform advanced adjustments”</a> (page 17)). (The LCD monitor backlight has a limited life span. When the screen becomes dark or begins to flicker, contact your local EIZO representative.)</li> <li>If the screen is too bright, turn on Auto EcoView and EcoView Optimizer (see <a href="#">“5-3. Enabling/Disabling Automatic Brightness Adjustment “Auto EcoView””</a> (page 37), <a href="#">“5-4. Reducing Glare “EcoView Optimizer””</a> (page 38)). The monitor detects the environmental brightness to adjust the screen brightness automatically.</li> </ul> |
| 2. Characters are blurred.   | <ul style="list-style-type: none"> <li>Check whether the PC is configured to meet the resolution and vertical scan frequency requirements of the monitor (see <a href="#">“2-1. Compatible Resolutions/Formats”</a> (page 14)).</li> <li>Use “Smoothing” in the Setting menu to adjust it (see <a href="#">“To modify blurred characters/lines”</a> (page 26)).</li> </ul>   |
| 3. Afterimages appear.   | <ul style="list-style-type: none"> <li>Afterimages are particular to LCD monitors. Avoid displaying the same image for a long time.</li> <li>Use the screen saver or power save function to avoid displaying the same image for extended periods of time.</li> </ul>   |
| 4. Green/red/blue/white dots or defective dots remain on the screen. | <ul style="list-style-type: none"> <li>This is due to LCD panel characteristics and is not a failure.</li> </ul>   |
| 5. Interference patterns or pressure marks remain on the screen.     | <ul style="list-style-type: none"> <li>Leave the monitor with a white or black screen. The symptom may disappear.</li> </ul>   |
| 6. Noise appears on the screen.                                      | <ul style="list-style-type: none"> <li>In the Setting menu, set “Overdrive” to “Off” (see <a href="#">“To set overdrive intensity”</a> (page 22)).</li> <li>When entering the HDCP signals, the normal images may not be displayed immediately.</li> </ul>   |
| 7. The screen is whitish or blackish.                                | <ul style="list-style-type: none"> <li>Use “Black Level” (see <a href="#">“To Adjust Black Level “Black Level””</a> (page 18)), and “Contrast” (see <a href="#">“To adjust contrast”</a> (page 18)) in the Setting menu to adjust it.</li> </ul>   |
| 8. The color shown on the display is not correct (for HDMI input).   | <ul style="list-style-type: none"> <li>Change the color space of the video signal in “Screen” – “Color Space” under the Setting menu.(see <a href="#">“2-4. Setting the Color Space for the HDMI input signal”</a> (page 23))</li> </ul>   |
| 9. The screen flashes (for HDMI input).                              | <ul style="list-style-type: none"> <li>Transmittable signals differ on the category of the HDMI cable. Check whether the cable support High Speed.</li> </ul>  |
| 10. The screen is whitish or blackish (for HDMI input).              | <ul style="list-style-type: none"> <li>Use “Screen” – “Color Space” under the Setting menu to adjust it.(see <a href="#">“2-4. Setting the Color Space for the HDMI input signal”</a> (page 23))</li> </ul>  |

## 7-3. Other problems

| Problem   | Possible cause and remedy  |
|---|--|
| <p>1. The “Smoothing” on the Setting menu “Screen” cannot be selected.</p>  | <ul style="list-style-type: none"> <li>• You cannot choose “smoothing” when the screen is displayed in the following resolutions or settings.               <ul style="list-style-type: none"> <li>- The resolution is 1920 × 1080</li> <li>- Screen Size is “Normal”</li> </ul> </li> </ul>   |
| <p>2. No audio output.</p>  | <ul style="list-style-type: none"> <li>• Check whether the stereo mini jack cable is connected properly.</li> <li>• Check the current external device and audio playback software to see whether they are configured correctly.</li> <li>• If HDMI input is used, check the current external device and the “Source” setting in the Setting menu (see “3-1. Switching sound source for HDMI signal input” (page 27)).</li> <li>• Monitor speaker               <ul style="list-style-type: none"> <li>- Check whether a speaker with built-in amplifier is attached to the line output connector.</li> <li>- Check whether volume is set to 0.</li> </ul> </li> <li>• Headphones               <ul style="list-style-type: none"> <li>- Check whether volume is set to 0.</li> </ul> </li> <li>• Speaker with built-in amplifier attached to the line output connector               <ul style="list-style-type: none"> <li>- Check whether the headphones are connected.</li> </ul> </li> </ul> |
| <p>3. The volume of the speaker with built-in amplifier attached to the line output connector cannot be adjusted.</p> | <ul style="list-style-type: none"> <li>• With this product, the volume of an external speaker cannot be adjusted. Adjust the volume on the external speaker.</li> </ul>  |
| <p>4. Will not change to the power saving mode</p>  | <ul style="list-style-type: none"> <li>• When all the conditions below are met, the monitor does not change to the power saving mode even if “Power Save” is set to “Enable”:               <ul style="list-style-type: none"> <li>- “Power Save” for Sound is set to “Sound On” (“Audio Output” (page 36))</li> <li>- In the mute state (“To mute the sound temporarily” (page 28))</li> <li>- In these cases, reset the mute.</li> </ul> </li> <li>• Perform the procedure described under “To change the exiting method from the power saving mode” (page 36).</li> </ul>   |
| <p>5. “This operation is not available on current status.” is displayed.</p>  | <ul style="list-style-type: none"> <li>• This message appears in the following cases.               <ul style="list-style-type: none"> <li>- When VOLUME+ / VOLUME– on the remote control or <b>Vol + / Vol –</b> on the monitor is pressed: The volume of the speaker with built-in amplifier attached to the line output connector cannot be adjusted (see “3-2. Adjusting Volume” (page 27)).</li> <li>- When Smart on the remote control is pressed: When “Web/sRGB” is selected as color mode, the Smart function cannot be used (see “Chapter 4 Using Smart Function” (page 32)).</li> </ul> </li> </ul>   |



| Problem  | Possible cause and remedy  |
|--|--|
| <p><b>6. USB devices connected to the monitor do not work.</b></p> | <ul style="list-style-type: none"> <li>• Check whether the USB cable is connected correctly (see <a href="#">“8-4. Making Use of USB (Universal Serial Bus)”</a> (page 51)).</li> <li>• Change the USB port to another one. If the PC or peripheral devices works correctly by changing the USB port, contact your local EIZO representative. (Refer to the manual of the PC for details.)</li> <li>• Reboot the PC.</li> <li>• If the peripheral devices work correctly when the PC and peripheral devices are connected directly, please contact your local EIZO representative.</li> <li>• Check whether the PC and OS are USB compliant. (For USB compliance of the respective devices, consult their manufacturers.)</li> <li>• Check the PC’s BIOS setting for USB when using Windows. (Refer to the manual of the PC for details.)</li> </ul> |

# Chapter 8 Reference

## 8-1. How to Attach the Optional Arm

An optional arm (or an optional stand) can be attached by removing the stand section. Please refer to our web site for the corresponding optional arm (or optional stand). <http://www.eizoglobal.com>

### Attention

- When attaching an arm or stand, follow the instructions of their user's manual.
- When using another manufacturer's arm or stand, confirm the following in advance and select one conforming to the VESA standard. Use the M4 × 12 mm screws supplied with this product.
  - Clearance between the screw holes: 100 mm × 100 mm
  - Thickness of plate: 2.6 mm
  - Strong enough to support weight of the monitor unit (except the stand) and attachments such as cables.
- When using an arm or stand, attach it to meet the following tilt angles of the monitor.
  - Up 45°, down 45° (horizontal display, and vertical display rotated 90 degrees clockwise)
- Connect the cables after attaching an arm or stand.
- The monitor and arm or stand are heavy. Dropping them may result in injury or equipment damage.

### Procedure

**1. Lay the LCD monitor on a soft cloth spread over on a stable surface with the panel surface facing down.**

**2. Remove the stand.**

1. Remove the cover.

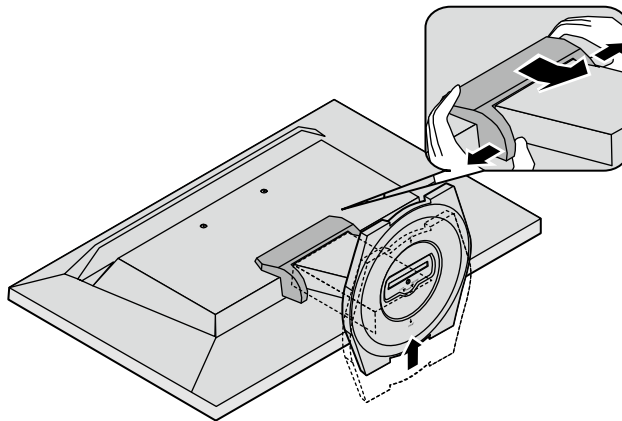

2. Using a screwdriver, remove the screws (three) securing the unit and the stand.

**3. Remove the caps (two) on the screw holes using the tip of a pen.**

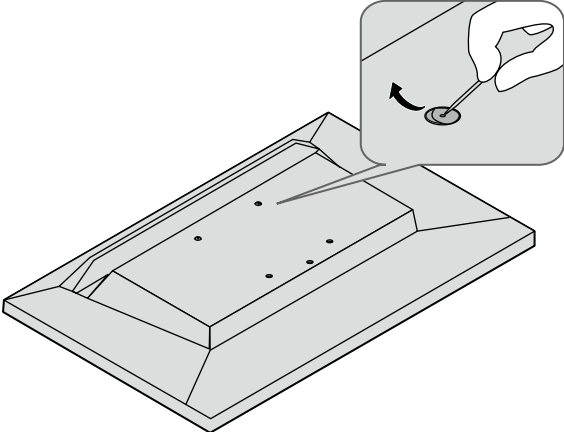

**4. Attach the arm or stand to the monitor.**

Secure the monitor to the arm or stand using the screws specified in the user's manual of the arm or stand.

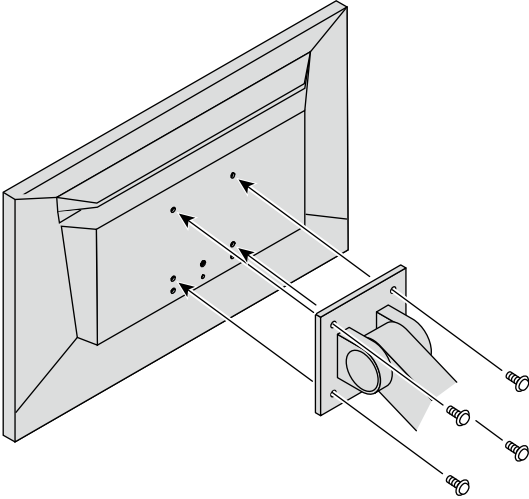

## 8-2. Detaching/Attaching Stand Base

### Detaching procedure

The Stand base that was attached during setup can be detached using the following procedures.

- 1. Lay the LCD monitor on a soft cloth spread over on a stable surface with the panel surface facing down.**
- 2. Turn the fixing screw for the Stand base in the “RELEASE” direction to detach the base.**

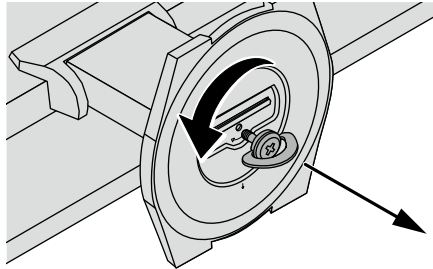

- 3. Remove the Stand base while lifting it up.**

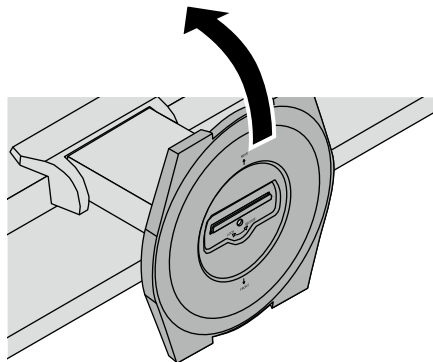

## Attaching procedure

The once removed the Stand base can be attached to the monitor again with the following procedures.

- 1. Lay the LCD monitor on a soft cloth spread over on a stable surface with the panel surface facing down.**
- 2. Hold the Stand base with the “REAR” side facing upward, align the hole (a) of the Stand base with the tab (b) at the bottom of the monitor, and snap the tab into the hole.**

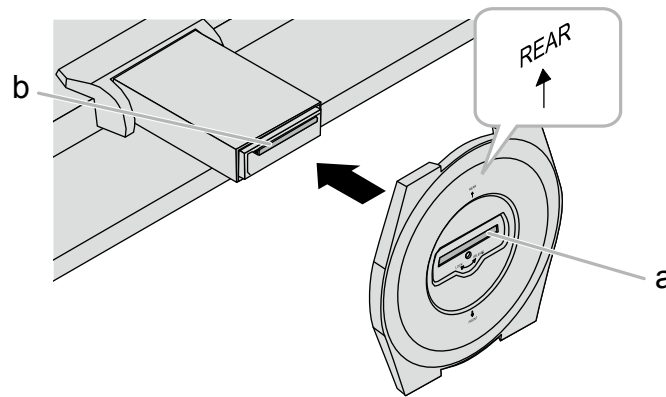

- 3. Turn the supplied screw in the “LOCK” direction to lock the Stand base.**

Tighten the screw firmly to the end.

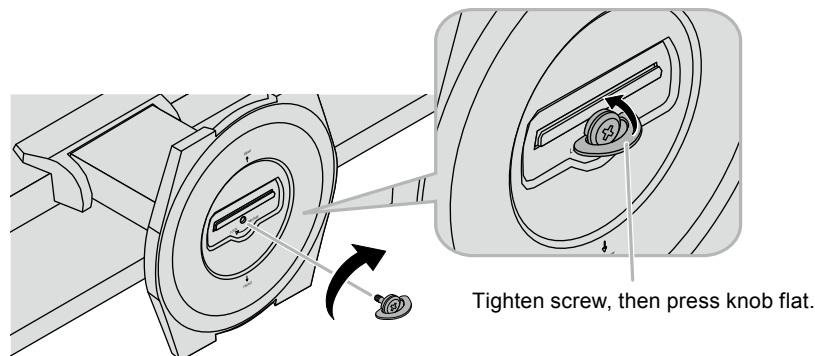

- 4. Place the monitor on a stable surface.**

## 8-3. Attaching/Detaching Cable Holder

A cable holder is supplied with this product. Use the holder to organize the cables connected to the monitor.

### Attaching procedure

1. Pass the cables through the cable holder.
2. Shut the bottom of the cable holder.

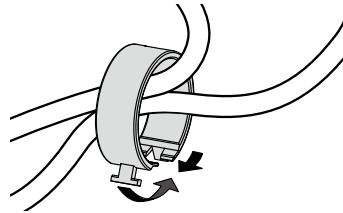

3. While holding the shut section, insert the cable holder into the Stand base.

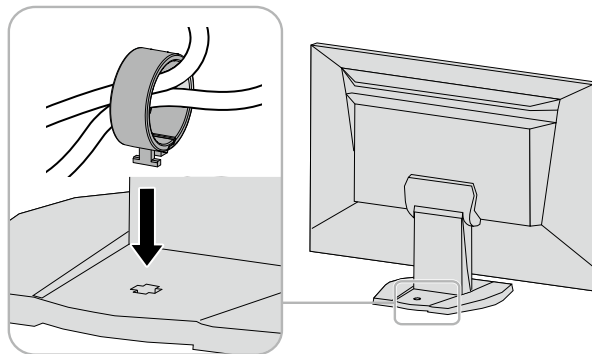

---

#### Note

- The cable holder can be inserted either perpendicular or parallel to the base. Change the direction of the cable holder according to the conditions of the cables.

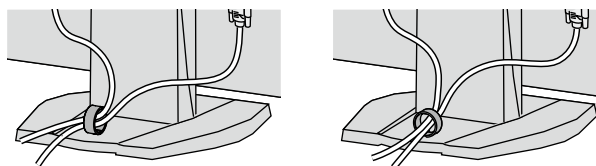

## Detaching procedure

1. Shut the bottom of the cable holder.
2. While holding the shut section, lift the cable holder upward to remove it from the Stand base.

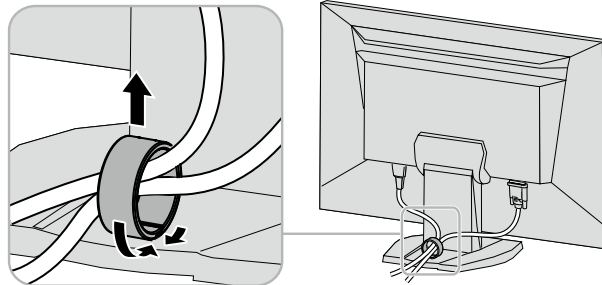

## 8-4. Making Use of USB (Universal Serial Bus)

This product is equipped with a USB hub. Connected to a PC compatible with USB, this monitor functions as a USB hub allowing connection to peripheral USB devices.

### Note

- This product supports USB 3.0. When connecting peripheral devices that support USB 3.0, high-speed data communication is possible (however, only when the USB cable used to connect the PC and peripheral device is USB 3.0 compliant).

### ● Required System Environment

- A PC equipped with a USB port.
- Windows 10 / Windows 8.1 / Windows 7 / Windows Vista or Mac OS X 10.2 or later and Mac OS 9.2.2
- EIZO USB cable (UU200SS (USB 3.0))

### Attention

- This monitor may fail to work depending on the PC, OS or peripheral devices to be used. For the USB compatibility of peripheral devices, contact their manufacturers.
- When the monitor is in the power saving mode, devices connected to the USB downstream port will still work. Therefore, the power consumption of the monitor varies with the connected devices even in the power saving mode.
- When the main power switch is turned off, devices connected to USB downstream ports do not work.

### ● Connection procedure (Setup of USB function)

1. Connect the monitor first to a PC using the signal cable, and run the PC.
2. Using the USB cable, connect the downstream port of a PC compatible with USB and the monitor's upstream port.

The USB hub function is set up automatically upon connection of the USB cable.

3. Connect the peripheral USB device to the USB downstream port of the monitor.

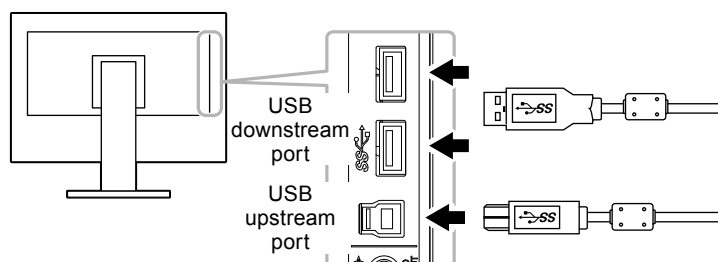

## 8-5. Displaying Monitor Information

---

This function allows you to display the model name, serial number, usage time, resolution, and input signal.

### **Procedure**

1. Choose “Information” in the Setting menu, and press ENTER.

The “Information” menu appears.

---

### **Attention**

- When you turn on the monitor for the first time, the usage time may be more than 0 due to a factory inspection.
-



## 8-6. Specifications

|                            |                                       |  |
|----------------------------|---------------------------------------|--|
| LCD Panel                  | Type                                  | IPS (Anti-Glare)   |
|                            | Backlight                             | LED  |
|                            | Size                                  | 60 cm (23.8 inch) (60.4 cm diagonal)   |
|                            | Resolution                            | 1920 dots × 1080 lines   |
|                            | Display Size (H x V)                  | 527.04 mm×296.46 mm  |
|                            | Pixel Pitch                           | 0.2745 mm  |
|                            | Display Colors                        | 8-bit colors : 16.77 million colors  |
|                            | Viewing Angles<br>(H x V, typical)    | 178 °, 178 °   |
|                            | Maximum Brightness                    | 250 cd/m <sup>2</sup>  |
|                            | Response Time<br>(typical)            | 16 ms (Black-white-black)<br>4.9 ms (Gray-to-gray) <sup>*1</sup> (Overdrive setting: Enhanced)   |
|                            | Contrast Ratio                        | 1000:1 (when ContrastEnhancer setting is "Enhanced" 5000:1)  |
| Video Signals              | Input Terminals                       | DVI-D connector (HDCP) × 1, HDMI Type A <sup>*2</sup> × 2  |
|                            | Digital Scanning Frequency<br>(H / V) | DVI : 31 kHz - 68 kHz / 59 Hz - 61 Hz<br>(720 × 400: 69 Hz - 71 Hz)<br>HDMI : 15 kHz - 68 kHz / 49 Hz - 61 Hz<br>Frame synchronous mode :49 Hz - 61 Hz |
|                            | Video Input Format                    | VGA / 480i / 480p / 1080i / 720p / 1080p: 60 Hz<br>576i / 576p / 1080i / 720p / 1080p: 50 Hz   |
|                            | Maximum Dot Clock                     | 148.5 MHz  |
| Audio                      | Audio Input Format (HDMI)             | 2ch linear PCM (32 kHz / 44.1 kHz / 48 kHz)  |
|                            | Speaker output                        | 0.5 W + 0.5 W (8 Ω)  |
|                            | Headphones                            | 2 mW+2 mW (32 Ω)   |
|                            | Input Terminals                       | Line: Stereo mini jack × 1   |
|                            |                                       | HDMI Type A <sup>*2</sup> × 2 (Shared with video signals)  |
|                            | Output Terminals                      | Headphone: Stereo mini jack × 1  |
| Line: Stereo mini jack × 1 |                                       |  |
| USB                        | Port                                  | Upstream port × 1, Downstream port × 2   |
|                            | Standard                              | USB Specification Rev.3.0  |
|                            | Communication Speed                   | 5 Gbps (super), 480 Mbps (high),12 Mbps (full), 1.5 Mbps (low)   |
|                            | Supply Current                        | Downstream: Max. 900 mA/1 port   |
| Power supply               | Input                                 | 100 - 120 VAC ±10 %, 50 / 60 Hz 0.80 A<br>200 - 240 VAC ±10 %, 50 / 60 Hz 0.50 A   |
|                            |                                       | Maximum Power Consumption  |
|                            | Power Save Mode                       | 0.5 W or less (no USB device is connected, and "USB Power Save" is set to "Enable")  |
|                            | Standby Mode                          | 0.5 W or less (when no USB device is connected)  |
| Physical Specifications    | Dimensions                            | 539.4 mm × 390 - 458.3 mm × 200 mm ( W × H × D )   |
|                            | Dimensions (Without Stand)            | 539.4 mm ×344 mm × 52.5 mm ( W × H × D )   |
|                            | Net Weight                            | Approx. 5.2 kg   |
|                            | Net Weight (Without Stand)            | Approx. 4.0 kg   |
|                            | Height Adjustment Range               | 60 mm  |
|                            | Tilt                                  | 25 ° up, 0 ° down  |
|                            | Swivel                                | 344 °  |

|   |              |                                   |
|---|--------------|-----------------------------------|
| Operating<br>Environmental<br>Requirements                  | Temperature  | 5°C to 35°C (41°F to 95°F)        |
|   | Humidity     | 20% to 80% R.H. (no condensation) |
|   | Air pressure | 540 hPa to 1,060 hPa              |
| Transportation/<br>Storage<br>Environmental<br>Requirements | Temperature  | -20°C to 60°C (-4°F to 140°F)     |
|   | Humidity     | 10% to 90% R.H. (no condensation) |
|   | Air pressure | 200 hPa to 1,060 hPa              |

\*1 Average value of response time in the gray-to-gray area.

\*2 HDMI CEC (or mutual control) is not supported.

## Main Default Settings

|                           |   |
|---------------------------|---|
| Color Mode                | User1   |
| Off Timer                 | Disable   |
| Screen Size               | DVI-D input: Full screen<br>HDMI (PC signal/HD signal) input: Full screen<br>HDMI (SD signal) input: Auto |
| Auto EcoView              | Standard  |
| EcoView Optimizer         | Off   |
| Smoothing                 | 3   |
| Sound Level               | 0   |
| Sound - Power Save        | Sound Off   |
| PowerManager - Power Save | Enable  |
| Key Lock                  | Off   |
| Logo                      | On  |
| Power Indicator           | Enable  |
| Language                  | English   |
| USB Power Save            | Enable  |

## Outside Dimensions

Unit: mm

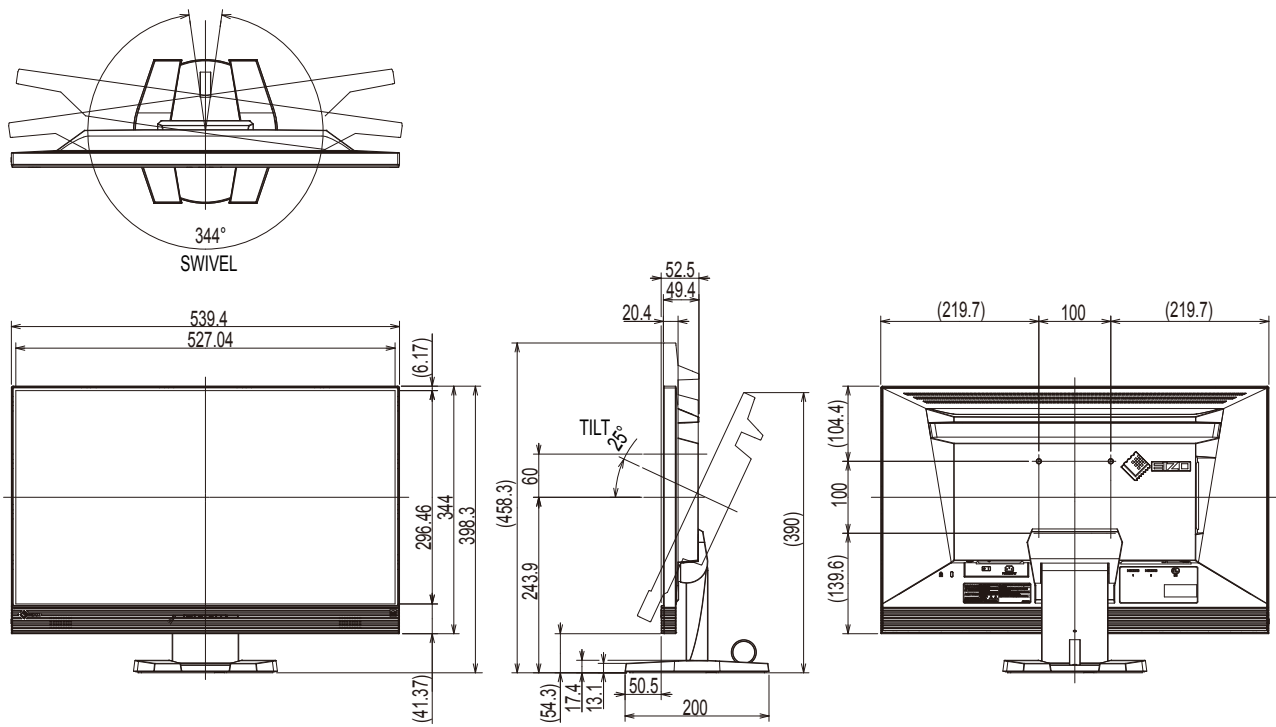

## Accessories

|              |                      |
|--------------|----------------------|
| Cleaning Kit | EIZO "ScreenCleaner" |
|--------------|----------------------|

For the latest information about the accessories, refer to our web site.  
<http://www.eizoglobal.com>

# Chapter 9 Glossary

## Color Space

YUV and RGB, etc. are available. YUV expresses the color by using the luminance (Y), the color difference of Blue (U), and the color difference of Red (V). RGB does this by using the gradation of the 3 colors, Red (R), Green (G), and Blue (B).

## DVI (Digital Visual Interface)

DVI is a digital interface standard. DVI allows direct transmission of the PC's digital data without loss.

This adopts the TMDS transmission system and DVI connectors. There are two types of DVI connectors. One is a DVI-D connector for digital signal input only. The other is a DVI-I connector for both digital and analog signal inputs.

## DVI DMPM (DVI Digital Monitor Power Management)

DVI DMPM is a digital interface power saving function. The "Monitor ON (operating mode)" and "Active Off (power saving mode)" are indispensable for DVI DMPM as the monitor's power mode.

## FPS (First Person Shooter)

This refers to shooting games where the player(s) moves through the world in the game with a first-person perspective as the main character, fighting enemies.

## Gain

This is used to adjust each color parameter for red, green and blue. An LCD monitor displays the color by the light passing through the panel color filter. Red, green and blue are the three primary colors. All the colors on the screen are displayed by combining these three colors. The color tone can be changed by adjusting the light intensity (volume) passing through each color's filter.

## Gamma

Generally, the monitor brightness varies nonlinearly with the input signal level, which is called "Gamma Characteristic". A small gamma value produces a low-contrast image, while a large gamma value produces a highcontrast image.

## HDCP (High-bandwidth Digital Content Protection)

Digital signal coding system developed to copy-protect the digital contents, such as video, music, etc.

This helps to transmit the digital contents safely by coding the digital contents sent via the DVI or HDMI connector on the output side and decoding them on the input side.

Any digital contents cannot be reproduced if both of the equipments on the output and input sides are not applicable to HDCP system.

## HDMI (High-Definition Multimedia Interface)

HDMI is a digital interface standard, developed for consumer electrical appliance or AV device.

This standard is issued on the basis of the DVI standard which is one of an interface specification for the connection between a PC and a monitor. The projected image, sound and control signal without compressed enable to be transmitted with one cable.

## **Overdrive**

This technology enhances response speed by increasing the potential difference at the time of motion of liquid-crystal pixels, and it is used for liquid-crystal TV sets and others in general. It provides clear-cut three-dimensional display with little afterimage, by improving response speed of the intermediate graduation range that frequently appears in moving images.

## **Resolution**

The LCD panel consists of numerous pixels of specified size, which are illuminated to form images. This monitor consists of horizontal 1920 pixels and 1080 vertical pixels. At a resolution of 1920 × 1080, all pixels are illuminated as a full screen (1:1).

## **RTS (Real-time Strategy)**

This refers to games where the player(s) competes while strategizing under conditions that progress in real time.

## **sRGB (Standard RGB)**

International standard for color reproduction and color space among peripheral devices (such as monitors, printers, digital cameras, scanners). As a form of simple color matching for the Internet, colors can be displayed using tones close to those of the transmission and reception devices.

## **Temperature**

Color temperature is a method to measure the white color tone, generally indicated in degrees Kelvin. The screen becomes reddish at a low temperature, and bluish at a high temperature, like the flame temperature.

5000 K: Slightly reddish white

6500 K: White referred to as daylight-balanced color

9300 K: Slightly bluish white

## **TMDS (Transition Minimized Differential Signaling)**

A signal transmission system for digital interface.

# Appendix

## Trademark

The terms HDMI and HDMI High-Definition Multimedia Interface, and the HDMI Logo are trademarks or registered trademarks of HDMI Licensing, LLC in the United States and other countries.

VESA is a registered trademark of Video Electronics Standards Association.

Acrobat, Adobe, Adobe AIR, and Photoshop are registered trademarks of Adobe Systems Incorporated in the United States and other countries.

AMD Athlon and AMD Opteron are trademarks of Advanced Micro Devices, Inc.

Apple, ColorSync, eMac, iBook, iMac, iPad, Mac, MacBook, Macintosh, Mac OS, PowerBook, and QuickTime are registered trademarks of Apple Inc.

ColorMunki, Eye-One, and X-Rite are registered trademarks or trademarks of X-Rite Incorporated in the United States and/or other countries.

ColorVision and ColorVision Spyder2 are registered trademarks of DataColor Holding AG in the United States.

Spyder3 and Spyder4 are trademarks of DataColor Holding AG.

ENERGY STAR is a registered trademark of the United States Environmental Protection Agency in the United States and other countries.

GRACoL and IDEAlliance are registered trademarks of International Digital Enterprise Alliance.

NEC is a registered trademark of NEC Corporation.

PC-9801 and PC-9821 are trademarks of NEC Corporation.

NextWindow is a trademark of NextWindow Ltd.

Intel, Intel Core, Pentium, and Thunderbolt are trademarks of Intel Corporation in the U.S. and/or other countries.

PowerPC is a registered trademark of International Business Machines Corporation.

PlayStation is a registered trademark of Sony Computer Entertainment Inc.

PSP and PS3 are trademarks of Sony Computer Entertainment Inc.

RealPlayer is a registered trademark of RealNetworks, Inc.

TouchWare is a trademark of 3M Touch Systems, Inc.

Windows, Windows Media, Windows Vista, SQL Server, Xbox 360, and Internet Explorer are registered trademarks of Microsoft Corporation in the United States and other countries.

YouTube is a registered trademark of Google Inc.

Firefox is a registered trademark of the Mozilla Foundation.

Kensington and MicroSaver are registered trademarks of ACCO Brands Corporation.

The SuperSpeed USB Trident logo is a registered trademark of USB Implementers Forum, Inc.



EIZO, the EIZO Logo, ColorEdge, DuraVision, FlexScan, FORIS, RadiCS, RadiForce, RadiNET, Raptor, and ScreenManager are registered trademarks of EIZO Corporation in Japan and other countries.

ColorNavigator, EcoView NET, EIZO EasyPIX, EIZO Monitor Configurator, EIZO ScreenSlicer, G-Ignition, i•Sound, Re/Vue, Screen Administrator, and UniColor Pro are trademarks of EIZO Corporation.

All other company and product names are trademarks or registered trademarks of their respective owners.

## License / Copyright

A round gothic bold bit map font designed by Ricoh is used for the characters displayed on this product.

# FCC Declaration of Conformity

For U.S.A. , Canada, etc. (rated 100-120 Vac) Only

## FCC Declaration of Conformity

**We, the Responsible Party**

EIZO Inc.

5710 Warland Drive, Cypress, CA 90630

Phone: (562) 431-5011

**declare that the product**

Trade name: EIZO

Model: FORIS FS2434

**is in conformity with Part 15 of the FCC Rules. Operation of this product is subject to the following two conditions: (1) this device may not cause harmful interference, and (2) this device must accept any interference received, including interference that may cause undesired operation.**

This equipment has been tested and found to comply with the limits for a Class B digital device, pursuant to Part 15 of the FCC Rules. These limits are designed to provide reasonable protection against harmful interference in a residential installation. This equipment generates, uses, and can radiate radio frequency energy and, if not installed and used in accordance with the instructions, may cause harmful interference to radio communications. However, there is no guarantee that interference will not occur in a particular installation. If this equipment does cause harmful interference to radio or television reception, which can be determined by turning the equipment off and on, the user is encouraged to try to correct the interference by one or more of the following measures.

- \* Reorient or relocate the receiving antenna.
- \* Increase the separation between the equipment and receiver.
- \* Connect the equipment into an outlet on a circuit different from that to which the receiver is connected.
- \* Consult the dealer or an experienced radio/TV technician for help.

Changes or modifications not expressly approved by the party responsible for compliance could void the user's authority to operate the equipment.

### Note

Use the attached specified cable below or EIZO signal cable with this monitor so as to keep interference within the limits of a Class B digital device.

- AC Cord
- Shielded Signal Cable (Enclosed)

## Canadian Notice

This Class B digital apparatus complies with Canadian ICES-003.

Cet appareil numérique de la classe B est conforme à la norme NMB-003 du Canada.

## Hinweise zur Auswahl des richtigen Schwenkarms für Ihren Monitor

Dieser Monitor ist für Bildschirmarbeitsplätze vorgesehen. Wenn nicht der zum Standardzubehör gehörige Schwenkarm verwendet wird, muss statt dessen ein geeigneter anderer Schwenkarm installiert werden. Bei der

Auswahl des Schwenkarms sind die nachstehenden Hinweise zu berücksichtigen:

Der Standfuß muß den nachfolgenden Anforderungen entsprechen:

- a) Der Standfuß muß eine ausreichende mechanische Stabilität zur Aufnahme des Gewichtes vom Bildschirmgerät und des spezifizierten Zubehörs besitzen. Das Gewicht des Bildschirmgerätes und des Zubehörs sind in der zugehörigen Bedienungsanleitung angegeben.
- b) Die Befestigung des Standfußes muß derart erfolgen, daß die oberste Zeile der Bildschirmanzeige nicht höher als die Augenhöhe eines Benutzers in sitzender Position ist.
- c) Im Fall eines stehenden Benutzers muß die Befestigung des Bildschirmgerätes derart erfolgen, daß die Höhe der Bildschirmmitte über dem Boden zwischen 135 – 150 cm beträgt.
- d) Der Standfuß muß die Möglichkeit zur Neigung des Bildschirmgerätes besitzen (max. vorwärts: 5°, min. nach hinten  $\geq 5^\circ$ ).
- e) Der Standfuß muß die Möglichkeit zur Drehung des Bildschirmgerätes besitzen (max.  $\pm 180^\circ$ ). Der maximale Kraftaufwand dafür muß weniger als 100 N betragen.
- f) Der Standfuß muß in der Stellung verharren, in die er manuell bewegt wurde.
- g) Der Glanzgrad des Standfußes muß weniger als 20 Glanzeinheiten betragen (seidenmatt).
- h) Der Standfuß mit Bildschirmgerät muß bei einer Neigung von bis zu 10° aus der normalen aufrechten Position kippsicher sein.

## Hinweis zur Ergonomie :

Dieser Monitor erfüllt die Anforderungen an die Ergonomie nach EK1-ITB2000 mit dem Videosignal, 1920 × 1080, Digital Eingang und mindestens 60,0 Hz Bildwiederholfrequenz, non interlaced. Weiterhin wird aus ergonomischen Gründen empfohlen, die Grundfarbe Blau nicht auf dunklem Untergrund zu verwenden (schlechte Erkennbarkeit, Augenbelastung bei zu geringem Zeichenkontrast.)

Übermäßiger Schalldruck von Ohrhörern bzw. Kopfhörern kann einen Hörverlust bewirken. Eine Einstellung des Equalizers auf Maximalwerte erhöht die Ausgangsspannung am Ohrhörer- bzw. Kopfhörerausgang und damit auch den Schalldruckpegel.

„Maschinenlärminformations-Verordnung 3. GPSGV:

Der höchste Schalldruckpegel beträgt 70 dB(A) oder weniger gemäss EN ISO 7779“

[Begrenzung des maximalen Schalldruckpegels am Ohr]  
Bildschirmgeräte: Größte Ausgangsspannung 150 mV



# LIMITED WARRANTY

## LIMITED WARRANTY

EIZO Corporation (hereinafter referred to as “**EIZO**”) and distributors authorized by EIZO (hereinafter referred to as the “**Distributors**”) warrant, subject to and in accordance with the terms of this limited warranty (hereinafter referred to as the “**Warranty**”), to the original purchaser (hereinafter referred to as the “**Original Purchaser**”) who purchased the product specified in this document (hereinafter referred to as the “**Product**”) from EIZO or Distributors, that EIZO and Distributors shall, at their sole discretion, either repair or replace the Product at no charge if the Original Purchaser becomes aware within the Warranty Period (defined below) that the Product malfunctions or is damaged in the course of normal use of the Product in accordance with the description in the instruction manual attached to the Product (hereinafter referred to as the “**User’s Manual**”).

The period of this Warranty is limited to (i) five (5) years from the date of purchase of the Product; or, limited to the expiration of (ii) 30,000 hours of its use of the Product (hereinafter referred to as the “**Warranty Period**”). EIZO and Distributors shall bear no liability or obligation with regard to the Product in relation to the Original Purchaser or any third parties other than as provided under this Warranty.

EIZO and Distributors will cease to hold or store any parts (excluding design parts) of the Product upon expiration of seven (7) years after the production of such parts is discontinued. In repairing the monitor, EIZO and Distributors will use renewal parts which comply with our QC standards. If the unit cannot be repaired due to its condition or the stockout of a relevant part, EIZO and Distributors may offer the replacement by a product with equivalent performance instead of repairing it. The Warranty is valid only in the countries or territories where the Distributors are located. The Warranty does not restrict any legal rights of the Original Purchaser.

Notwithstanding any other provision of this Warranty, EIZO and Distributors shall have no obligation under this Warranty whatsoever in any of the cases as set forth below:

- (a) Any defect of the Product caused by freight damage, modification, alteration, abuse, misuse, accident, incorrect installation, disaster, faulty maintenance and/or improper repair by third party other than EIZO and Distributors;
- (b) Any incompatibility of the Product due to possible technical innovations and/or regulations;
- (c) Any deterioration of the sensor;
- (d) Any deterioration of display performance caused by the deterioration of expendable parts such as the LCD panel and/or backlight, etc. (e.g. changes in brightness, changes in brightness uniformity, changes in color, changes in color uniformity, defects in pixels including burnt pixels, etc.);
- (e) Any defect of the Product caused by external equipment;
- (f) Any defect of the Product on which the original serial number has been altered or removed;
- (g) Any defect of the Product caused by liquid leaking from battery;
- (h) Any normal deterioration of the product, particularly that of consumables, accessories, and/or attachments (e.g. batteries, buttons, rotating parts, remote control, cables, User’s Manual, etc.); and
- (i) Any deformation, discoloration, and/or warp of the exterior of the product including that of the surface of the LCD panel.

To obtain service under the Warranty, the Original Purchaser must deliver the Product, freight prepaid, in its original package or other adequate package affording an equal degree of protection, assuming the risk of damage and/or loss in transit, to the local Distributor. The Original Purchaser must present proof of purchase of the Product and the date of such purchase when requesting services under the Warranty.

The Warranty Period for any replaced and/or repaired product under this Warranty shall expire at the end of the original Warranty Period.

EIZO OR DISTRIBUTORS ARE NOT RESPONSIBLE FOR ANY DAMAGE TO, OR LOSS OF, DATA OR OTHER INFORMATION STORED IN ANY MEDIA OR ANY PART OF ANY PRODUCT RETURNED TO EIZO OR DISTRIBUTORS FOR REPAIR.

EIZO AND DISTRIBUTORS MAKE NO FURTHER WARRANTIES, EXPRESSED OR IMPLIED, WITH RESPECT TO THE PRODUCT AND ITS QUALITY, PERFORMANCE, MERCHANTABILITY OR FITNESS FOR ANY PARTICULAR USE. IN NO EVENT SHALL EIZO OR DISTRIBUTORS BE LIABLE FOR ANY INCIDENTAL, INDIRECT, SPECIAL, CONSEQUENTIAL OR OTHER DAMAGE WHATSOEVER (INCLUDING, WITHOUT LIMITATION, DAMAGES FOR LOSS OF PROFIT, BUSINESS INTERRUPTION, LOSS OF BUSINESS INFORMATION, OR ANY OTHER PECUNIARY LOSS) ARISING OUT OF THE USE OR INABILITY TO USE THE PRODUCT OR IN ANY CONNECTION WITH THE PRODUCT, WHETHER BASED ON CONTRACT, TORT, NEGLIGENCE, STRICT LIABILITY OR OTHERWISE, EVEN IF EIZO OR DISTRIBUTORS HAVE BEEN ADVISED OF THE POSSIBILITY OF SUCH DAMAGES. THIS EXCLUSION ALSO INCLUDES ANY LIABILITY WHICH MAY ARISE OUT OF THIRD PARTY CLAIMS AGAINST THE ORIGINAL PURCHASER. THE ESSENCE OF THIS PROVISION IS TO LIMIT THE POTENTIAL LIABILITY OF EIZO AND DISTRIBUTORS ARISING OUT OF THIS LIMITED WARRANTY AND/OR SALES.

## BEGRENZTE GARANTIE

EIZO Corporation (im Weiteren als „**EIZO**“ bezeichnet) und die Vertragsimporteure von EIZO (im Weiteren als „**Vertrieb(e)**“ bezeichnet) garantieren dem ursprünglichen Käufer (im Weiteren als „**Erstkäufer**“ bezeichnet), der das in diesem Dokument vorgegebene Produkt (im Weiteren als „**Produkt**“ bezeichnet) von EIZO oder einem Vertrieb erworben hat, gemäß den Bedingungen dieser beschränkten Garantie (im Weiteren als „**Garantie**“ bezeichnet), dass EIZO und der Vertrieb nach eigenem Ermessen das Produkt entweder kostenlos reparieren oder austauschen, falls der Erstkäufer innerhalb der Garantiefrist (weiter unten festgelegt) eine Fehlfunktion bzw. Beschädigung des Produkts feststellt, die während des normalen Gebrauchs des Produkts gemäß den Anweisungen des zum Lieferumfang des Produkts gehörenden Benutzerhandbuchs (im Weiteren als „**Benutzerhandbuch**“ bezeichnet) aufgetreten ist.

Die Dauer der Garantieleistung beträgt (i) fünf (5) Jahre ab dem Erstverkaufsdatum des Produkts oder (ii) 30.000 Betriebsstunden des Produkts (im Weiteren als „**Garantiefrist**“ bezeichnet). EIZO und die Vertriebe übernehmen über den Rahmen dieser Garantie hinaus hinsichtlich des Produkts keinerlei Haftung oder Verpflichtung dem Erstkäufer oder Dritten gegenüber.

Nach Ablauf von sieben (7) Jahren nach Ende der Produktion solcher Teile werden EIZO und Vertriebshändler keine Teile (mit Ausnahme von Konstruktionsteilen) mehr vorhalten und lagern. EIZO und seine Vertriebspartner verpflichten sich, bei einer etwaigen Reparatur des Monitors ausschließlich Produkte gemäß den EIZO-Qualitätssicherungsstandards zu verwenden. Wenn das Gerät aufgrund seines Zustands oder eines Fehlbestands bei einem entsprechenden Teil nicht repariert werden kann, können EIZO und Vertriebshändler statt der Reparatur des Geräts den Austausch gegen ein Produkt mit gleichwertiger Leistung anbieten.

Diese Garantie gilt nur in Ländern oder Gebieten, in denen sich Vertriebe befinden. Die gesetzlichen Gewährleistungsrechte des Erstkäufers gegenüber dem Verkäufer werden durch diese Garantie nicht berührt.

EIZO und die Vertriebe besitzen im Rahmen dieser Garantie keinerlei Verpflichtung in den folgenden Fällen:

- (a) Produktdefekte, die auf Frachtschäden, Modifikation, Nachgestaltung, Missbrauch, Fehlbedienung, Unfälle, unsachgemäße Installation, Naturkatastrophen, fehlerhafte Wartung und/oder unsachgemäße Reparatur durch eine andere Partei als EIZO und die Vertriebe zurückzuführen sind.
- (b) Eine Inkompatibilität des Produkts aufgrund von technischen Neuerungen und/oder neuen Bestimmungen, die nach dem Kauf in Kraft treten.
- (c) Jegliche Verschlechterung des Sensors.
- (d) Jegliche Verschlechterung der Bildschirmleistung, die durch Verschleißteile wie das LCD-Panel und/oder die Hintergrundbeleuchtung usw. hervorgerufen werden (z.B. Veränderungen von Helligkeit oder Helligkeitsverteilung, Veränderungen von Farbe oder Farbverteilung, Pixeldefekte einschließlich von durchgebrannten Pixeln usw.).
- (e) Produktdefekte, die durch externe Geräte verursacht werden.
- (f) Jeglicher Defekt eines Produkts, dessen ursprüngliche Seriennummer geändert oder entfernt wurde.
- (g) Produktdefekte, die durch Austritt von Batterieflüssigkeit verursacht werden.
- (h) Normale Abnutzung des Produkts, insbesondere von Verbrauchsteilen, Zubehörteilen und/oder Beilagen (z.B. Batterien, Tasten, drehbare Teile, Fernbedienung, Kabel, Benutzerhandbuch usw.); sowie
- (i) Verformungen, Verfärbungen und/oder Verziehungen am Produktäußeren, einschließlich der Oberfläche des LCD-Panels.

Bei Inanspruchnahme der Garantieleistung ist der Erstkäufer verpflichtet, das Produkt auf eigene Kosten und in der Originalverpackung bzw. einer anderen geeigneten Verpackung, die einen gleichwertigen Schutz gegen Transportschäden bietet, an den örtlichen Vertrieb zu übersenden, wobei der Erstkäufer das Transportrisiko gegenüber Schäden und/oder Verlust trägt. Zum Zeitpunkt der Inanspruchnahme der Garantieleistung muss der Erstkäufer einen Verkaufsbeleg vorweisen, auf dem das Kaufdatum angegeben ist.

Die Garantiefrist für ein im Rahmen dieser Garantie ausgetauschtes und/oder repariertes Produkt erlischt nach Ablauf der ursprünglichen Garantiefrist.

EIZO ODER DIE EIZO-VERTRAGSIMPORTEURE HAFTEN NICHT FÜR ZERSTÖRTE DATENBESTÄNDE ODER DIE KOSTEN DER WIEDERBESCHAFFUNG DIESER DATENBESTÄNDE AUF JEDLICHEN DATENTRÄGERN ODER TEILEN DES PRODUKTS, DIE IM RAHMEN DER GARANTIE BEI EIZO ODER DEN EIZO-VERTRAGSIMPORTEUREN ZUR REPARATUR EINGEREICHT WURDEN.

EIZO UND DIE EIZO-VERTRAGSIMPORTEURE GEBEN WEDER EXPLIZITE NOCH IMPLIZITE GARANTIEEN IN BEZUG AUF DIESES PRODUKT UND SEINE QUALITÄT, LEISTUNG, VERKÄUFLICHKEIT ODER EIGNUNG FÜR EINEN BESTIMMTEN ZWECK. AUF KEINEN FALL SIND EIZO ODER DIE EIZO-VERTRAGSIMPORTEURE VERANTWORTLICH FÜR JEDLICHE ZUFÄLLIGE, INDIREKTE, SPEZIELLE, FOLGE- ODER ANDERE SCHÄDEN JEDLICHER ART (EINSCHLIESSLICH OHNE JEDE BEGRENZUNG SCHÄDEN BEZÜGLICH PROFITVERLUST, GESCHÄFTSUNTERBRECHUNG, VERLUST VON GESCHÄFTSINFORMATION ODER JEDLICHE ANDEREN FINANZIELLEN EINBUSSEN), DIE DURCH DIE VERWENDUNG DES PRODUKTES ODER DIE UNFÄHIGKEIT ZUR VERWENDUNG DES PRODUKTES ODER IN JEDLICHER BEZIEHUNG MIT DEM PRODUKT, SEI ES BASIEREND AUF VERTRAG, SCHADENSERSATZ, NACHLAESSIGKEIT, STRIKTE HAFTPFLICHT ODER ANDEREN FORDERUNGEN ENTSTEHEN, AUCH WENN EIZO UND DIE EIZO-VERTRAGSIMPORTEURE IM VORAUS ÜBER DIE MÖGLICHKEIT SOLCHER SCHÄDEN INFORMIERT WURDEN. DIESER AUSSCHLUSS ENTHÄLT AUCH JEDE HAFTPFLICHT, DIE AUS FORDERUNGEN DRITTER GEGEN DEN ERSTKÄUFER ENTSTEHEN KANN. ZWECK DIESER KLAUSEL IST ES, DIE HAFTUNG VON EIZO UND DEN VERTRIEBEN GEGENÜBER FORDERUNGEN ZU BEGRENZEN, DIE AUS DIESER BESCHRÄNKTEN GARANTIE UND/ODER DEM VERKAUF ENTSTEHEN KÖNNEN.

## GARANTIE LIMITÉE

EIZO Corporation (ci-après dénommé « **EIZO** ») et les distributeurs autorisés par EIZO (ci-après dénommés « **Distributeurs** »), sous réserve et conformément aux termes de cette garantie limitée (ci-après dénommée « **Garantie** »), garantissent à l'acheteur initial (ci-après dénommé « **Acheteur initial** ») du produit spécifié dans la présente (ci-après dénommé « **Produit** ») acheté auprès d'EIZO ou de Distributeurs agréés EIZO, que EIZO et ses Distributeurs auront pour option de réparer ou remplacer gratuitement le Produit si l'Acheteur initial constate, pendant la Période de garantie (définie ci-dessous), qu'il y a un dysfonctionnement ou que le Produit a subi un dommage dans le cadre d'une utilisation normale du Produit conformément à la description du mode d'emploi qui accompagne le Produit (ci-après dénommé « **Manuel d'utilisation** »).

La période de cette Garantie est limitée à (i) cinq (5) ans à partir de la date d'achat du Produit ; ou, limitée jusqu'à l'expiration de (ii) 30 000 heures d'utilisation du Produit (ci-après dénommée « **Période de Garantie** »). EIZO et ses Distributeurs déclinent toute responsabilité ou obligation concernant ce Produit face à l'Acheteur initial ou à toute autre personne à l'exception de celles stipulées dans la présente Garantie.

EIZO et ses Distributeurs cesseront de conserver ou de stocker des pièces (à l'exception des pièces de conception) du Produit à l'expiration d'une période de sept (7) ans après l'arrêt de la production de ces pièces. Pour réparer le moniteur, EIZO et ses distributeurs utiliseront des pièces de rechange conformes à nos normes de contrôle qualité. Si l'unité ne peut pas être réparée en raison de son état ou de la rupture de stock d'une pièce adéquate, EIZO et ses Distributeurs peuvent proposer le remplacement par un produit aux performances équivalentes au lieu de le réparer.

La Garantie est valable uniquement dans les pays ou les territoires où se trouvent les Distributeurs. La Garantie ne limite aucun des droits reconnus par la loi à l'Acheteur initial.

Nonobstant toute autre clause de cette Garantie, EIZO et ses Distributeurs n'auront d'obligation dans le cadre de cette Garantie pour aucun des cas énumérés ci-dessous :

- (a) Tout défaut du Produit résultant de dommages occasionnés lors du transport, d'une modification, d'une altération, d'un abus, d'une mauvaise utilisation, d'un accident, d'une installation incorrecte, d'un désastre, d'un entretien et/ou d'une réparation incorrects effectués par une personne autre que EIZO ou ses Distributeurs ;
- (b) Toute incompatibilité du Produit résultant d'améliorations techniques et/ou réglementations possibles ;
- (c) Toute détérioration du capteur ;
- (d) Toute détérioration des performances d'affichage causée par la détérioration des éléments consommables tels que le panneau LCD et/ou le rétroéclairage, etc. (par exemple des changements de luminosité, des changements de l'uniformité de la luminosité, des modifications de couleur, des changements de l'uniformité des couleurs, des défauts de pixels y compris des pixels brûlés, etc.);
- (e) Tout défaut du Produit causé par un appareil externe ;
- (f) Tout défaut d'un Produit sur lequel le numéro de série original a été altéré ou supprimé ;
- (g) Tout défaut du Produit causé par un écoulement du liquide contenu dans les piles ;
- (h) Toute détérioration normale du Produit, particulièrement celle des consommables, des accessoires et/ou des pièces reliées au Produit (piles, touches, éléments pivotants, télécommande, câbles, Manuel d'utilisation etc.), et
- (i) Toute déformation, décoloration, et/ou gondolage de l'extérieur du Produit, y compris celle de la surface du panneau LCD.

Pour bénéficier d'un service dans le cadre de cette Garantie, l'Acheteur initial doit renvoyer le Produit port payé, dans son emballage d'origine ou tout autre emballage approprié offrant un degré de protection équivalent, au Distributeur local, et assumera la responsabilité des dommages et/ou perte possibles lors du transport. L'Acheteur initial doit présenter une preuve d'achat du Produit comprenant sa date d'achat pour bénéficier de ce service dans le cadre de la Garantie.

La Période de garantie pour tout Produit remplacé et/ou réparé dans le cadre de cette Garantie expirera à la fin de la Période de garantie initiale.

**EIZO OU SES DISTRIBUTEURS NE SAURAIENT ÊTRE TENUS RESPONSABLES DES DOMMAGES OU PERTES DE DONNÉES OU D'AUTRES INFORMATIONS STOCKÉES DANS UN MÉDIA QUELCONQUE OU UNE AUTRE PARTIE DU PRODUIT RENVOYÉ À EIZO OU AUX DISTRIBUTEURS POUR RÉPARATION.**

AUCUNE AUTRE GARANTIE, EXPLICITE OU TACITE, N'EST OFFERTE PAR EIZO ET SES DISTRIBUTEURS CONCERNANT LE PRODUIT ET SES QUALITÉS, PERFORMANCES, QUALITÉ MARCHANDE OU ADAPTATION À UN USAGE PARTICULIER. EN AUCUN CAS, EIZO OU SES DISTRIBUTEURS NE SERONT RESPONSABLES DES DOMMAGES FORTUITS, INDIRECTS, SPÉCIAUX, INDUITS, OU DE TOUT AUTRE DOMMAGE QUEL QU'IL SOIT (Y COMPRIS, SANS LIMITATION, LES DOMMAGES RÉSULTANT D'UNE PERTE DE PROFIT, D'UNE INTERRUPTION D'ACTIVITÉS, D'UNE PERTE DE DONNÉES COMMERCIALES, OU DE TOUT AUTRE MANQUE À GAGNER) RÉSULTANT DE L'UTILISATION OU DE L'INCAPACITÉ D'UTILISER LE PRODUIT OU AYANT UN RAPPORT QUELCONQUE AVEC LE PRODUIT, QUE CE SOIT SUR LA BASE D'UN CONTRAT, D'UN TORT, D'UNE NÉGLIGENCE, D'UNE RESPONSABILITÉ STRICTE OU AUTRE, MÊME SI EIZO OU SES DISTRIBUTEURS ONT ÉTÉ AVERTIS DE LA POSSIBILITÉ DE TELS DOMMAGES. CETTE LIMITATION INCLUT AUSSI TOUTE RESPONSABILITÉ QUI POURRAIT ÊTRE SOULEVÉE LORS DES RÉCLAMATIONS D'UN TIERS CONTRE L'ACHETEUR INITIAL. L'ESSENCE DE CETTE CLAUSE EST DE LIMITER LA RESPONSABILITÉ POTENTIELLE DE EIZO ET DE SES DISTRIBUTEURS RÉSULTANT DE CETTE GARANTIE LIMITÉE ET/OU DES VENTES.

## GARANTÍA LIMITADA

EIZO Corporation (en lo sucesivo “EIZO”) y sus distribuidores autorizados (en lo sucesivo los “Distribuidores”), con arreglo y de conformidad con los términos de esta garantía limitada (en lo sucesivo la “Garantía”), garantizan al comprador original (en lo sucesivo el “Comprador original”) que compró el producto especificado en este documento (en lo sucesivo el “Producto”) a EIZO o a sus Distribuidores, que EIZO y sus Distribuidores, a su propio criterio, repararán o sustituirán el Producto de forma gratuita si el Comprador original detecta dentro del periodo de la Garantía (indicado posteriormente) que el Producto no funciona correctamente o que se ha averiado durante el uso normal del mismo de acuerdo con las indicaciones del manual de instrucciones suministrado con el Producto (en lo sucesivo el “Manual del usuario”).

El periodo de validez de esta Garantía está limitado a (i) cinco (5) años a partir de la fecha de compra del Producto o (ii) a 30.000 horas de uso del Producto (en adelante designado como el “Periodo de Garantía”). EIZO y sus Distribuidores no tendrán ninguna responsabilidad ni obligación con respecto al Producto para con el Comprador original ni con terceros que no sean las estipuladas en la presente Garantía.

EIZO y sus distribuidores dejarán de tener o almacenar cualquier pieza del producto (excepto piezas del diseño) una vez expirado el periodo de siete (7) años después de que hayan dejado de fabricarse tales piezas. Para la reparación del monitor, EIZO y los distribuidores utilizarán repuestos que cumplan con nuestros estándares de control de calidad. Si no se puede reparar la unidad debido a su estado o si se han agotado las existencias de una pieza importante, EIZO y sus distribuidores podrán ofrecerle sustituirlo por un producto con rendimiento equivalente en lugar de repararlo.

La Garantía es válida sólo en los países y territorios donde están ubicados los Distribuidores. La Garantía no restringe ningún derecho legal del Comprador original.

A pesar de las estipulaciones de esta Garantía, EIZO y sus Distribuidores no tendrán obligación alguna bajo esta Garantía en ninguno de los casos expuestos a continuación:

- (a) Cualquier defecto del Producto causado por daños en el transporte, modificación, alteración, abuso, uso incorrecto, accidente, instalación incorrecta, desastre, mantenimiento incorrecto y/o reparación indebida realizada por un tercero que no sea EIZO o sus Distribuidores.
- (b) Cualquier incompatibilidad del Producto debida a posibles innovaciones técnicas y/o reglamentaciones.
- (c) Cualquier deterioro del sensor.
- (d) Cualquier deterioro en el rendimiento de la visualización causado por fallos en las piezas consumibles como el panel LCD y/o la "Backlight", etc. (p. ej. cambios de brillo, cambios de uniformidad del brillo, cambios de color, cambios de uniformidad del color, defectos de píxeles, incluyendo píxeles muertos, etc.).
- (e) Cualquier defecto del Producto causado por un equipo externo.
- (f) Cualquier defecto del Producto en el que haya sido alterado o borrado el número de serie original.
- (g) Cualquier defecto del Producto causado por fugas de líquido de las pilas.
- (h) Cualquier deterioro normal del Producto, y en particular de las piezas consumibles, accesorios y demás (p. ej. pilas, botones, piezas giratorias, mando a distancia, cables, Manual del usuario, etc.).
- (i) Cualquier deformación, decoloración y/o alabeo del exterior del Producto incluida la superficie del panel LCD.

Para obtener servicio en los términos de esta Garantía, el Producto deberá ser enviado por el Comprador original, a su Distribuidor local, con el transporte previamente pagado, en el embalaje original u otro embalaje adecuado que ofrezca el mismo grado de protección, asumiendo el riesgo de daños y/o pérdida del Producto durante el transporte. El Comprador original deberá presentar un comprobante de compra del Producto en el que se refleje la fecha de compra del mismo cuando lo solicite el servicio de Garantía.

El Periodo de garantía para cualquier Producto reemplazado y/o reparado en los términos de esta Garantía expirará al vencer el Periodo de garantía original.

EIZO O LOS DISTRIBUIDORES AUTORIZADOS DE EIZO NO SE RESPONSABILIZAN DE NINGÚN DAÑO O PÉRDIDA QUE PUEDAN SUFRIR LOS DATOS U OTRA INFORMACIÓN ALMACENADA EN CUALQUIER MEDIO O CUALQUIER PARTE DE CUALQUIER PRODUCTO DEVUELTO A EIZO O A LOS DISTRIBUIDORES DE EIZO PARA SU REPARACIÓN.

EIZO Y LOS DISTRIBUIDORES AUTORIZADOS DE EIZO NO OFRECEN NINGUNA OTRA GARANTÍA, IMPLÍCITA NI EXPLÍCITA, CON RESPECTO AL PRODUCTO Y A SU CALIDAD, RENDIMIENTO, COMERCIABILIDAD E IDONEIDAD PARA CUALQUIER USO EN PARTICULAR. EN NINGÚN CASO SERÁN EIZO O LOS DISTRIBUIDORES AUTORIZADOS DE EIZO RESPONSABLES DE NINGÚN DAÑO EMERGENTE, INDIRECTO, ESPECIAL, INHERENTE O CUALQUIERA QUE SEA (INCLUYENDO, SIN LIMITACIÓN, DAÑOS POR LUCRO CESANTE, INTERRUPCIÓN DE LA ACTIVIDAD COMERCIAL, PÉRDIDA DE INFORMACIÓN COMERCIAL O CUALQUIER OTRA PÉRDIDA PECUNIARIA) QUE SE DERIVE DEL USO O IMPOSIBILIDAD DE USO DEL PRODUCTO O EN RELACIÓN CON EL PRODUCTO, YA SEA BASADO EN CONTRATO, POR AGRAVIO, NEGLIGENCIA, ERICTA RESPONSABILIDAD O CUALQUIERA QUE SEA, AUN CUANDO SE HAYA ADVERTIDO A EIZO O A LOS DISTRIBUIDORES DE EIZO DE LA POSIBILIDAD DE TALES DAÑOS. ESTA EXCLUSIÓN TAMBIÉN ABARCA CUALQUIER RESPONSABILIDAD QUE PUEDA DERIVARSE DE RECLAMACIONES HECHAS POR UN TERCERO CONTRA EL COMPRADOR ORIGINAL. LA ESENCIA DE ESTA ESTIPULACIÓN ES LIMITAR LA RESPONSABILIDAD POTENCIAL DE EIZO Y LOS DISTRIBUIDORES QUE PUDIERA DERIVARSE DE ESTA GARANTÍA LIMITADA Y/O VENTAS.

## GARANZIA LIMITATA

EIZO Corporation (a cui si farà riferimento da qui in poi con “**EIZO**”) ed i Distributori autorizzati da EIZO (a cui si farà riferimento da qui in poi con “**Distributori**”) garantiscono, secondo i termini di questa garanzia limitata (a cui si farà riferimento da qui in poi con “**Garanzia**”) all’acquirente originale (a cui si farà riferimento da qui in poi con “**Acquirente originale**”) che ha acquistato il prodotto specificato in questo documento (a cui si farà riferimento da qui in poi con “**Prodotto**”) da EIZO o dai suoi Distributori, che EIZO e i distributori, a loro discrezione, ripareranno o sostituiranno il Prodotto senza addebito se l’Acquirente originale trova, entro il periodo della Garanzia (definito sotto), che il Prodotto malfunziona e si è danneggiato nel corso del suo normale utilizzo osservando le indicazioni del manuale di istruzioni allegato al Prodotto (a cui si farà riferimento da qui in poi con “**Manuale utente**”).

La presente Garanzia è limitata a (i) cinque (5) anni a partire dalla data d’acquisto del Prodotto o (ii) allo scadere di 30.000 ore d’utilizzo del Prodotto (a cui si farà riferimento da qui in poi con “**Periodo di Garanzia**”). EIZO e i suoi Distributori non si assumono alcuna responsabilità e non hanno alcun obbligo riguardo al Prodotto verso l’Acquirente originale o terzi diversi da quelli relativi a questa Garanzia.

EIZO e i distributori cesseranno lo stoccaggio dei componenti (tranne le parti relative al progetto) del prodotto dopo sette (7) anni dall’interruzione della produzione di tali componenti. Per la riparazione del monitor, EIZO e i Distributori utilizzeranno parti di ricambio conformi ai nostri standard di controllo della qualità. Se l’unità non può essere riparata a causa delle sue condizioni o dell’esaurimento scorte di un componente rilevante, EIZO e i distributori potrebbero offrire la sostituzione con un prodotto con prestazioni equivalenti piuttosto ripararlo.

La Garanzia è valida soltanto nei paesi dove ci sono i Distributori EIZO. La Garanzia non limita alcun diritto legale dell’Acquirente originale.

Indipendentemente da qualsiasi altra condizione di questa Garanzia, EIZO e i suoi Distributori non avranno alcun obbligo derivante da questa Garanzia in ognuno dei casi elencati di seguito:

- (a) Qualsiasi difetto del Prodotto causato da danni di trasporto, modifiche, alterazioni, abusi, usi impropri, incidenti, installazione errata, calamità, manutenzione errata e/o riparazioni improprie eseguite da terze parti che non siano EIZO o i suoi Distributori.
- (b) Qualsiasi incompatibilità del Prodotto dovuta a possibili innovazioni tecniche e/o normative.
- (c) Qualsiasi deterioramento del sensore.
- (d) Qualsiasi deterioramento delle prestazioni dello schermo causato dal deterioramento delle parti consumabili, come il pannello LCD e/o la retroilluminazione, ecc. (per esempio: i cambiamenti di luminosità, cambiamenti di uniformità della luminosità, i cambiamenti di colore, i cambiamenti di uniformità del colore, i difetti dei pixel, inclusi i pixel bruciati, ecc.).
- (e) Qualsiasi difetto del Prodotto causato da apparecchiature esterne.
- (f) Qualsiasi difetto del Prodotto in cui il numero di serie originale sia stato alterato o rimosso.
- (g) Qualsiasi difetto del Prodotto causato dalla fuoriuscita di liquido dalle pile.
- (h) Qualsiasi normale deterioramento del Prodotto, in particolar modo nelle sue parti di consumo, accessori, e/o attacchi (per esempio: pile, tasti, parti rotanti, telecomando, cavi, Manuale dell’utente, ecc.).
- (i) Qualsiasi tipo di deformazione, scolorimento, e/o di involucro esterno del Prodotto inclusa la superficie del pannello LCD.

Per ricevere assistenza tecnica con questa Garanzia, l’Acquirente originale deve inviare il Prodotto, con trasporto pre-pagato, nella sua confezione originale o altra confezione adeguata che fornisce un livello analogo di protezione, assumendosi il rischio di danni e/o perdita in transito, al Distributore locale. L’Acquirente originale deve presentare la prova di acquisto che stabilisce la data di acquisto del Prodotto quando richiede servizio sotto Garanzia.

Il Periodo di garanzia per qualsiasi Prodotto sostituito e/o riparato sotto questa Garanzia scade alla fine del Periodo di garanzia originale.

EIZO O I SUOI DISTRIBUTORI NON SONO RESPONSABILI PER QUALSIASI DANNO O PERDITA DI DATI O ALTRE INFORMAZIONI MEMORIZZATI SU QUALSIASI SUPPORTO O QUALSIASI PARTE DI QUALSIASI PRODOTTO INVIATO A EIZO O I SUOI DISTRIBUTORI PER RIPARAZIONI.

EIZO E I SUOI DISTRIBUTORI NON OFFRONO ALCUNA GARANZIA ADDIZIONALE, IMPLICITA O ESPLICITA, RIGUARDO IL PRODOTTO E LA SUA QUALITÀ, PRESTAZIONI, VENDIBILITÀ O APPROPRIATEZZA PER QUALSIASI USO PARTICOLARE. IN NESSUN CASO EIZO O I DISTRIBUTORI EIZO AUTORIZZATI SARANNO RESPONSABILI PER QUALSIASI DANNO ACCIDENTALE, INDIRECTO, SPECIALE, CONSEGUENTE O DI QUALSIASI ALTRA NATURA (INCLUSI, SENZA LIMITI, DANNI PER PERDITA DI PROFITTI, INTERRUZIONE DELLE ATTIVITÀ, PERDITA DI INFORMAZIONI D’AFFARI O QUALSIASI ALTRA PERDITA PECUNIARIA) DERIVANTI DALL’USO O DALL’IMPOSSIBILITÀ DI USARE IL PRODOTTO O IN QUALSIASI RELAZIONE AL PRODOTTO, SIA SU BASE DI CONTRATTO, TORTO, NEGLIGENZA, STRETTA RESPONSABILITÀ O ALTRIMENTI, ANCHE SE EIZO O I DISTRIBUTORI EIZO AUTORIZZATI SONO STATI AVVERTITI DELLA POSSIBILITÀ DI TALI DANNI. QUESTA ESCLUSIONE INCLUDE ANCHE QUALSIASI RESPONSABILITÀ CHE POSSA INSORGERE DA RECLAMI DI TERZI CONTRO L’ACQUIRENTE ORIGINALE. L’ESSENZA DI QUESTO PROVVEDIMENTO È LIMITARE LA RESPONSABILITÀ POTENZIALE DI EIZO E DEI DISTRIBUTORI DERIVANTE DA QUESTA GARANZIA LIMITATA E/O DALLE VENDITE.



## BEGRÄNSAD GARANTI

EIZO Corporation (nedan kallat "**EIZO**") och EIZOs auktoriserade distributörer (nedan kallade "**Distributörer**") garanterar i enlighet med villkoren i denna begränsade garanti (nedan kallad "**Garantin**") den ursprunglige köparen (nedan kallad den "**Ursprunglige köparen**") som köpte den i dokumentet specificerade produkten (nedan kallad "**Produkten**") från EIZO eller Distributörer, att EIZO eller Distributörer enligt eget gottfinnande kostnadsfritt antingen reparera eller byta ut den defekta Produkten om den Ursprunglige köparen inom Garantiperioden (definieras nedan) upptäcker att Produkten fungerar felaktigt eller skadas under normal användning av Produkten i enlighet med beskrivningen i bruksanvisningen (nedan kallad "**Bruksanvisning**").

Giltighetsperioden för denna garanti är begränsad till (i) fem (5) år från datumet för Produktens inköp eller, om detta inträffar tidigare, begränsat till utlöpanget av (ii) 30 000 timmars användning av Produkten (häri kallad "**Garantiperioden**"). EIZO och Distributörer ska inte under några villkor ha något annat ansvar än vad som anges i denna garanti gällande Produkten i relation till den Ursprunglige köparen eller tredje part.

EIZO och dess leverantörer slutar lagerföra delar (utom designdelar) till produkten sju (7) år efter att delen i fråga slutar tillverkas. Nät skärmen repareras använder EIZO och distributörer reservdelar som uppfyller våra kvalitetsstandarder. Om enheten inte kan repareras på grund av skicket eller att en del inte finns i lager kan EIZO och dess leverantörer erbjuda sig att byta ut produkten mot en produkt med likvärdig prestanda istället för att reparera den.

Garantin är endast giltig i de länder där det finns Distributörer. Garantin begränsar inte några av den Ursprunglige köparens lagstadgade rättigheter.

Oavsett andra villkor i denna garanti ska inte EIZO Distributörer under några villkor ha något ansvar i något av de fall som beskrivs nedan:

- (a) När någon bristfällighet hos Produkten kan härledas till att ha uppstått vid frakt, modifiering, ändring, felaktigt handhavande, olycka, felaktig installation, katastrof, felaktigt underhåll och/eller felaktig reparation utförd av tredje part annan än EIZO och Distributörer.
- (b) Alla former av inkompatibilitet hos Produkten på grund av möjliga tekniska innovationer och/eller bestämmelser.
- (c) Alla försämringar av sensorn.
- (d) Alla försämringar av bildens prestanda beroende på förbrukningsdelar så som LCD-panel och/eller bakgrundsbelysning etc. (t.ex. ändringar i ljusstyrka, jämnhet i ljusstyrka, färg, färgjämnhet, defekta pixlar och/eller fast lysande pixlar etc.).
- (e) Alla defekter hos Produkten som orsakats av extern utrustning.
- (f) Alla defekter hos Produkten på vilken det ursprungliga serienumret har ändrats eller avlägsnats.
- (g) Alla produktfel som orsakas av vätska som läcker från batteriet.
- (h) All normal försämring av Produkten, speciellt förbrukningsartiklar, tillbehör och/eller yttre delar (t.ex. batterier, knappar, roterande delar, fjärrkontroll, kablar, Bruksanvisningen etc.).
- (i) Varje deformation, missfärgning och/eller skevhet av Produktens yttre inklusive ytan på LCD-panelen.

För att erhålla service under denna garanti måste den Ursprunglige köparen (med hänseende till risken för skada och/eller förlust under transport) leverera Produkten till närmaste Distributör med förebetalad frakt, i dess ursprungliga förpackning eller annan fullgod förpackning som ger likvärdigt skydd. Den Ursprunglige köparen måste kunna visa inköpsbevis för Produkten som klargör Produktens inköpsdatum vid begäran av garantiservice.

Garantiperioden för alla utbytta och/eller reparerade produkter under denna garanti skall upphöra vid utgången av den ursprungliga Garantiperioden.

**EIZO ELLER DISTRIBUTÖRER ÄR INTE ANSVARIGA FÖR NÅGON FORM AV SKADA ELLER FÖRLUST AV DATA ELLER ANNAN INFORMATION SOM HAR LAGRATS I NÅGON FORM AV MEDIA ELLER ANNAN DEL AV NÅGON PRODUKT SOM HAR RETURNERATS TILL EIZO ELLER DISTRIBUTÖRER FÖR REPARATION.**

**EIZO OCH DISTRIBUTÖRERNA GARANTERAR INGET, UTTRYCKLIGEN ELLER UNDERFÖRSTÅTT, VAD BETRÄFFAR PRODUKTEN OCH DESS KVALITET, PRESTANDA, SÄLJBARHET ELLER LÄMPLIGHET FÖR NÅGON FORM AV SPECIELL ANVÄNDNING. UNDER INGA OMSTÄNDIGHETER SKALL EIZO ELLER DISTRIBUTÖRERNA HÅLLAS ANSVARIGA FÖR NÅGRA SOM HELST UNDERORDNADE, INDIREKTA, SPECIELLA, DÄRAV FÖLJANDE ELLER ÖVRIGA SKADOR (INKLUSIVE, UTAN BEGRÄNSNING TILL, SKADOR FÖR FÖRLUST AV INKOMST, AVBRUTEN AFFÄRSRÖRELSE, FÖRLUST AV AFFÄRSINFORMATION ELLER ANNAN SÄRSKILD FÖRLUST) SOM UPPSTÅTT SOM ETT RESULTAT AV ANVÄNDNING ELLER OFÖRMÅGA ATT ANVÄNDA PRODUKTEN ELLER I NÅGON FORM AV ANSLUTNING TILL PRODUKTERNA, VARE SIG DETTA GRUNDAS PÅ KONTRAKT, ÅTALBAR HANDLING, FÖRSUMLIGHET, ANSVARSSKYLDIGHET ELLER ANNAT, ÄVEN OM EIZO ELLER DISTRIBUTÖRERNA HAR INFORMERATS BETRÄFFANDE MÖJLIGHET ATT SÅDANA SKADOR FÖRELIGGER. DETTA UNDANTAG OMFATTAR ÄVEN ALL FORM AV ANSVARSSKYLDIGHET SOM KAN UPPSTÅ GENOM EN TREDJE PARTS ANSPRÅK GENTEMOT DEN URSPRUNGLIGE KÖPAREN. GRUNDBESTÄNDSDELEN I BESTÄMMELEN ÄR ATT BEGRÄNSA DET EVENTUELLA ANSVARSTAGANDET FÖR EIZO OCH DISTRIBUTÖRERNA SOM KAN UPPSTÅ GENOM DENNA BEGRÄNSADE GARANTI OCH/ELLER FÖRSÄLJNING.**

## ΠΕΡΙΟΡΙΣΜΕΝΗ ΕΓΓΥΗΣΗ

Η EIZO Corporation (στο εξής «**EIZO**») και οι διανομείς που εξουσιοδοτεί η EIZO (στο εξής «**Διανομείς**») παρέχουν εγγύηση, υποκείμενη και σύμφωνα με τους όρους της παρούσας περιορισμένης εγγύησης (στο εξής «**Εγγύηση**»), στον αρχικό αγοραστή (στο εξής «**Αρχικός Αγοραστής**») ο οποίος αγόρασε το προϊόν που καθορίζεται στο παρόν έγγραφο (στο εξής «**Προϊόν**») από την EIZO ή τους Διανομείς, η οποία εξασφαλίζει ότι η EIZO και οι Διανομείς, σύμφωνα με τη διακριτή ευχέρειά τους, είτε θα επισκευάσουν είτε θα αντικαταστήσουν το Προϊόν χωρίς χρέωση εάν ο Αρχικός Αγοραστής αντιληφθεί εντός της Περιόδου Εγγύησης (ορίζεται κατωτέρω) ότι το Προϊόν δυσλειτουργεί ή έχει υποστεί βλάβη κατά τη διάρκεια κανονικής χρήσης του Προϊόντος σύμφωνα με την περιγραφή στο εγχειρίδιο χρήσης που συνοδεύει το Προϊόν (στο εξής «**Εγχειρίδιο Χρήστη**»).

Η περίοδος της παρούσας Εγγύησης είναι (i) πέντε (5) έτη από την ημερομηνία αγοράς του Προϊόντος, ή, στη λήξη των (ii) 30.000 ωρών χρήσης του Προϊόντος (στο εξής «**Περίοδος Εγγύησης**»). Η EIZO και οι Διανομείς δεν φέρουν καμία ευθύνη ή υποχρέωση όσον αφορά το Προϊόν σε σχέση με τον Αρχικό Αγοραστή ή οποιοδήποτε τρίτο μέρος, ούτε άλλη ευθύνη διαφορετική από αυτήν που παρέχεται στην παρούσα Εγγύηση.

Η EIZO και οι διανομείς της θα πάψουν να διατηρούν αποθέματα εξαρτημάτων (εκτός από τα εξαρτήματα σχεδιασμού) του προϊόντος μόλις περάσουν επτά (7) χρόνια αφότου διακοπεί η παραγωγή των εν λόγω εξαρτημάτων. Κατά την επισκευή της οθόνης, η EIZO και οι Διανομείς θα χρησιμοποιήσουν ανταλλακτικά επισκευής που συμμορφώνονται με τα πρότυπά μας για τη Διασφάλιση Ποιότητας. Αν δεν είναι εφικτή η επισκευή της μονάδας λόγω της κατάστασής της ή λόγω έλλειψης αποθεμάτων κάποιου σχετικού εξαρτήματος, η EIZO και οι διανομείς της ενδέχεται να σας προσφέρουν τη δυνατότητα αντικατάστασής της με προϊόν ισοδύναμων επιδόσεων αντί να την επισκευάσουν.

Η Εγγύηση ισχύει μόνο σε χώρες ή περιοχές όπου βρίσκονται οι Διανομείς. Η Εγγύηση δεν περιορίζει οποιαδήποτε νόμιμα δικαιώματα του Αρχικού Αγοραστή.

Λαμβανομένης υπόψη κάθε διάταξης της παρούσας Εγγύησης, η EIZO και οι Διανομείς δεν θα έχουν καμία απολύτως υποχρέωση σύμφωνα με την παρούσα Εγγύηση σε οποιαδήποτε από τις περιπτώσεις που διατυπώνονται κατωτέρω:

- (α) Τυχόν ελάττωμα του Προϊόντος που προκαλείται από ζημία κατά τη μεταφορά, τροποποίηση, αλλαγή, κατάχρηση, λανθασμένη χρήση, ατύχημα, λανθασμένη εγκατάσταση, καταστροφή, εσφαλμένη συντήρηση ή/και λανθασμένη επισκευή από τρίτο μέρος εκτός της EIZO και των Διανομέων,
- (β) Τυχόν ασυμβατότητα του Προϊόντος λόγω πιθανών τεχνικών καινοτομιών ή/και κανονισμών,
- (γ) Τυχόν επιδείνωση του αισθητήρα,
- (δ) Τυχόν επιδείνωση της απόδοσης οθόνης που προκαλείται από τη φθορά αναλώσιμων εξαρτημάτων όπως της οθόνης LCD ή/και του φωτός υποβάθρου, κτλ. (π.χ. αλλαγές στη φωτεινότητα, αλλαγές στην ομοιομορφία φωτεινότητας, αλλαγές στο χρώμα, αλλαγές στην ομοιομορφία χρώματος, ελαττώματα σε pixel περιλαμβανομένων των καμένων pixel, κτλ.),
- (ε) Τυχόν ελάττωμα του Προϊόντος που προκαλείται από εξωτερικό εξοπλισμό,
- (στ) Τυχόν ελάττωμα του Προϊόντος στο οποίο έχει τροποποιηθεί ή αφαιρεθεί ο γνήσιος αριθμός σειράς,
- (ζ) Τυχόν ελάττωμα του Προϊόντος που προκαλείται από διαρροή υγρού από την μπαταρία,
- (η) Τυχόν φυσιολογική φθορά του προϊόντος, ιδιαίτερα αυτής των αναλώσιμων, των αξεσουάρ ή/και των προσαρτημάτων (π.χ. μπαταρίες, κουμπιά, περιστρεφόμενα μέρη, τηλεχειριστήριο, καλώδια, Εγχειρίδιο Χρήστη, κτλ.), και
- (θ) Τυχόν παραμόρφωση, αποχρωματισμό ή/και διαστρέβλωση του εξωτερικού μέρους του προϊόντος, περιλαμβανομένης της επιφάνειας της οθόνης LCD.

Ο Αρχικός Αγοραστής για να δικαιούται υπηρεσίες επισκευής σύμφωνα με την Εγγύηση, θα πρέπει να παραδώσει το Προϊόν, με πληρωμένα τα μεταφορικά έξοδα, στην αρχική του συσκευασία ή σε άλλη επαρκή συσκευασία με ισότιμο βαθμό προστασίας, αναλαμβάνοντας τον κίνδυνο βλάβης ή/και απώλειας κατά τη μεταφορά, στον τοπικό Διανομέα. Ο Αρχικός Αγοραστής όταν ζητά υπηρεσίες επισκευής σύμφωνα με την Εγγύηση, θα πρέπει να προσκομίζει την απόδειξη αγοράς του Προϊόντος και την ημερομηνία της αγοράς.

Η Περίοδος Εγγύησης για οποιοδήποτε αντικατεστημένο ή/και επισκευασμένο προϊόν σύμφωνα με την παρούσα Εγγύηση λήγει στο τέλος της αρχικής Περιόδου Εγγύησης.

Η EIZO Ή ΟΙ ΔΙΑΝΟΜΕΙΣ ΔΕΝ ΕΥΘΥΝΟΝΤΑΙ ΓΙΑ ΟΠΟΙΟΔΗΠΟΤΕ ΒΛΑΒΗ Ή ΑΠΩΛΕΙΑ ΔΕΔΟΜΕΝΩΝ Ή ΑΛΛΩΝ ΠΛΗΡΟΦΟΡΙΩΝ ΠΟΥ ΑΠΟΘΗΚΕΥΟΝΤΑΙ ΣΕ ΟΠΟΙΟΔΗΠΟΤΕ ΜΕΣΟ Ή ΟΠΟΙΟΔΗΠΟΤΕ ΑΛΛΟ ΜΕΡΟΣ ΣΕ ΟΠΟΙΟΔΗΠΟΤΕ ΠΡΟΪΟΝ ΠΟΥ ΕΠΙΣΤΡΕΦΕΤΑΙ ΣΤΗΝ EIZO Ή ΣΕ ΔΙΑΝΟΜΕΑ ΓΙΑ ΕΠΙΣΚΕΥΗ.

Η EIZO ΚΑΙ ΟΙ ΔΙΑΝΟΜΕΙΣ ΔΕΝ ΠΑΡΕΧΟΥΝ ΚΑΜΙΑ ΠΕΡΑΙΤΕΡΩ ΕΓΓΥΗΣΗ, ΡΗΤΗ Ή ΣΥΝΕΠΑΓΟΜΕΝΗ, ΟΣΟΝ ΑΦΟΡΑ ΤΟ ΠΡΟΪΟΝ ΚΑΙ ΤΗΝ ΠΟΙΟΤΗΤΑ, ΤΗΝ ΑΠΟΔΟΣΗ, ΤΗΝ ΕΜΠΟΡΕΥΣΙΜΟΤΗΤΑ Ή ΤΗΝ ΚΑΤΑΛΛΗΛΟΤΗΤΑ ΤΟΥ ΓΙΑ ΟΠΟΙΟΔΗΠΟΤΕ ΣΥΓΚΕΚΡΙΜΕΝΗ ΧΡΗΣΗ. ΣΕ ΚΑΜΙΑ ΠΕΡΙΠΤΩΣΗ Η EIZO Ή ΟΙ ΔΙΑΝΟΜΕΙΣ ΔΕΝ ΘΑ ΕΥΘΥΝΟΝΤΑΙ ΓΙΑ ΚΑΜΙΑ ΑΠΟΛΥΤΩΣ ΤΥΧΑΙΑ, ΕΜΜΕΣΗ, ΕΙΔΙΚΗ, ΣΥΝΕΠΑΓΟΜΕΝΗ Ή ΑΛΛΗ ΒΛΑΒΗ (ΠΕΡΙΛΑΜΒΑΝΟΜΕΝΩΝ, ΜΕΤΑΞΥ ΑΛΛΩΝ, ΒΛΑΒΩΝ Ή ΑΠΩΛΕΙΑΣ ΚΕΡΔΩΝ, ΔΙΑΚΟΠΗΣ ΕΠΙΧΕΙΡΗΜΑΤΙΚΩΝ ΠΡΑΣΤΗΡΙΟΤΗΤΩΝ, ΑΠΩΛΕΙΑΣ ΕΠΙΧΕΙΡΗΜΑΤΙΚΩΝ ΠΛΗΡΟΦΟΡΙΩΝ Ή ΤΥΧΟΝ ΑΛΛΗΣ ΧΡΗΜΑΤΙΚΗΣ ΑΠΩΛΕΙΑΣ) ΠΟΥ ΠΡΟΚΥΠΤΕΙ ΑΠΟ ΤΗ ΧΡΗΣΗ Ή ΤΗΝ ΑΝΙΚΑΝΟΤΗΤΑ ΧΡΗΣΗΣ ΤΟΥ ΠΡΟΪΟΝΤΟΣ Ή ΤΥΧΟΝ ΑΛΛΗΣ ΣΥΝΔΕΣΗΣ ΜΕ ΤΟ ΠΡΟΪΟΝ, ΕΙΤΕ ΒΑΣΙΖΕΤΑΙ ΣΕ ΣΥΜΒΟΛΑΙΟ, ΒΛΑΒΗ, ΑΜΕΛΕΙΑ, ΑΥΣΤΗΡΗ ΕΥΘΥΝΗ Ή ΕΙΔΑΛΛΩΣ, ΑΚΟΜΗ ΚΙ ΕΑΝ Η EIZO Ή ΟΙ ΔΙΑΝΟΜΕΙΣ ΕΝΗΜΕΡΩΘΟΥΝ ΓΙΑ ΤΗΝ ΠΙΘΑΝΟΤΗΤΑ ΤΕΤΟΙΩΝ ΖΗΜΙΩΝ. Η ΕΞΑΙΡΕΣΗ ΑΥΤΗ ΠΕΡΙΛΑΜΒΑΝΕΙ ΕΠΙΣΗΣ ΟΠΟΙΟΔΗΠΟΤΕ ΕΥΘΥΝΗ ΕΝΔΕΧΕΤΑΙ ΝΑ ΠΡΟΚΥΨΕΙ ΑΠΟ ΑΞΙΩΣΕΙΣ ΤΡΙΤΟΥ ΜΕΡΟΥΣ ΚΑΤΑ ΤΟΥ ΑΡΧΙΚΟΥ ΑΓΟΡΑΣΤΗ. Η ΟΥΣΙΑ ΤΟΥ ΟΡΟΥ ΑΥΤΟΥ ΕΙΝΑΙ ΝΑ ΠΕΡΙΟΡΙΣΕΙ ΤΗΝ ΠΙΘΑΝΗ ΕΥΘΥΝΗ ΤΗΣ EIZO ΚΑΙ ΤΩΝ ΔΙΑΝΟΜΕΩΝ ΠΟΥ ΠΡΟΚΥΠΤΕΙ ΑΠΟ ΤΗΝ ΠΑΡΟΥΣΑ ΕΓΓΥΗΣΗ Ή/ΚΑΙ ΤΙΣ ΠΩΛΗΣΕΙΣ.

## ОГРАНИЧЕННАЯ ГАРАНТИЯ

EIZO Corporation (называемая в дальнейшем “EIZO”) и авторизованные EIZO дистрибуторы (называемые в дальнейшем “Дистрибуторы”) гарантируют, в соответствии с условиями и пунктами этой ограниченной гарантии (называемой в дальнейшем “Гарантия”), первичному покупателю (называемому в дальнейшем “Первоначальный покупатель”), который приобрел у EIZO или Дистрибуторов продукт, указанный в этом документе (называемый в дальнейшем “Продукт”), что EIZO или Дистрибуторы на свое усмотрение либо бесплатно отремонтируют, либо бесплатно заменят Продукт, если Первоначальный покупатель признает в пределах Гарантийного срока (определенного ниже), что Продукт неисправен или он поврежден процессе нормального использования продукта в соответствии с описанием в инструкции по эксплуатации, прилагаемой к Продукту (называемой в дальнейшем “Руководство пользователя”).

Гарантийный период ограничен сроком (i) пять (5) лет от даты приобретения Продукта или ограничен сроком (ii) 30 000 часов использования Продукта (называемый в дальнейшем “Гарантийный период”). EIZO и Дистрибуторы не несут никакой ответственности и не берут обязательств относительно Продукта по отношению к Первоначальному покупателю или по отношению к любым третьим сторонам, кроме обязательств, оговоренных в этой Гарантии.

Компания EIZO и ее дистрибуторы хранят детали изделия (за исключением деталей внешней конструкции) не более 7 (семи) лет после прекращения его выпуска. В случае ремонта монитора EIZO и Дистрибуторы будут использовать запчасти, которые соответствуют нашим стандартам QC (контроль качества). Если устройство невозможно отремонтировать из-за его состояния или отсутствия нужной детали, то вместо ремонта компания EIZO и ее дистрибуторы могут предлагать замену неисправного устройства на устройство с аналогичными характеристиками.

Гарантия действительна только в странах или регионах, где расположены Дистрибуторы. Гарантия не ограничивает никакие законные права Первоначального покупателя.

Несмотря на другие условия этой Гарантии EIZO и Дистрибуторы не несут никаких обязательств согласно этой Гарантии в любом из перечисленных ниже случаев:

- (а) Любые дефекты Продукта, вызванные повреждениями при перевозке, модификацией, изменением, неправильным обращением, неправильным использованием, авариями, неправильной установкой, стихийными бедствиями, неправильным уходом и/или неправильным ремонтом третьей стороной, отличной от EIZO или Дистрибуторов;
- (б) Любые несовместимости Продукта из-за технических усовершенствований и/или изменения технических норм;
- (в) Любое повреждение датчика;
- (г) Любые ухудшения работы дисплея, вызванные изнашиванием невосстановимых частей, таких как панель ЖКД и/или подсветка и т.д. (например, изменение в яркости, изменение в равномерности яркости, изменение в цветности, изменение в равномерности цветности, изменение в пикселях, включая выгоревшие пиксели и т.д.);
- (д) Любые дефекты Продукта, вызванные внешним оборудованием;
- (е) Любые дефекты Продукта, при которых оригинальный серийный номер был изменен или удален;
- (ж) Любые дефекты Продукта, вызванные протеканием батареек;
- (з) Любые естественные ухудшения продукта, в частности, вызванные износом расходных частей, принадлежностей и/или приспособлений (например, батареек, кнопок, вращающихся частей, пульта дистанционного управления, кабелей, Руководства пользователя и т.д.); и
- (и) Любые деформации, изменения цвета и/или коробления внешней поверхности продукта, включая поверхность панели ЖКД.

Чтобы получить техническое обслуживание в рамках Гарантии, Первоначальный покупатель должен доставить Продукт местному Дистрибутору, оплатив перевозку, в его оригинальной упаковке или в другой соответствующей упаковке, обеспечивающей равноценную степень защиты, принимая во внимание риск повреждения и/или утерю при транспортировке. При запросе технического обслуживания в рамках Гарантии Первоначальный покупатель должен предоставить свидетельство покупки продукта и даты покупки.

Гарантийный период для любого замененного и/или отремонтированного продукта в рамках Гарантии истекает в конце завершения срока действия оригинального Гарантийного периода.

EIZO ИЛИ ДИСТРИБУТОРЫ НЕ НЕСУТ ОТВЕТСТВЕННОСТИ ЗА ЛЮБЫЕ ПОВРЕЖДЕНИЯ ИЛИ УТЕРЮ ДАННЫХ ИЛИ ДРУГОЙ ИНФОРМАЦИИ, ХРАНЯЩИХСЯ НА КАКИХ-ЛИБО НОСИТЕЛЯХ ИНФОРМАЦИИ ИЛИ НА ЛЮБЫХ ДРУГИХ ЧАСТЯХ ПРОДУКТА, КОТОРЫЙ ВОЗВРАЩЕН EIZO ИЛИ ДИСТРИБУТОРАМ ДЛЯ РЕМОНТА.

EIZO И ДИСТРИБУТОРЫ НЕ ДАЮТ НИКАКОЙ ДАЛЬНЕЙШЕЙ ГАРАНТИИ, ВЫРАЖЕННОЙ ИЛИ ПОДРАЗУМЕВАЕМОЙ, ОТНОСИТЕЛЬНО ПРОДУКТА И ЕГО КАЧЕСТВА, ТЕХНИЧЕСКИХ ХАРАКТЕРИСТИК, ТОВАРНОСТИ ИЛИ СООТВЕТСТВИЯ ДЛЯ КАКОГО-ЛИБО ОПРЕДЕЛЕННОГО ИСПОЛЬЗОВАНИЯ. НИ ПРИ КАКИХ УСЛОВИЯХ EIZO ИЛИ ДИСТРИБУТОРЫ НЕ НЕСУТ ОТВЕТСТВЕННОСТИ ЗА ЛЮБОЙ СЛУЧАЙНЫЙ, КОСВЕННЫЙ, СПЕЦИАЛЬНЫЙ, ПОБОЧНЫЙ ИЛИ ИНОЙ УЩЕРБ (ВКЛЮЧАЯ, БЕЗ ОГРАНИЧЕНИЙ, УЩЕРБ ИЗ-ЗА НЕПОЛУЧЕННОЙ ПРИБЫЛИ, ПРЕРЫВАНИЯ БИЗНЕСА, ПОТЕРИ КОММЕРЧЕСКОЙ ИНФОРМАЦИИ ИЛИ ЛЮБЫЕ ДРУГИЕ ФИНАНСОВЫЕ ПОТЕРИ), ВОЗНИКШИЙ ИЗ-ЗА ИСПОЛЬЗОВАНИЯ ИЛИ НЕВОЗМОЖНОСТИ ИСПОЛЬЗОВАТЬ ПРОДУКТ ИЛИ В ЛЮБОЙ ДРУГОЙ СВЯЗИ С ПРОДУКТОМ, ЛИБО ОСНОВАННЫЙ НА КОНТРАКТНЫХ ОТНОШЕНИЯХ, ГРАЖДАНСКИХ ПРАВОНАРУШЕНИЯХ, НЕБРЕЖНОСТИ, ПРИЧИНЕНИЯ УЩЕРБА ТРЕТЬЕЙ СТОРОНЕ ИЛИ ЧЕМ-ЛИБО ЕЩЕ, ДАЖЕ ЕСЛИ EIZO ИЛИ ДИСТРИБУТОРЫ БЫЛИ УВЕДОМЛЕНЫ О ВОЗМОЖНОСТИ ТАКОГО УЩЕРБА. ЭТО ИСКЛЮЧЕНИЕ ТАКЖЕ ВКЛЮЧАЕТ ЛЮБЫЕ ОБЯЗАТЕЛЬСТВА, КОТОРЫЕ МОГУТ ВОЗНИКНУТЬ В РЕЗУЛЬТАТЕ ТРЕБОВАНИЙ ТРЕТЬЕЙ СТОРОНЫ В ОТНОШЕНИИ ПЕРВОНАЧАЛЬНОГО ПОКУПАТЕЛЯ. СУЩЕСТВОМ ЭТОГО ПОЛОЖЕНИЯ ЯВЛЯЕТСЯ ОГРАНИЧЕНИЕ ПОТЕНЦИАЛЬНОЙ ОТВЕТСТВЕННОСТИ EIZO И ДИСТРИБУТОРОВ, ВОЗНИКАЮЩЕЙ ИЗ-ЗА ЭТОЙ ОГРАНИЧЕННОЙ ГАРАНТИИ И/ЛИ ПРОДАЖ.



## 有限责任保证书

EIZO Corporation (以下简称“EIZO”)和 EIZO 授权的经销商 (以下简称“经销商”), 接受并依照本有限责任保证书 (以下简称“保证书”)之条款, 向从 EIZO 和经销商购买本文中所规定产品 (以下简称“产品”)的原买方 (以下称“原买方”)提供保证:在保证期内 (规定如下), 如果原买方发现按本产品所附使用说明书 (以下简称“用户手册”)所述方式正常使用本产品过程中, 本产品出现故障或损坏, EIZO 和经销商根据其独立的判断免费修理或更换该产品。

本保证期限定为(i)自本产品购买之日起的五(5)年期间或限定为到达(ii)使用本产品 3 万小时的期限(以下简称“保证期限”)。EIZO 和经销商将不向原买方或任何第三方承担本保证书所规定之外的与本产品有关任何责任或义务。

零件停产七(7)年后, EIZO 及其经销商不再保留或保存产品的任何零件 (设计零件除外)。维修显示器时, EIZO 与经销商将使用符合我方质量控制标准的替换零件。若由于自身条件或缺少相关零件而不能修理设备, EIZO 和经销商可提供性能相同的更换产品, 而无需维修。

本保证书仅对于设有经销商的国家或地区有效。本保证书并不限定原买方的任何法律权利。

无论本保证书的任何其他条款如何规定, 对于任何下列情况之一, EIZO 和经销商将不承担本保证书规定责任:

- (a) 由于运输损害、改装、改动、滥用、误用、意外事故、错误安装、灾害、维护不善和 / 或由除 EIZO 和经销商以外的第三方进行不适当的修理造成本产品的任何故障。
- (b) 由于可能发生的技术变更和 / 或调整造成本产品的任何不兼容性。
- (c) 传感器的任何劣化。
- (d) 由于诸如液晶显示屏 (LCD) 和 / 或背灯等消耗品部件的老化造成的任何显示性能低劣 (如亮度变化、亮度均一性变化、色彩变化、色彩均一性变化、如烧伤像素等像素缺陷)。
- (e) 因外部设备造成本产品的任何故障。
- (f) 因本产品的原序号被改变或消除造成本产品的任何故障。
- (g) 因电池液体泄漏造成本产品的任何故障。
- (h) 本产品的任何正常老化, 尤其是消耗品、附件和 / 或附加装置 (如电池、按钮、旋转部件、遥控器、电缆、用户手册等)、以及
- (i) 本产品表面包括液晶显示屏 (LCD) 表面的任何变形、变色和 / 翘曲。

为了获得本保证书规定的服务, 原买方必须使用原包装或其他具有同等保护程度的适当包装将本产品运送到当地的经销商, 并且预付运费, 承担运输中的损坏和 / 或损失的风险。要求提供本保证书规定的服务时, 原买方必须提交购买本产品和标明此购买日期的证明。

按本保证书规定进行了更换和 / 或修理的任何产品的保证期限, 将在原保证期限结束时终止。

在返回给 EIZO 和经销商进行修理后, 任何产品的任何媒体或任何部件中储存的数据或其他信息发生任何损坏或损失, 对此 EIZO 和经销商将不承担责任。

对于本产品及其质量、性能、可销售性以及对于特殊用途的适合性, EIZO 和经销商不提供其他任何明示或暗示的保证。因使用本产品或无法使用本产品或因与本产品有任何关系 (无论是否根据合同) 而造成:任何附带的、间接的、特殊的、随之发生的或其他的损害 (包括但不限于: 利润损失、业务中断、业务信息丢失或其他任何金钱损失) 以及侵权行为、过失、严格赔偿责任或其他责任, 即使已经向 EIZO 和经销商提出了发生这些损害的可能性, 对此 EIZO 和经销商概不承担责任。本免责条款还包括因第三方向原买方提出索赔而可能发生的任何责任。本条款的本质是限定由于本有限责任保证书和 / 或销售本产品所发生的 EIZO 和经销商的潜在责任。

# Recycling Information

---

## Recycling Information

This product, when disposed of, is supposed to be collected and recycled according to your country's legislation to reduce environmental burden. When you dispose of this product, please contact a distributor or an affiliate in your country.

The contact addressees are listed on the EIZO website below.

<http://www.eizoglobal.com>

For recycling information for customers in Switzerland, please refer to the following website.

<http://www.swico.ch>

## Informationen zum Thema Recycling

Dieses Produkt muss gemäß den Vorschriften Ihres Landes zur Entlastung der Umwelt recyclet werden. Wenden Sie sich bei der Entsorgung dieses Produkts an einen Verteiler oder eine Tochtergesellschaft in Ihrem Land.

Die Adressen zur Kontaktaufnahme sind auf der unten angegebenen Website von EIZO aufgeführt.

<http://www.eizoglobal.com>

Kunden in der Schweiz entnehmen Informationen zum Recycling der folgenden Website:

<http://www.swico.ch>

## Informations sur le recyclage

Ce produit doit être jeté aux points de collecte prévus à cet effet et recyclé conformément à la législation de votre pays, afin de réduire l'impact sur l'environnement. Lorsque vous jetez ce produit, veuillez contacter un distributeur ou une société affiliée de votre pays.

Les adresses des distributeurs sont répertoriées sur le site Web EIZO ci-dessous.

<http://www.eizoglobal.com>

Pour les clients en Suisse, veuillez consulter le site Web suivant afin d'obtenir des informations sur le recyclage.

<http://www.swico.ch>

## Información sobre reciclaje

Este producto debe desecharse y reciclarse según la legislación del país para reducir el impacto medioambiental. Cuando desee deshacerse de este producto, póngase en contacto con un distribuidor o una filial de su país.

Encontrará las direcciones de contacto en el sitio web de EIZO que se indica a continuación.

<http://www.eizoglobal.com>

## Informazioni sul riciclaggio

Per lo smaltimento e il riciclaggio del presente prodotto, attenersi alle normative vigenti nel proprio paese per ridurre l'impatto ambientale. Per lo smaltimento, rivolgersi ad un distributore o un affiliato presenti nel proprio paese.

Gli indirizzi sono elencati nel sito Web EIZO riportato di seguito.

<http://www.eizoglobal.com>

Per informazioni sul riciclaggio per i clienti in Svizzera, consultare il sito Web riportato di seguito.

<http://www.swico.ch>

## Återvinningsinformation

När denna produkt kasseras ska den hanteras och återvinnas enligt landets föreskrifter för att reducera miljöpåverkan. När du kasserar produkten ska du kontakta en distributör eller representant i ditt land.

Kontaktadresserna listas på EIZO-webbplatsen nedan.

<http://www.eizoglobal.com>

## Πληροφορίες ανακύκλωσης

Το προϊόν αυτό, όταν απορρίπτεται, πρέπει να συλλέγεται και να ανακυκλώνεται σύμφωνα με τη νομοθεσία της χώρας σας έτσι ώστε να μην επιβαρύνει το περιβάλλον. Για να απορρίψετε το προϊόν, επικοινωνήστε με έναν αντιπρόσωπο ή μια θυγατρική εταιρεία στη χώρα σας.

Οι διευθύνσεις επικοινωνίας αναγράφονται στην τοποθεσία web της EIZO παρακάτω.

<http://www.eizoglobal.com>

## Сведения по утилизации

По истечении срока службы данного продукта его следует принести на сборный пункт и утилизировать в соответствии с действующими предписаниями в вашей стране, чтобы уменьшить вредное воздействие на окружающую среду. Прежде чем выбросить данный продукт, обратитесь к дистрибьютору или в местное представительство компании в вашей стране.

Контактные адреса можно найти на веб-узле EIZO.

<http://www.eizoglobal.com>

## Informatie over recycling

Wanneer u dit product wilt weggooien, moet het uit milieu-overwegingen worden verzameld en gerecycled volgens de betreffende wetgeving van uw land. Wanneer u dit product wilt weggooien, moet u contact opnemen met een distributeur of een partner in uw land.

De contactadressen worden vermeld op de volgende EIZO-website.

<http://www.eizoglobal.com>

## Informação sobre reciclagem

Este produto, quando o deitar fora, deve ser recolhido e reciclado de acordo com a legislação do seu país para reduzir a poluição. Quando deitar fora este produto, contacte um distribuidor ou uma filial no seu país.

Os endereços de contacto estão listados no website do EIZO, abaixo.

<http://www.eizoglobal.com>

## Oplysninger om genbrug

Dette produkt forventes ved bortskaffelse at blive indsamlet og genbrugt i overensstemmelse med lovgivningen i dit land for at reducere belastningen af miljøet. Når du bortskaffer denne produkt, skal du kontakte en distributør eller et tilknyttet selskab i dit land.

Adresserne på kontaktpersonerne er angivet på EIZO's websted nedenfor.

<http://www.eizoglobal.com>

## Kierrätystä koskevia tietoja

Tuote tulee hävittää kierrättämällä maan lainsäädännön mukaisesti ympäristön kuormittumisen vähentämiseksi. Kun hävität tuotteen, ota yhteyttä jälleenmyyjään tai tytäryhtiöön maassasi.

Yhteystiedot löytyvät EIZOn Internet-sivustolta.

<http://www.eizoglobal.com>

## Wykorzystanie surowców wtórnych

Ten produkt po zużyciu powinien być zbierany i przetwarzany zgodnie z krajowymi przepisami dotyczącymi ochrony środowiska. Wyrzucając ten produkt, należy skontaktować się z lokalnym dystrybutorem lub partnerem. Adresy kontaktowe można znaleźć we wskazanej poniżej witrynie internetowej firmy EIZO.

<http://www.eizoglobal.com>

## Informace o recyklaci

Při likvidaci produktu musí být produkt vyzvednut a recyklován podle zákonů příslušné země, aby nedocházelo k zatěžování životního prostředí. Zbavujete-li se produktu, kontaktujte distributora nebo pobočku ve své zemi. Kontaktní adresy jsou uvedeny na následující webové stránce společnosti EIZO.  
<http://www.eizoglobal.com>

## Ringlussevõtu alane teave

Keskkonnakoormuse vähendamiseks tuleks kasutatud tooted kokku koguda ja võtta ringlusse vastavalt teie riigi seadustele. Kui kõrvaldate käesoleva toote, võtke palun ühendust turustaja või filiaaliga oma riigis. Kontaktisikud on toodud EIZO veebilehel järgmisel aadressil:  
<http://www.eizoglobal.com>

## Újrahasznosítási információ

Jelen terméket, amikor eldobjuk, az illető ország törvényei alapján kell összegyűjteni és újrahasznosítani, hogy csökkentsük a környezet terhelését. Amikor ezt a terméket eldobja, kérjük lépjen kapcsolatba egy országon belüli forgalmazóval vagy társvállalkozással.  
A kapcsolat címei az EIZO alábbi weboldalán találhatók felsorolva:  
<http://www.eizoglobal.com>

## Podatki o recikliranju

Ob koncu uporabe odslužen izdelek izročite na zbirno mesto za recikliranje v skladu z okoljevarstveno zakonodajo vaše države. Prosim, da se pri odstranjevanju izdelka obrnete na lokalnega distributerja ali podružnico.  
Kontaktne naslovi so objavljeni na spodaj navedenih spletnih straneh EIZO:  
<http://www.eizoglobal.com>

## Informácie o recyklácii

Pri likvidácii musí byť tento výrobok recyklovaný v súlade s legislatívou vašej krajiny, aby sa znížilo zaťaženie životného prostredia. Keď sa chcete zbaviť tohto výrobku, kontaktujte prosím distribútora alebo pobočku vo vašej krajine.  
Zoznam kontaktných adries je uvedený na nasledovnej webovej stránke firmy EIZO:  
<http://www.eizoglobal.com>

## Pārstrādes informācija

Utilizējot šo produktu, tā savākšana un pārstrāde veicama atbilstoši jūsu valsts likumdošanas prasībām attiecībā uz slodzes uz vidi samazināšanu. Lai veiktu šī produkta utilizāciju, sazinieties ar izplatītāju vai pārstāvniecību jūsu valstī.  
Kontaktadrese ir norādītas zemāk minētajā EIZO tīmekļa vietnē.  
<http://www.eizoglobal.com>

## Informacija apie gražinamąjį perdirbimą

Šalinant (išmetant) šiuos gaminius juos reikia surinkti ir perdirbti gražinamuju būdu pagal jūsų šalies teisės aktus, siekiant sumažinti aplinkos teršimą. Kai reikia išmesti šį gaminį, kreipkitės į jūsų šalyje veikiančią gaminių pardavimo atstovybę arba jos filiaalą.  
Kontaktiniai adresatai nurodyti EIZO interneto svetainėje.  
<http://www.eizoglobal.com>

## Информация относно рециклиране

При изхвърлянето на този продукт се предлага събирането и рециклирането му съобразно законите на вашата страна за да се намали замърсяването на околната среда. Когато искате да се освободите от този продукт, моля свържете се с търговския му представител или със съответните органи отговарящи за това във вашата страна.

Данните за връзка с нас са описани на следния Интернет сайт на EIZO:  
<http://www.eizoglobal.com>

## Informație referitoare la reciclare

Acest produs, când debarasat, trebuie colectat și reciclat conform legislației țării respective ca să reducem sarcina mediului. Când se debarasează de acest produs, vă rugăm să contactați un distribuitor sau un afiliat al țării respective.

Adresele de contact le găsiți pe pagina de web al EIZO:  
<http://www.eizoglobal.com>

## معلومات عن إعادة التدوير

عند التخلص من هذا المنتج، من الضروري تجميعه وإعادة تدويره وفقاً للقوانين المتبعة في بلدك لتقليل العبء المسلط على البيئة. عندما تتخلص من هذا المنتج، يرجى الاتصال بموزع أو طرف منتسب إليه في بلدك. عناوين الاتصال مدرجة في موقع ايزو EIZO ادناه على شبكة الانترنت.

<http://www.eizoglobal.com>

## Geri Dönüşüm Bilgisi

Bu ürünün, atılacağı zaman, ülkenizin çevre kirliliğinin azaltılması konusundaki mevzuatına göre toplanması ve yeniden değerlendirilmesi gerekmektedir. Ürünü atacağınız zaman lütfen ülkenizdeki bir distribütör veya ilgili kuruluşla temasa geçiniz.

İrtibat adresleri aşağıdaki EIZO web sitesinde verilmiştir.  
<http://www.eizoglobal.com>

