

# User's Manual

# ColorEdge® CG232W

Calibration Color LCD Monitor

## Important

Please read PRECAUTIONS, this User's Manual, and the Setup Manual (separate volume) carefully to familiarize yourself with safe and effective usage.

- 
- Please refer to the Setup Manual for basic information ranging from connection of the monitor to a PC to using the monitor.
  - The latest User's Manual is available for download from our web site:  
<http://www.eizo.com>
- 



---

---

<p>This product has been adjusted specifically for use in the region to which it was originally shipped. If operated outside this region, the product may not perform as stated in the specifications.</p>
--

---

---

No part of this manual may be reproduced, stored in a retrieval system, or transmitted, in any form or by any means, electronic, mechanical, or otherwise, without the prior written permission of EIZO NANAo CORPORATION.

EIZO NANAo CORPORATION is under no obligation to hold any submitted material or information confidential unless prior arrangements are made pursuant to EIZO NANAo CORPORATION's receipt of said information. Although every effort has been made to ensure that this manual provides up-to-date information, please note that EIZO monitor specifications are subject to change without notice.

---

---

Apple, Mac, Macintosh, iMac, eMac, Mac OS, MacBook, PowerBook, ColorSync, QuickTime, and iBook are registered trademarks of Apple Inc.

VESA is a registered trademark or a trademark of the Video Electronics Standards Association in the United States and other countries.

Windows, Windows Vista, Windows Media, SQL Server, and Xbox 360 are registered trademarks of Microsoft Corporation in the United States and other countries.

EIZO, the EIZO Logo, ColorEdge, DuraVision, FlexScan, FORIS, RadiForce, RadiCS, RadiNET, Raptor, and ScreenManager are registered trademarks of EIZO NANAo CORPORATION in Japan and other countries.

ColorNavigator, EIZO EasyPIX, EcoView NET, EIZO ScreenSlicer, i•Sound, Screen Administrator, and UniColor Pro are trademarks of EIZO NANAo CORPORATION.

All other company and product names are trademarks or registered trademarks of their respective owners.

---

---

# Notice for this monitor

---

Aside from general purposes like creating documents, viewing multimedia content, this product is also suited to applications such as graphics creation and digital photo processing, where accurate color reproduction is a priority.

This product has been adjusted specifically for use in the region to which it was originally shipped. If the product is used outside the region, it may not operate as specified in the specifications.

This product may not be covered by warranty for uses other than those described in this manual.

The specifications noted in this manual are only applicable when the following are used:

- Power cords provided with the product
- Signal cables specified by us

Only use optional products manufactured or specified by us with this product.

As it takes about 30 minutes for the performance of electrical parts to stabilize, adjust the monitor 30 minutes or more after the monitor power has been turned on.

Monitors should be set to a lower brightness to reduce changes in luminosity caused by long-term use and maintain a stable display.

When the screen image is changed after displaying the same image for extended periods of time, an afterimage may appear. Use the screen saver or power save function to avoid displaying the same image for extended periods of time.

Periodic cleaning is recommended to keep the monitor looking new and to prolong its operation lifetime. (Refer to [“Cleaning”](#) on the next page.)

The LCD panel is manufactured using high-precision technology. Although, missing pixels or lit pixels may appear on the LCD panel, this is not a malfunction. Percentage of effective dots: 99.9994% or higher.

The backlight of the LCD panel has a fixed lifetime. When the screen becomes dark or begins to flicker, please contact your dealer.

Do not press on the panel or edge of the frame strongly, as this may result in display malfunctions, such as interference patterns, etc. If pressure is continually applied to the panel, it may deteriorate or damage your panel. (If the pressure marks remain on the panel, leave the monitor with a black or white screen. The symptom may disappear.)

Do not scratch or press on the panel with any sharp objects, as this may result in damage to the panel. Do not attempt to brush with tissues as this may scratch the panel.

When the monitor is cold and brought into a room or the room temperature goes up quickly, dew condensation may occur on the interior and exterior surfaces of the monitor. In that case, do not turn the monitor on. Instead wait until the dew condensation disappears, otherwise it may cause some damage to the monitor.

---

## **Cleaning**

---

### **Attention**

- Chemicals such as alcohol and antiseptic solution may cause gloss variation, tarnishing, and fading of the cabinet or panel, and also quality deterioration of the image.
  - Never use any thinner, benzene, wax, and abrasive cleaner, which may damage the cabinet or panel.
- 

If necessary, the stains on the cabinet and panel surface can be removed by using the provided ScreenCleaner.

## **To use the monitor comfortably**

- An excessively dark or bright screen may affect your eyes. Adjust the brightness of the monitor according to the environmental conditions.
- Staring at the monitor for a long time tires your eyes. Take a 10-minute rest every hour.

# Table of Contents

<b>Cover</b> .....	<b>1</b>	<b>3. Setting Monitor</b> .....	<b>23</b>
<b>Notice for this monitor</b> .....	<b>3</b>	3-1. Setting Power Saving .....	23
Cleaning .....	4	Analog Input .....	23
To use the monitor comfortably .....	4	Digital Input.....	23
<b>Table of Contents</b> .....	<b>5</b>	3-2. Locking Button Operation.....	24
<b>1. Introduction</b> .....	<b>6</b>	3-3. Setting Power Indicator .....	24
1-1. Features .....	6	3-4. Setting Button Guide .....	24
1-2. Controls and Functions .....	7	<b>4.Troubleshooting</b> .....	<b>25</b>
1-3. Utility Disk.....	8	<b>5. Reference</b> .....	<b>28</b>
1-4. Basic Operation and Functions .....	9	5-1. Attaching an Arm.....	28
Basic Operation.....	9	5-2. Connecting More than Two PCs to the Monitor	29
Functions .....	10	5-3. Utilizing USB (Universal Serial Bus).....	30
<b>2. Adjusting Screen</b> .....	<b>11</b>	5-4. Specifications .....	31
2-1. Setting Screen Resolution.....	11	5-5. Glossary .....	35
Compatible Resolutions/Frequencies .....	11	<b>6. Preset Timing</b> .....	<b>37</b>
Setting Resolution.....	11	<b>FCC Declaration of Conformity</b> .....	<b>38</b>
2-2. Setting SDI Input Signal.....	12	<b>Hinweise zur Auswahl des richtigen Schwenkarms</b>	<b>für Ihren Monitor / Hinweis zur Ergonomie</b> .....
Setting Pseudo Interlace .....	12		<b>39</b>
Expanding Signal Output Range .....	12		
Setting SDI Signal .....	12		
Adjusting Sharpness .....	13		
Adjusting Display Area .....	13		
Selecting Effective Bits for a 12-Bit Signal .....	13		
2-3. Displaying Screen Correctly (Analog Input Only)	14		
.....	14		
2-4. Adjusting Color .....	17		
Simple Adjustment (Switching Color Mode).....	17		
Advanced Adjustments [Adjustment menu].....	18		
2-5. Changing Screen Size Ratio.....	20		
Changing Screen Size Ratio for Input Screen ..	20		
2-6. Setting Black Insertion .....	22		

---

# 1. Introduction

Thank you very much for choosing an EIZO Color Monitor.

## 1-1. Features

---

- 22.5" wide format LCD
- Wide color gamut of 97% of Adobe RGB
- Applicable to HDCP
- WUXGA(1920 × 1200)display compliant
- Supports SDI signal inputs (BNC: HD/SD-SDI x 2, or Dual Link SDI x 1)  
Resolution : 2048 dots x 1080 lines
- Supports SDI signal outputs (BNC x 2, Loop-through)
- Supports DVI / D-SUB signal inputs (DVI-D×1, D-SUB×1)  
[Horizontal scanning frequency]  
Analog : 26 - 92kHz  
Digital : 26 - 78kHz  
[Vertical scanning frequency]  
Analog : 23.8 - 86Hz  
Digital : 23.8 - 61Hz (VGA TEXT: 69 - 71Hz)  
[Frame Synchronous mode supported]: 23.8 - 30.5Hz, 47.5 - 61Hz
- Color Mode function reproduces color gamut and gamma compliant with [EBU/Rec.709/ SMPTE-C] broadcasting standards as well as the [DCI] digital cinema standard (Refer to "[2-4. Adjusting Color](#)" on page 17)
- Black insertion function for suppressing blur in moving images (Refer to "[2-6. Setting Black Insertion](#)" on page 22)
- Setting Pseudo Interlace (Refer to "[2-2. Setting SDI Input Signal](#)" on page 12)
- The provided "ColorNavigator" calibration software enables you to calibrate monitor characteristics and generate ICC profiles (for Windows) and Apple ColorSync profiles (for Macintosh) (Refer to "[1-3. Utility Disk](#)" on page 8)
- Smoothing function incorporated for the adjustment of an enlarged image
- Sharpness function (OutlineEnhancer)
- Height adjustable stand
- Attaching the "Adjustment Certificate" to describe the grayscale and uniformity characteristics of the monitor individually

## 1-2. Controls and Functions

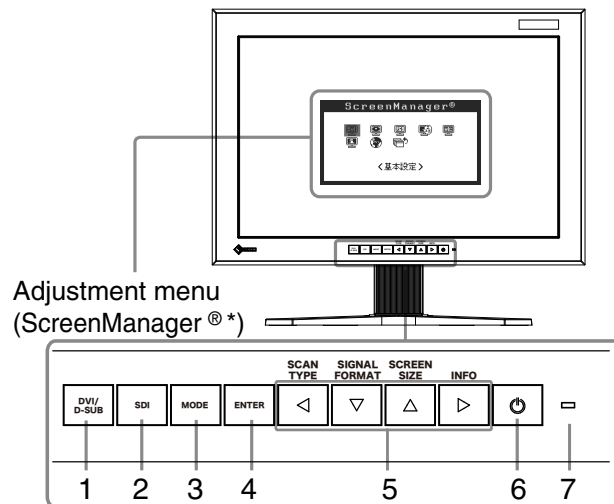

1. DVI / D-SUB Input Signal Selection button
2. SDI Input Signal Selection button
3. Mode button
4. Enter button
5. Control buttons (Left, Down, Up, Right)
6. Power button
7. Power indicator

Indicator status	Operation status
Blue	The screen is displayed
Flashing blue (2 times for each)	When the timer is set for ColorNavigator, notifies that a recalibration is required (for CAL mode).
Orange	Power saving
Off	Power off

\* ScreenManager® is an EIZO's nickname of the Adjustment menu.

## 1-3. Utility Disk

An “EIZO LCD Utility Disk” (CD-ROM) is supplied with the monitor. The following table shows the disk contents and the overview of the software programs.

### Disk contents and software overview

The disk includes software programs for adjustment and User’s Manual. Refer to “Readme.txt” or the “read me” file on the disk for software startup procedures or file access procedures.

Item	Overview	For Windows	For Macintosh
A “Readme.txt” or “read me” file		√	√
ColorNavigator	An application software for calibrating monitor characteristics and generating ICC profiles (for Windows) and Apple ColorSync profiles (for Macintosh). (A PC must be connected to the monitor with the supplied USB cable.) Refer to the description later.	√	√
Screen Adjustment Utility	Monitor pattern display software used when adjusting the image of the analog input signal manually.	√	–
Screen adjustment pattern files	Used when adjusting the image of the analog signal input manually. If the Screen Adjustment Utility is not applicable to your PC, use this pattern files to adjust the image.	√	–
User’s Manual (PDF file)		√	√

### To use ColorNavigator

Refer to the corresponding User’s Manual on the CD-ROM disk in order to install and use the software. When using this software, you will need to connect a PC to the monitor with the supplied USB cable. For more information refer to the "[5-3. Utilizing USB \(Universal Serial Bus\)](#)" (page 30).



## 1-4. Basic Operation and Functions

### Basic Operation

Adjustment menu allows you to adjust screen performance through the main menu and select a Color mode easily.

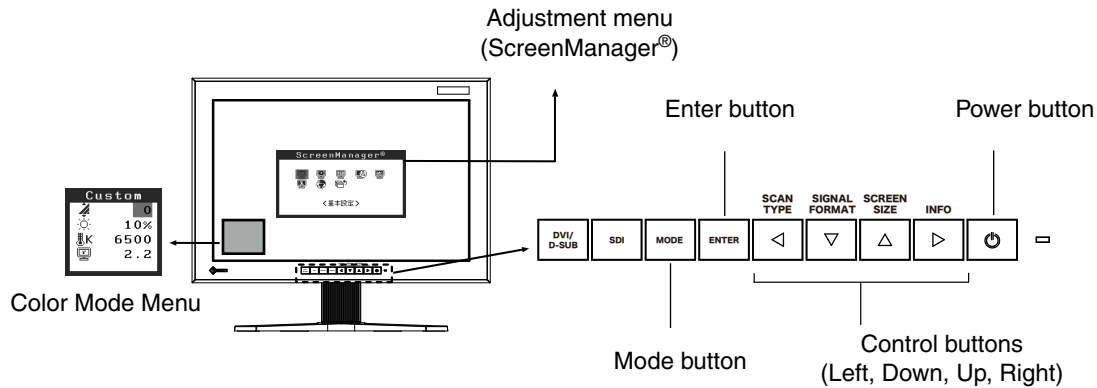

#### Note

- The Adjustment menu and the Color Mode menu cannot be displayed at the same time.

### 1 Entering the Adjustment menu



Press  once to display the main menu of the Adjustment menu.



### 2 Making Adjustments and Settings

1. Select the desired sub menu icon using , , ,  and press . The sub menu appears. (Regarding the sub menu, refer to the "Functions" (page 10)).
2. Use , , ,  to select the desired setting icon and press . The setting menu appears.
3. Use , , ,  to make all required adjustments and press  save the settings.

### 3 Exiting the Adjustment menu

1. To return to the main menu, select the <Return> icon  or press  twice, followed by .
2. To exit the Adjustment menu, select the <Exit> icon  or press  twice, followed by .

#### Tips

- Double clicking  at any time also exits the Adjustment menu.

## Functions

The following table shows all the Adjustment menu's adjustment and setting menus.

Main menu	Sub menu	SDI	DVI	D-SUB	Reference	
Setup	Black Insertion	√	√	√	"2-6. Setting Black Insertion" (page 22)	
	Pseudo Interlace	√	-	-	"2-2. Setting SDI Input Signal" (page 12)	
	Range Extension	√	-	-		
	SDI Settings	√	-	-		
	Reset	√	√	√		
Screen	Auto Adjustment	-	-	√	"2-3. Displaying Screen Correctly (Analog Input Only)" (page 14)	
	Clock	-	-	√		
	Phase	-	-	√		
	Position	-	-	√		
	Resolution	-	-	√		
	Range Adjustment	-	-	√	"2-5. Changing Screen Size Ratio" (page 20)	
	Screen Size	√	√	√		
	Smoothing	√	√	√	Switch mode if noise appears on the screen.	
	Signal Filter	-	-	√		
	Sharpness	√	-	-	"2-2. Setting SDI Input Signal" (page 12)	
	Display Area	√	-	-		
	12bit Mode	√	-	-		
Color (Custom)* <sup>1</sup>	Black Level	√	√	√	"2-4. Adjusting Color" (page 17)	
	Brightness	√	√	√		
	Temperature	√	√	√		
	Gamma	√	√	√		
	Saturation	√	√	√		
	Hue	√	√	√		
	Gain	√	√	√		
	Reset	√	√	√		
PowerManager	On	√	√	√	"3-1. Setting Power Saving" (page 23)	
	Off	√	√	√		
Others	Border Intensity	√	√	√	"Set the brightness of the black area surrounding the displayed image." (page 21)	
	Power Indicator	√	√	√	"3-3. Setting Power Indicator" (page 24)	
	Button Guide	√	√	√	"3-4. Setting Button Guide" (page 24)	
	Menu Settings	Menu Size	√	√	√	Change the size of the menu.
		Menu Position	√	√	√	Adjust the menu position.
		Menu Off Timer	√	√	√	Set the menu displaying time.
	Reset	√	√	√	Return to the factory Default settings.* <sup>2</sup>	
Information	Information	√	√	√	Review the Adjustment menu's settings, model name, serial number and usage time.* <sup>3</sup>	
Language	English, German, French, Spanish, Italian, Swedish, Chinese(Simplified), Chinese(Traditional) and Japanese	√	√	√	Select the Adjustment menu's language.	

\*<sup>1</sup> The adjustable functions on the <Color> menu depend on the selected Color mode (page 18). The above table shows the sub menus when the "Custom" mode is selected (See "2-4. Adjusting Color" (page 17)).

\*<sup>2</sup> The <Setup> settings are not reset.

\*<sup>3</sup> The usage time is not always "0" when you purchase the monitor due to factory inspection.

---

## 2. Adjusting Screen

### 2-1. Setting Screen Resolution

---

#### Compatible Resolutions/Frequencies

For details on compatible resolutions, refer to “Compatible Resolutions/Frequencies” in the Setup Manual.

#### Setting Resolution

When you connect the monitor to the PC and find that the resolution is improper, or when you want to change the resolution, follow the procedure below. When using video editing equipment, refer to the instruction manual for the equipment.

#### Windows Vista

1. Right-click the mouse anywhere on the desktop except for icons.
2. From the displayed menu, click “Personalize”.
3. On the “Personalization” window, click “Display Settings”.
4. On the “Display Settings” dialog, select the “Monitor” tab and select desired resolution in the “Resolution” field.
5. Click the “OK” button.
6. When a confirmation dialog is displayed, click “Yes”.

#### Windows XP

1. Right-click the mouse anywhere on the desktop except for icons.
2. From the displayed menu, click “Properties”.
3. When the “Display Properties” dialog is displayed, click the “Settings” tab and select desired resolution for “Screen resolution” under “Display”.
4. Click the “OK” button to close the dialog.

#### Mac OS X

1. Select “System Preferences” from the Apple menu.
2. When the “System Preferences” dialog is displayed, click “Displays” for “Hardware”.
3. On the displayed dialog, select the “Display” tab and select desired resolution in the “Resolutions” field.
4. Your selection will be reflected immediately. When you are satisfied with the selected resolution, close the window.

## 2-2. Setting SDI Input Signal

### Note

- These settings can only be made when using the SDI input signal.

The following settings are located on the <Setup> menu of the Adjustment menu.



### Setting Pseudo Interlace

This display method shows the interlaced signals as they are and gives the video a CRT-like display effect.

### Tips

- <Pseudo Interlace> can be set under these conditions:
  - The input signal is 1080i and the scan type on the <SDI Settings> menu is set to "Interlace".
  - The input signal is 1080i and the <SDI Settings> menu is set to "Auto" (default setting).

### [Procedure]

1. From the <Setup> menu on the Adjustment menu, select <Pseudo Interlace>.
2. Select "On".

### Note

- When <Pseudo Interlace> is set to "On", <Black Insertion> cannot be set.

### Expanding Signal Output Range

The signal range can be expanded to meet the input signal from 64/1023 - 1019/1023 to 0/1023 - 1023/1023.

### [Procedure]

1. From the <Setup> menu on the Adjustment menu, select <Range Extension>.
2. Select "On"

### Setting SDI Signal

This setting sets the scan type and signal format.

### [Procedure]

1. From the <Setup> menu on the Adjustment menu, select <SDI Settings>.
2. Select "Manual"
3. Select a scan type (Interlace, Progressive, or PsF).
4. Select a signal format (YUV 4:2:2, YUV 4:4:4, or RGB 4:4:4).

### Tips

- The signal format can be set if the SDI signal input is SDI-Dual (A-B) or SDI-Dual (B-A).
- The signal format is set to YUV 4:2:2 if the SDI input signal is SDI-1 or SDI-2.

The following settings are located on the <Screen> menu of the Adjustment menu.

## Adjusting Sharpness

Emphasizes the outline of the image by emphasizing the color difference between the pixels composing the image and to improve a sense of quality and materiality.

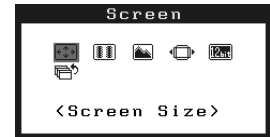

### Note

- <Sharpness> may not be adjustable for certain settings. (Refer to "4. Troubleshooting").

### [Procedure]

1. From the <Screen> menu on the Adjustment menu, select <Sharpness>.
2. Adjust the setting with   (0 to 10).

## Adjusting Display Area

The display area can be moved when using a 2048-by-1080 input signal.

### [Procedure]

1. From the <Screen> menu on the Adjustment menu, select <Display Area>.
2. Adjust the setting with   (2 to -2).

## Selecting Effective Bits for a 12-Bit Signal

This function selects the effective bits for displaying a 12-bit signal.

[11:2]: Displays a signal formed by the upper 10 bits. (Default setting)

[9:0]: Displays a signal formed by the lower 10 bits.

### Tips

- <12bit mode> can be set under these conditions.
  - The input signal is SDI-Dual (A-B) or SDI-Dual (B-A), and the <SDI Settings> (see previous page) menu is set to "Manual" and the signal format is set to "RGB4:4:4".
  - The input signal is SDI-Dual (A-B), SDI-Dual (B-A) or "RGB4:4:4", and the <SDI Settings> (see previous page) menu is set to "Auto".

### [Procedure]

1. From the <Screen> menu on the Adjustment menu, select <12bit mode>.
2. Select [11:2] or [9:0] with  .

---

## 2-3. Displaying Screen Correctly (Analog Input Only)

---

### Note

- Allow the LCD monitor to stabilize for at least 30 minutes before making image adjustments.

The monitor displays the digital input image correctly based on its pre-setting data.

The monitor screen adjustment is used to suppress flickering of the screen or adjust screen position and screen size correctly according to the PC to be used.

To use the monitor comfortably, adjust the screen when the monitor is set up for the first time or when the settings of the PC in use are updated.

### Adjustment Procedure

#### 1 Perform the auto screen adjustment.

1. From the <Screen> menu on the Adjustment menu, select <Auto Adjustment>.
2. Select "Execute"  
The Auto Adjustment function begins (showing a running status icon) to adjust flickering, screen position, and screen size automatically.

### Note

- The Auto Adjustment function is intended for use on the Macintosh and on AT-compatible PC running Windows. It does not work properly when an image is displayed only on a part of the screen (command prompt window, for example) or when a black background (wallpaper, etc.) is in use.
- It cannot work correctly using with some graphics cards.

If the screen is not displayed correctly after performing step 1, follow the steps below to adjust the screen. If the appropriate screen can be made, proceed to [5. Range Adjustment](#).

#### 2 Prepare the display pattern for the analog display adjustment.

##### Windows

1. Load the "EIZO LCD Utility Disk" to your PC.
2. Start the "Screen Adjustment Utility" from the startup menu. If it cannot be started, open the screen adjustment pattern files.

### Tips

- For how to open and use the screen adjustment pattern files, refer to "Readme.txt" file.

##### Other than Windows

Download the "Screen adjustment pattern files" from our site: <http://www.eizo.com>.

### Tips

- For details and instructions on opening the "Screen adjustment pattern files", refer to the "Read me" file.

### 3 Perform the auto size adjustment again with the analog screen adjustment pattern displayed.

1. Display Pattern 1 in full screen on the monitor using the "Screen Adjustment Utility" or the screen adjustment pattern files.

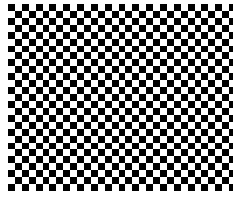



2. From the <Screen> menu on the Adjustment menu, select <Auto Adjustment>.
3. Select "Execute"  
The Auto Adjustment function begins (showing a running status icon) to adjust flickering, screen position, and screen size automatically.

### 4 Adjust by using <Screen> menu in the Adjustment menu

- (1) Vertical bars appear on the screen

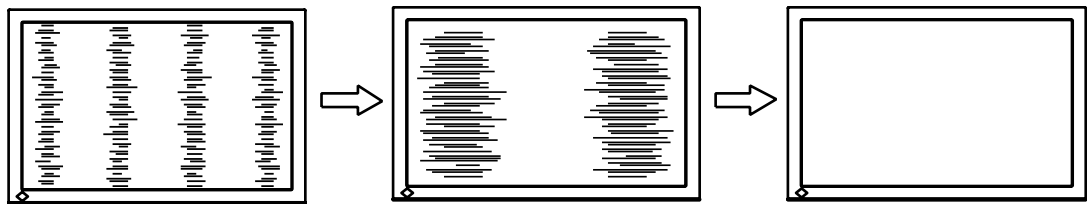

→  Use the <Clock> adjustment.

Select the <Clock> and eliminate the vertical bars by using  and  of the Control buttons. Do not continuously press the Control buttons, as the adjustment value will change quickly and make it difficult to locate the most suitable adjustment point. If the horizontal flickering, blur or bars appear, proceed to <Phase> adjustment as follows.



- (2) Horizontal flickering, blurring or bars appear on the screen.

→  Use the <Phase> adjustment.

Select the <Phase> and eliminate the horizontal flickering, blurring or bars by using  and  buttons.

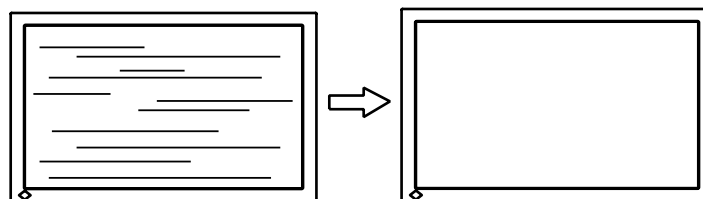

#### Note

- Horizontal bars may not completely disappear from the screen depending on the PC.

(3) The screen position is incorrect.

→  Use the <Position> adjustment.

The correct displayed position of the monitor is decided because the number and the position of the pixels are fixed. The <Position> adjustment moves the image to the correct position.

Select <Position> and use     to adjust the position so that the entire image is displayed. If vertical bars of distortion appear after finishing the <Position> adjustment, return to <Clock> adjustment and repeat the previously explained adjustment procedure. (“Clock” => “Phase” => “Position”)

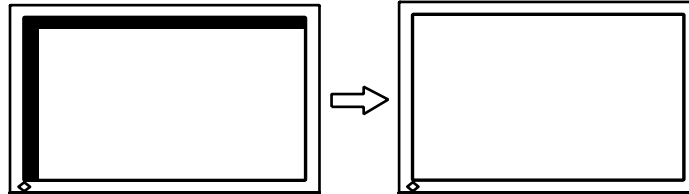

(4) Screen image is smaller or larger than the actual screen images.

→  Use the <Resolution> adjustment.

Adjustment is needed when the input signal resolution and the resolution now being displayed are different.

Select <Resolution> and confirm if the resolution now being displayed is the same as the input resolution. If it is not, adjust the vertical resolution using   and   and adjust the horizontal resolution using   and  .

Extra image is displayed due to excessive dots.

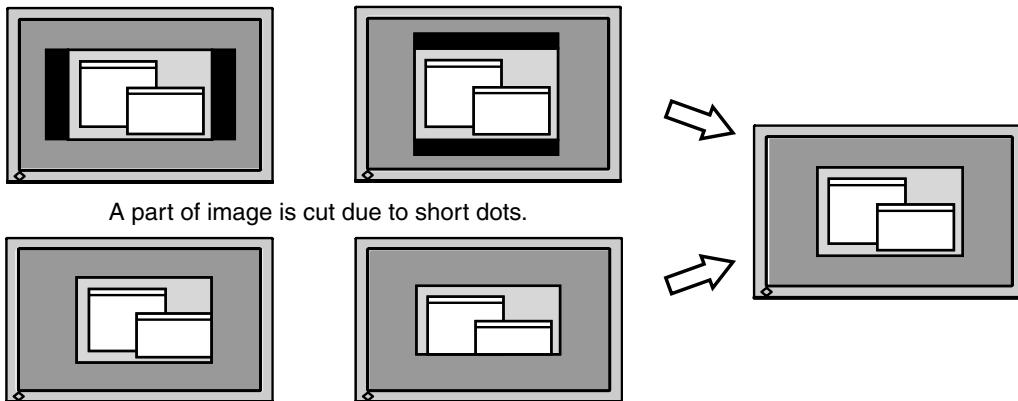

A part of image is cut due to short dots.

## 5 Adjust the output signal range (Dynamic Range) of the signal.

→  Use the <Range Adjustment> of <Screen> menu.

This controls the level of output signal range to display the whole color gradation (256 colors).

[Procedure]

1. Display Pattern 2 in full screen on the monitor using the “Screen Adjustment Utility” or the screen adjustment pattern files.

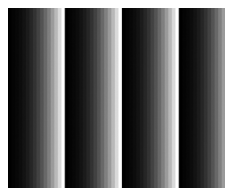

2. Choose <Range Adjustment> from the <Screen> menu, and press  .

3. Select “Execute”  
Color gradation is adjusted automatically.

4. Close the Pattern 2. When using the “Screen Adjustment Utility”, close the program.



## 2-4. Adjusting Color

### Simple Adjustment (Switching Color Mode)

Changing the color mode enables you to set the monitor to the appropriate display mode.

#### Selecting Color Mode

Pressing **[MODE]** displays the Color Mode menu at the bottom left of the screen. Each press of **[MODE]** changes through 7 modes.

Press **[ENTER]** to exit the menu.

->Custom->sRGB->EBU->Rec709->SMPTE-C->DCI->CAL

#### Tips

- The Adjustment menu and the Color Mode menu cannot be displayed at the same time.

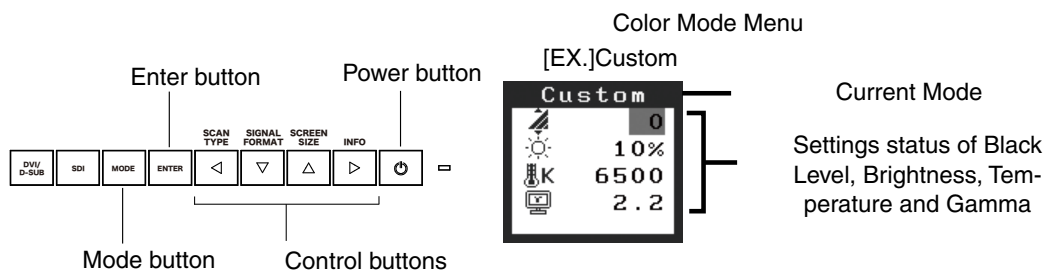

### Color Mode

Selectable Color modes are as follows.

Mode	Purpose
<b>Custom</b>	Available for the color settings according to your preference.
<b>sRGB</b>	Suitable for color matching with sRGB compatible peripherals.
<b>EBU</b>	Suitable for reproducing the color gamut and gamma as set forth by EBU (European Broadcasting Union) standards.
<b>Rec709</b>	Suitable for reproducing the color gamut and gamma as set forth by the ITU-R Rec. 709 standard.
<b>SMPTE-C</b>	Suitable for reproducing the color gamut and gamma as set forth by SMPTE-C standards.
<b>DCI</b>	Suitable for reproducing the color gamut and gamma as set forth by DCI standards.
<b>CAL</b>	Displays the screen adjusted by calibration software.

### Color Adjustment of the Mode Settings

<Black Level>, <Brightness>, <Temperature> and <Gamma> settings can be adjusted on the Color Mode menu. Select the desired function icon with **[▽]** **[△]** and adjust with **[◀]** **[▶]** Control buttons. (Setting(s) of <Temperature> and/or <Gamma> is defined as standard default in some modes.)

#### Note

- "CAL" mode can be adjusted only by Calibration Software "ColorNavigator".

## Advanced Adjustments [Adjustment menu]

Color settings of each Color mode can be adjusted and saved by using the <Color> menu of the Adjustment menu.

In the analog input, perform the “Range Adjustment” before making the color adjustments. During color adjustments, the color mode cannot be changed. Select the mode in advance by using MODE.

### Adjustment Items

The adjustable items and displayed icons on the <Color> menu depend on the selected color mode. Regarding the adjustment items, refer to the “Adjustment Contents” on the next page.

“√”: Settable/Adjustable “-”: Fixed at the factory









Icons	Functions		Color Mode						
			Custom	sRGB	EBU	Rec709	SMPTE-C	DCI	CAL
	Black Level	*	√	√	√	√	√	√	√
	Brightness	*	√	√	√	√	√	√	-
	Temperature	*	√	√	√	√	√	√	-
	Gamma	*	√	√	√	√	√	√	-
	Saturation		√	-	-	-	-	-	-
	Hue		√	-	-	-	-	-	-
	Gain		√	-	-	-	-	-	-
	Reset		√	√	√	√	√	√	√

\* These settings can be also adjusted on the Color Mode menu.

#### Note

- Allow the LCD monitor to stabilize for at least 30 minutes before making image adjustments. (Allow the monitor to warm up for at least 30 minutes before making adjustments.)
- The values shown in percentages represent the current level within the specific adjustment. They are available only as a reference tool. (To create a uniform white or black screen, the percentages for each will probably not be the same.)

## Adjustment Contents



Menu	Function Descriptions	Adjustable range
Black Level 	To adjust the black level as desired	0 - 32
Brightness 	To set the brightness of the screen	0~100%
Temperature 	To set the color temperature	5000K~10000K in 500 K increments (including 5400K and 9300 K)
	<b>Tips</b> <ul style="list-style-type: none"> <li>• The values shown in the “%” are available only as reference.</li> </ul>	
Gamma 	To set the gamma value	1.6 - 2.7
	<b>Tips</b> <ul style="list-style-type: none"> <li>• If setting the gamma value, the using the monitor in the digital signal input is recommended. If using the monitor in the analog input signal, set the gamma value from 1.8 to 2.2.</li> <li>• The default setting for each sRGB/EBU/REC709/SMPTE-C/DCI mode is set to “Std.”, which is the gamma in conformity with each standard.</li> </ul>	
Saturation 	To change the saturation	-100~100 Setting the minimum level (-100) turns the image to the monochrome.
	<b>Note</b> <ul style="list-style-type: none"> <li>• This function does not enable to display every color gradation.</li> </ul>	
Hue 	To change the flesh color, etc.	-100~100
	<b>Note</b> <ul style="list-style-type: none"> <li>• This function does not enable to display every color gradation.</li> </ul>	
Gain 	To change each color (red, green and blue)	0~100% By adjusting the red, green and blue color tones for each mode, custom colors can be defined. Display a white or gray background image and adjust the <Gain>.
	<b>Tips</b> <ul style="list-style-type: none"> <li>• The values shown in the “%” are available only as reference.</li> <li>• The &lt;Temperature&gt; setting invalidates this setting. The &lt;Gain&gt; setting varies with color temperature.</li> </ul>	
	<b>Note</b> <ul style="list-style-type: none"> <li>• This function does not enable to display every color gradation.</li> </ul>	
Reset 	To return the color settings to the default settings	Select the <Reset>.

## 2-5. Changing Screen Size Ratio

The screen size ratio can be selected using the <Screen Size> function on the <Screen> menu.

### Changing Screen Size Ratio for Input Screen

->  Select the <Screen Size>.

Select the <Screen Size> in the <Screen> menu and select the screen size by using  and .

#### When using DVI/D-SUB input signal

Mode	Function
Enlarged	Displays the picture on the screen in full, irrespective of the picture's resolution. Since the vertical resolution and horizontal resolution are enlarged at same rates, some horizontal or vertical image may disappear.
Normal	Displays the picture on the screen using the same resolution of the input signal.

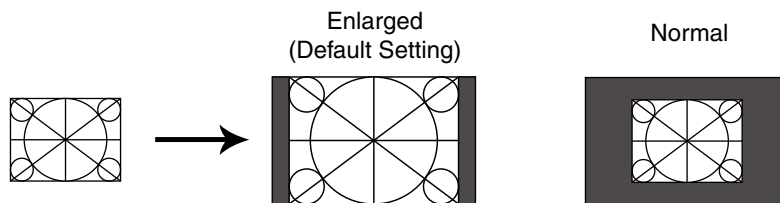

#### When using SDI input signal (input signal NTSC or PAL)

Mode	Function
Dot by Dot	Displays the picture on the screen using the same resolution of the input signal.
4:3	Displays the input video expanded to a vertical resolution of 1080 while maintaining the aspect ratio to 4:3 (horizontal: vertical).
16:9	Displays the input video expanded to a vertical resolution of 1080 while maintaining the aspect ratio to 16:9 (horizontal: vertical).
Letter Box	Displays the letter box input video expanded to a vertical resolution of 1080 while maintaining the aspect ratio.

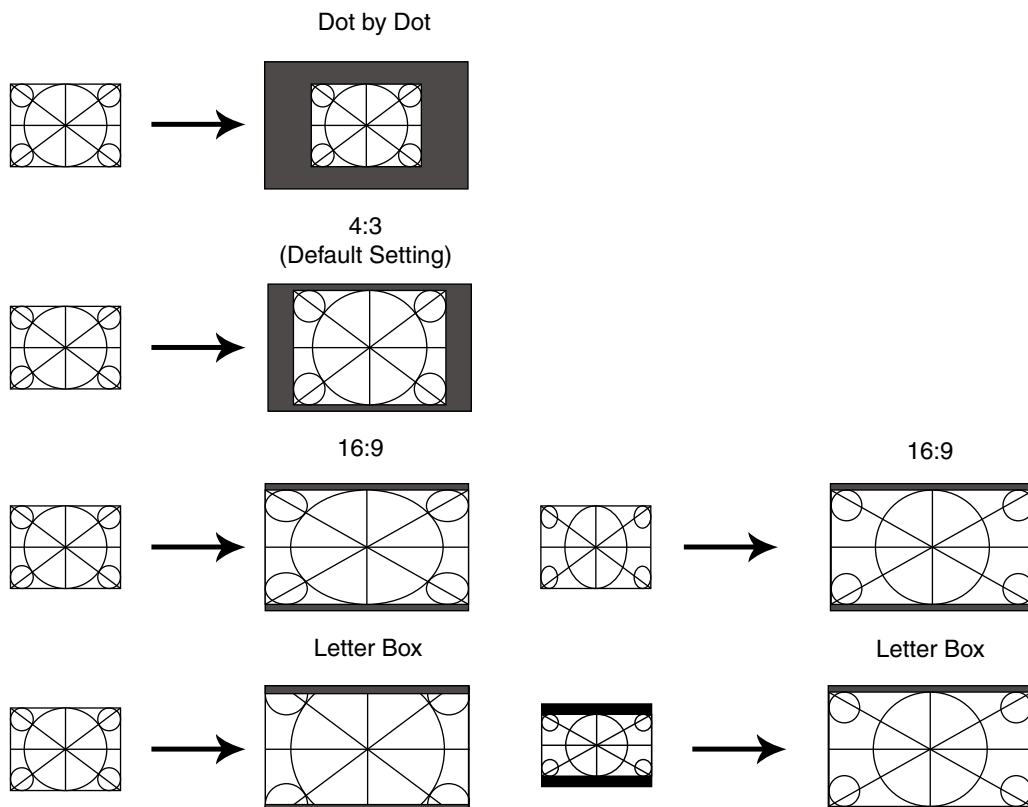

**When using SDI input signal (input signal 720p)**

Mode	Function
Dot by Dot	Displays the picture on the screen using the same resolution of the input signal.
Enlarged	Displays the input video expanded to a vertical resolution of 1080 while maintaining the aspect ratio.

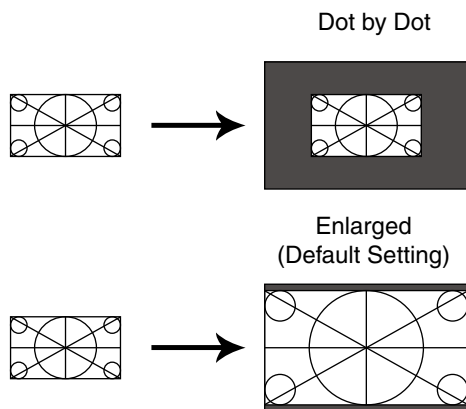

The setting must be adjusted in the following instances after changing the screen size ratio.

**Smooth the blurred texts of the enlarged screen.**

→  Switch the <Smoothing> setting.

Select the suitable level from 1 - 5 (Soft - Sharp).

Select <Smoothing> in the <Screen> menu and adjust by using the right and left switches.

**Note**

- Smoothing setting may not be required depending on the display resolution. (You cannot choose the smoothing icon.)

**Set the brightness of the black area surrounding the displayed image.**

→  Set the <Border Intensity>.

In "Normal" or "Enlarged" mode, the outer area (border) may appear black.

Select <BorderIntensity> in the <Others> menu and adjust by using  .

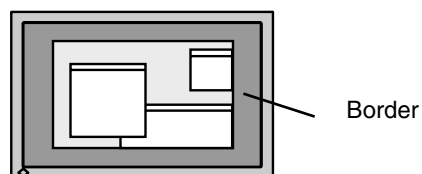

## 2-6. Setting Black Insertion

---

This setting inserts a black screen to suppress blur when showing moving images.

### [Procedure]

1. From the <Setup> menu on the Adjustment menu, select <Black Insertion>.
2. Select "On"

---

### Note

- The brightness may drop when set to "On".
  - When set to "On", the screen may flicker if the DVI/D-SUB input signal exceeds the frame sync frequency range.
  - When set to "On", the brightness will not change even if set to 45% or more.
-

## 3. Setting Monitor

### 3-1. Setting Power Saving

The <PowerManager> menu in the Adjustment menu enables to set the power saving.

#### Note

- Do your part to conserve energy, turn off the monitor when you are finished using it. Turning off the main power switch or unplugging the power cord completely shuts off power supply to the monitor.
- Devices connected to the USB port (upstream and downstream) work when the monitor is in power saving mode or when the power button of the monitor is Off. Therefore, power consumption of the monitor varies with connected devices even in the power saving mode.
- When using ColorNavigator, turning of the power saving function is recommended.

#### Analog Input

This monitor complies with the “VESA DPM”.

#### [Procedure]

1. Set the PC's power saving settings.
2. Select “On” from the <PowerManager> menu.

#### [Power Saving System]

	PC	Monitor	Power Indicator
	ON	Operation	Blue
Power saving	STAND-BY SUSPEND OFF	Power saving	Orange

#### [Power Resumption Procedure]

Operate the mouse or keyboard to return to a normal screen.

#### Digital Input

- DVI: This monitor complies with the DVI DMPM standard.
- SDI: This monitor complies with our original power saving function “SDI”.

#### [Procedure]

1. Set the PC's power saving settings.
2. Select “On” from the <PowerManager> menu.

#### [Power Saving System]

The monitor enters the power saving mode in five seconds in connection with the PC setting.







PC or Video Editing Equipment	Monitor	Power Indicator
ON	Operation	Blue
Power saving	Power saving	Orange

#### [Power Resumption Procedure]



Operate the mouse or keyboard to return to a normal screen.

## 3-2. Locking Button Operation



Use the “Adjustment Lock” function to prevent any accidental changes.

Buttons that can be locked	<ul style="list-style-type: none"> <li>•  (Enter button) / Adjustments/settings using</li> <li>•  (Mode button)</li> </ul>
Buttons that cannot be locked	<ul style="list-style-type: none"> <li>•  (DVI/D-SUB Input Signal Selection button)</li> <li>•  (SDI Input Signal Selection button)</li> <li>•  (Power button)</li> <li>•  (Control buttons)</li> </ul>

### [How to lock]

1. Press  to turn off the monitor.
2. Press  again while pressing .  
The screen is displayed with the adjustment lock.



### [How to unlock]

1. Press  to turn off the monitor.
2. Press  again while pressing .  
The screen is displayed with the adjustment lock released.

## 3-3. Setting Power Indicator

The brightness of the power indicator (blue) when the screen is displayed can be adjusted (default setting is set to light up when power is turned on, and brightness is set to 4).

### [Procedure]

1. Select <Power Indicator> in the Adjustment menu <Others> menu.
2. Set the brightness with   (Off or 1 to 7).

## 3-4. Setting Button Guide

The Button Guide can be changed between show/hide (default setting is set to show the Button Guide).

### [Procedure]





1. Select <Button Guide> in the Adjustment menu <Others> menu.
2. Select “On” or “Off”.





# 4.Troubleshooting

If a problem still remains after applying the suggested remedies, contact your local dealer.

- No-picture problems : See No.1 - No.2
- Imaging problems : See No.3 - No.16
- Other problems : See No.17 - No.21
- USB problems : See No.22

Problems	Possible cause and remedy
<p>1. No picture</p> <ul style="list-style-type: none"> <li>• Power indicator does not light.</li> </ul> <hr/> <ul style="list-style-type: none"> <li>• Power indicator is lighting blue.</li> </ul> <hr/> <ul style="list-style-type: none"> <li>• Power indicator is lighting orange.</li> </ul>	<ul style="list-style-type: none"> <li>• Check whether the power cord is connected correctly. If the problem persists, turn off the monitor, and then turn it on again a few minutes later.</li> <li>• Turn the main power switch on.</li> <li>• Press .</li> </ul> <hr/> <ul style="list-style-type: none"> <li>• Set each adjusting value in &lt;Brightness&gt; or &lt;Gain&gt; to higher level (<a href="#">page 18</a>).</li> </ul> <hr/> <ul style="list-style-type: none"> <li>• Switch the input signal with  or .</li> <li>• Operate the mouse or keyboard.</li> <li>• Check whether the PC is turned on.</li> <li>• Check whether the signal cable is connected properly.</li> </ul>
<p>2. The message below appears.</p> <hr/> <ul style="list-style-type: none"> <li>• This message appears when no signal is input. (This is displayed for about 40 seconds)</li> </ul> <div data-bbox="327 1055 635 1216" style="border: 1px solid black; padding: 5px; margin-bottom: 10px;"> <p style="text-align: center;"><b>Signal Check</b></p> <p style="text-align: center;">D-SUB</p> <p style="text-align: center;">fH: 0.0kHz fV: 0.0Hz</p> </div> <div data-bbox="327 1238 635 1400" style="border: 1px solid black; padding: 5px;"> <p style="text-align: center;"><b>Signal Check</b></p> <p style="text-align: center;">SDI-1</p> <p style="text-align: center;">No Signal</p> </div> <hr/> <ul style="list-style-type: none"> <li>• The message below shows that the input signal is out of the specified frequency range. (Such signal frequency is displayed in red.)</li> </ul> <p>Example:</p> <div data-bbox="327 1563 635 1724" style="border: 1px solid black; padding: 5px; margin-bottom: 10px;"> <p style="text-align: center;"><b>Signal Error</b></p> <p style="text-align: center;">D-SUB</p> <p style="text-align: center;">fH: 110.0kHz fV: 75.0Hz</p> </div> <div data-bbox="327 1747 635 1908" style="border: 1px solid black; padding: 5px;"> <p style="text-align: center;"><b>Signal Error</b></p> <p style="text-align: center;">DVI</p> <p style="text-align: center;">fD: 165.0MHz fH: 75.0kHz fV: 60.0Hz</p> </div>	<p>This message appears when the signal is not input correctly even when the monitor functions properly.</p> <hr/> <ul style="list-style-type: none"> <li>• The message shown left may appear, because some PCs do not output the signal soon after power-on.</li> <li>• Check whether the PC is turned on.</li> <li>• Check whether the signal cable is connected properly.</li> <li>• Switch the input signal with  or .</li> </ul> <hr/> <ul style="list-style-type: none"> <li>• Check whether the signal setting of your PC matches the resolution and the vertical frequency settings for the monitor (<a href="#">page 11</a>).</li> <li>• Reboot the PC.</li> <li>• Select an appropriate display mode using the graphics board's utility. Refer to the manual of the graphics board for details.</li> </ul> <p>fD: Dot Clock (Displayed only when the digital signal inputs)</p> <p>fH: Horizontal Frequency</p> <p>fV: Vertical Frequency</p>
<p>3. Display position is incorrect.</p> <div data-bbox="375 1973 587 2094" style="border: 1px solid black; width: 100px; height: 50px; margin: 10px auto;"></div>	<ul style="list-style-type: none"> <li>• Move the image to the correct position using the &lt;Position&gt; adjustment. (<a href="#">page 16</a>).</li> <li>• If the problem persists, use the graphics board's utility if available to change the display position.</li> </ul>

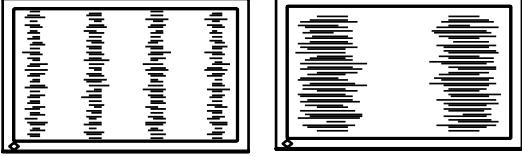
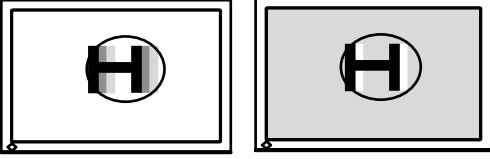
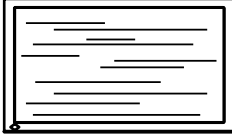
## 4. Troubleshooting

Problems	Possible cause and remedy
4. Screen image displayed is smaller or larger than the actual screen image.	<ul style="list-style-type: none"> <li>Adjust the resolution using &lt;Resolution&gt; so that the input signal resolution equals the resolution in the resolution adjustment menu (page 16).</li> </ul>
5. Vertical bars appear on the screen or a part of the image is flickering. <div style="display: flex; justify-content: space-around; margin-top: 10px;">  </div>	<ul style="list-style-type: none"> <li>Adjust using &lt;Clock&gt; (page 15).</li> </ul>
6. The characters and images have several vertical bars on their right side. <div style="display: flex; justify-content: space-around; margin-top: 10px;">  </div>	<ul style="list-style-type: none"> <li>Adjust the characters and images using the &lt;Signal Filter&gt;.</li> </ul>
7. Whole screen is flickering or blurring. <div style="display: flex; justify-content: center; margin-top: 10px;">  </div>	<ul style="list-style-type: none"> <li>Adjust using &lt;Phase&gt; (page 15).</li> </ul>
8. Characters are blurred.	<ul style="list-style-type: none"> <li>Adjust using &lt;Smoothing&gt; (page 21).</li> </ul>
9. Upper part of the screen is distorted as shown below. <div style="display: flex; justify-content: center; margin-top: 10px;">  </div>	<ul style="list-style-type: none"> <li>This is caused when both composite sync (X-OR) signal and separate vertical sync signal are input simultaneously. Select either composite signal or separate signal</li> </ul>
10. The screen is too bright or too dark.	<ul style="list-style-type: none"> <li>Adjust &lt;Brightness&gt;. (The LCD monitor backlight has a fixed life span. When the screen becomes dark or begins to flicker, contact your local dealer.)</li> </ul>
11. Afterimages appear.	<ul style="list-style-type: none"> <li>Use a screen saver for a long-time image display.</li> <li>Afterimages are particular to LCD monitors. Avoid displaying the same image for a long time.</li> </ul>
12. Green/red/blue/white dots or defective dots remain on the screen.	<ul style="list-style-type: none"> <li>This is due to LCD panel characteristics and is not a failure.</li> </ul>
13. Interference patterns or fingerprints remain on the screen.	<ul style="list-style-type: none"> <li>Leave the monitor with a white screen or a black screen. The symptom may disappear.</li> </ul>
14. Noise appears on the screen.	<ul style="list-style-type: none"> <li>When entering the signals of analog input, select 1 to 4 in &lt;Signal Filter&gt; from the &lt;Screen&gt; menu to change the mode.</li> <li>When entering the signals of HDCP system, the normal images may not be displayed immediately.</li> </ul>
15. The screen flickers.	<ul style="list-style-type: none"> <li>Set &lt;Black Insertion&gt; to "Off" on the &lt;Screen&gt; menu.</li> <li>Change the input signal to a sync signal.</li> </ul>
16. Screen does not appear correctly when using SDI input signal.	<ul style="list-style-type: none"> <li>Check whether the scan type is set correctly.</li> <li>Check whether the signal format is set correctly.</li> <li>Check whether the &lt;Screen Size&gt; is set correctly.</li> <li>Check the SDI settings.</li> </ul>

Problems	Possible cause and remedy
17.The <Smoothing> icon on the Adjustment menu <Screen> cannot be selected.	<ul style="list-style-type: none"> <li>• Smoothing setting may not be required depending on the display resolution. (You cannot choose the smoothing icon.)</li> <li>• &lt;Smoothing&gt; is disabled when the screen is displayed in the following resolutions. <ul style="list-style-type: none"> <li>• 1920 x 1200 or higher</li> <li>• 800 x 600, selecting [Enlarged] during &lt;Screen Size&gt;</li> <li>• 960 x 600, selecting [Enlarged] during &lt;Screen Size&gt;</li> <li>• 1600 x 1200, selecting [Enlarged] during &lt;Screen Size&gt;</li> <li>• Selecting “Dot by Dot” or “Normal” during &lt;Screen Size&gt;</li> <li>• Using an SDI input signal other than NTSC, PAL, or 720p</li> </ul> </li> </ul>
18.The <Sharpness> icon on the Adjustment menu <Screen> cannot be selected.	<ul style="list-style-type: none"> <li>• &lt;Smoothing&gt; is disabled when the screen is displayed in the following resolutions. <ul style="list-style-type: none"> <li>• Using a DVI/D-SUB input signal</li> <li>• 1920 x 1200 or higher</li> <li>• 800 x 600, selecting [Enlarged] during &lt;Screen Size&gt;</li> <li>• 960 x 600, selecting [Enlarged] during &lt;Screen Size&gt;</li> <li>• 1600 x 1200, selecting [Enlarged] during &lt;Screen Size&gt;</li> <li>• Selecting “Dot by Dot” during &lt;Screen Size&gt;</li> <li>• Using an SDI input signal other than NTSC, PAL, or 720p</li> </ul> </li> </ul>
19.The Main menu of Adjustment menu does not start.	<ul style="list-style-type: none"> <li>• Check for Adjustment Lock function (<a href="#">page 24</a>).</li> </ul>
20.The Color Mode menu does not start.	<ul style="list-style-type: none"> <li>• Check for Adjustment Lock function (<a href="#">page 24</a>).</li> </ul>
21.The auto adjust function does not work correctly.	<ul style="list-style-type: none"> <li>• This function does not work when digital signal is input.</li> <li>• This function does not work correctly with some graphics boards.</li> </ul>
22.The monitor connected with the USB cable is not detected. / USB devices connected to the monitor does not work.	<ul style="list-style-type: none"> <li>• Check that the USB cable is correctly connected.</li> <li>• Check the downstream ports by connecting the peripherals to other downstream ports. If the problem is solved by doing this, contact an EIZO dealer. (For details, refer to the manual of the PC.)</li> <li>• Reboot the PC</li> <li>• If the peripheral devices work correctly when the PC and peripheral devices are connected directly, please contact your local dealer.</li> <li>• Check that the PC and OS are USB compliant. (For verification of USB support, consult the manufacturer of each system.)</li> <li>• Check the PC’s BIOS setting for USB when using windows. (For details, refer to the manual of the PC.)</li> </ul>

# 5. Reference

## 5-1. Attaching an Arm

The stand can be removed and replaced with an arm (or another stand) to be attached to the monitor.

**Note**

- When attaching an arm or stand, follow the instructions of their user's manual.
- When using another manufacturer's arm or stand, confirm the following in advance and select one conforming to the VESA standard.
  - Hole spacing on the arm mounting: 100 mm x 100 mm
  - Thickness of plate: 2.6 mm
  - Strong enough to support weight of the monitor unit (except the stand) and attachments such as cables.
- When using an arm or stand, attach it to meet the following tilt angles of the monitor.
  - Up 45 degrees, down 45 degrees (horizontal display)
- Please connect cables after attaching an arm stand.
- Since the monitor and arm are so heavy, dropping them may result in injury or equipment damage.

### Setup Procedure

**1 Lay the LCD monitor on a soft cloth spread over on a stable surface with the panel surface facing down.**

**2 Remove the stand. (Prepare a screwdriver.)**

Unscrew the four screws securing the unit and the stand with the screwdriver.

**3 Attach an arm stand to the LCD monitor securely.**

Secure the monitor to the arm or stand using the screws specified in the user's manual of the arm or stand.

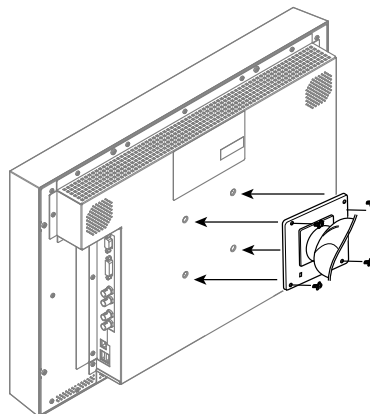

## 5-2. Connecting More than Two PCs to the Monitor

More than two PCs can be connected to the monitor through the D-Sub mini 15 pin, the DVI-D and the SDI (BNC) connector on the back of the monitor.

### Connection examples

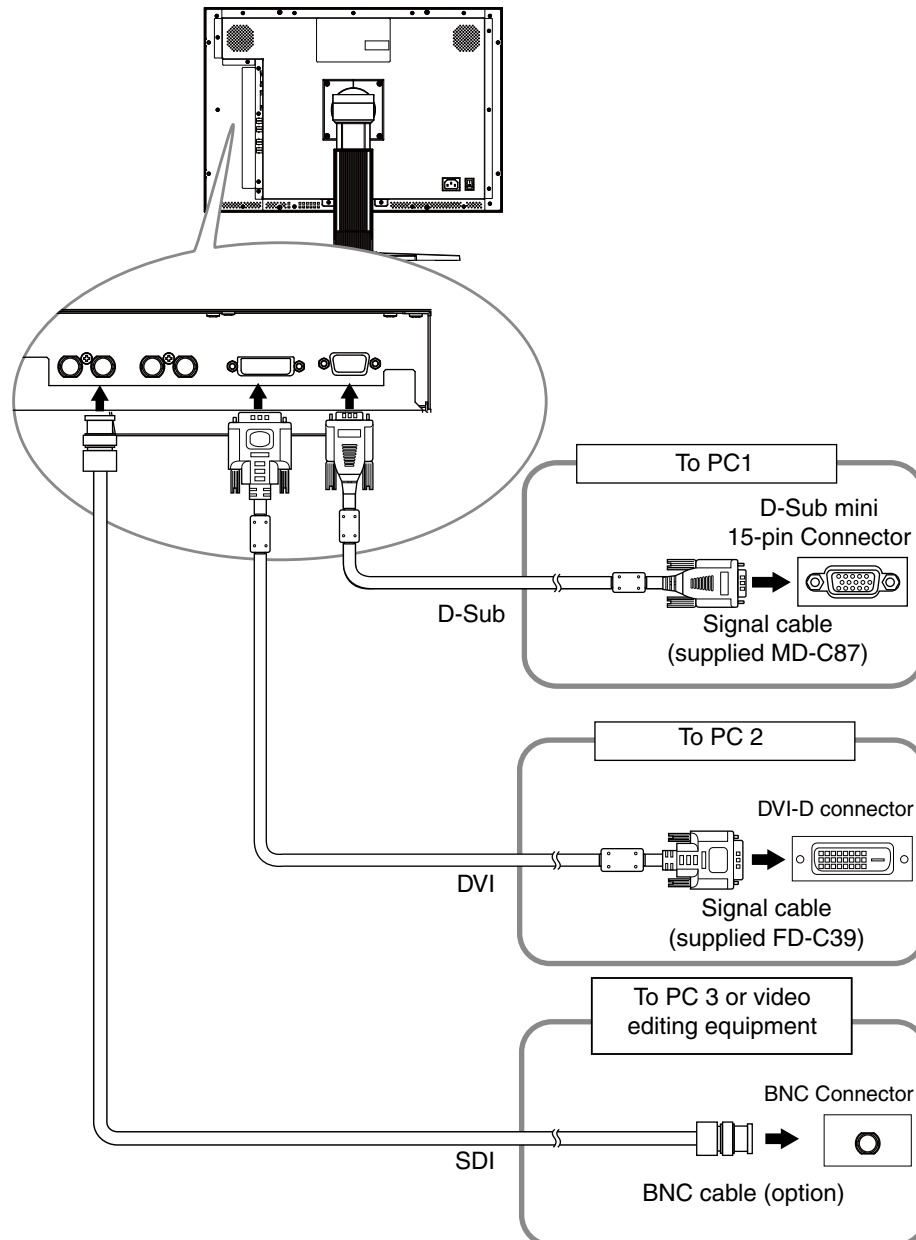

### Selecting input signal

Switch the input signal with  or . When the signal is switched, the active signal type (DVI, D-SUB or SDI) appears at the top right corner of the screen.

Input Signal Selection button

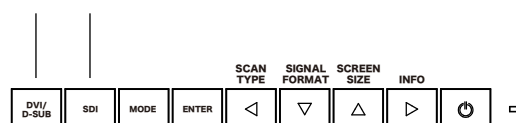

## 5-3. Utilizing USB (Universal Serial Bus)

This monitor provides a hub which supports the USB standard. When connecting to a USB compliant PC or another hub, the monitor functions as a hub to which the USB compliant peripherals can be easily connected.

### Required system environment

- PC equipped with USB ports or another USB hub connected to the USB compliant PC
- Windows 2000/XP/Vista // Mac OS 9.2.2/Mac OS X 10.2 or later
- USB Cable (MD-C93, enclosed)

### Note

- The USB hub function may not work properly depending on the PC or peripherals. Please consult the manufacturer of each device about the USB support.
- Using the USB Rev. 2.0 compatible PC or peripherals is recommended.
- Devices connected to the USB port (upstream and downstream) work when the monitor is in power saving mode or when the power button of the monitor is Off. Therefore, power consumption of the monitor varies with connected devices even in the power saving mode.
- When the main power switch is Off, device connected to the USB port will not operate.
- The followings are procedures for the Windows 2000/XP/Vista and Mac OS.

### Connecting to the USB HUB

- 1** Connect the monitor to the PC with the signal cable first, then turn on the PC.
- 2** Connect the upstream port of the monitor to the downstream port of the USB compliant PC or another hub by using the USB cable.  
After connecting the USB cable, the USB function can be set up automatically.
- 3** After setting up, the monitor's USB hub is available for connecting USB compliant peripherals to the downstream ports of the monitor

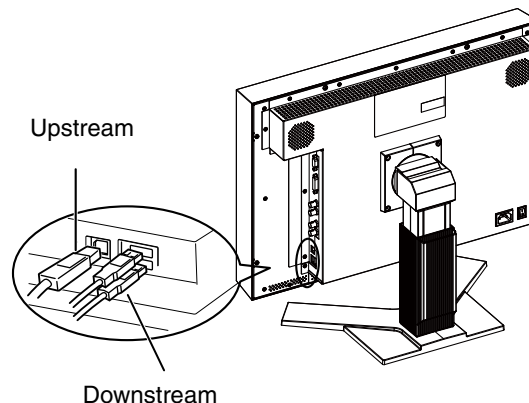

## 5-4. Specifications

LCD Panel	Size	57 cm (22.5 inch)
	Surface treatment	Hard Coating
	Surface hardness	2H
	Response Time	Approx. 12 ms
	Viewing Angle	Horizontal : 176°, Vertical : 176°(CR: 10 or more)
	Dot Pitch	0.252 mm
Horizontal Scan Frequency	Analog	26 - 92kHz
	Digital	26 - 78kHz
Vertical Scan Frequency	Analog	23.8 - 86Hz
	Digital	23.8 - 61Hz (VGA TEXT : 69 - 71Hz)
Resolution		1920 dots x 1200 lines
Dot Clock (Max.)	Analog	162MHz
	Digital	162MHz
Display Colors		1073.74 million colors
Recommended Brightness		100 cd/m <sup>2</sup> or less (with color temperature of between 5000K to 6500K)
Display Area		483.84 mm (H) × 302.4 mm (V) (19" (H) × 11.9" (V))
Power Supply		100-120/200-240 VAC±10%, 50/60 Hz, 1.1 A/0.55A
Power Consumption <sup>1</sup>	Screen Display On	110 W (with USB load) 100 W (without USB load)
	Power Saving Mode	7 W or less (for single signal input, without USB load)
	Power Button off	1 W or less (without USB load)
	Main Power switch off	0 W
Input Signal Connector		D-Sub mini 15-pin x 1 DVI-D connector (Applicable to HDCP) x 1 BNC connector (HD/SD-SDI) x 2 complies to IEC60169-8, 75 Ω
Output Signal Connector		BNC connector (Loop-through) x 2
Analog Input Signal (Sync)		Separate, TTL, Positive/Negative
		Composite, TTL, Positive/Negative
Analog Input Signal (Video)		0.7 Vp-p / 75 ohms, Positive
Input Signal (Digital) (DVI)		TMDS (Single Link)
Signal registration	Analog	45 (Factory preset: 9)
	Digital	10 (Factory preset: 0)
Plug & Play		Analog / Digital (DVI-D) : VESA DDC 2B / EDID structure 1.3
Dimensions	with stand	567 mm (W) x 481 ~ 599 mm (H) x 255 mm (D) (22.3" (W) x 18.9" ~ 23.6" (H) x 10" (D))
	without stand	567 mm (W) x 389 mm (H) x 113 mm (D) (22.3" (W) x 15.3" ~ 23.6" (H) x 4.4" (D))
Weight	with stand	Approx. 13.4 kg (29.5 lbs.)
	without stand	Approx. 8.8 kg (19.4 lbs.)
Movable range		Tilt: 40° Up, 0° Down Swivel: 35° Right, 35° Left Adjustable height: 118 mm (4.6 inch)

Environment Conditions	Temperature	Operating: 0°C ~ 35°C (32°F ~ 95°F) Transportation/Storage: -20°C ~ 60°C (-4°F ~ 140°F)
	Humidity	Operating: 30% to 80% R.H. Non-condensing Transportation/Storage: 30% to 80% R.H. Non-condensing
	Pressure	Operating: 700 to 1060 hPa. Transportation/Storage: 200 to 1060 hPa.
USB	standard	USB Specification Revision 2.0
	USB port	Upstream port x 1 Downstream port x 2
	Communication Speed	480 Mbps (high), 12 Mbps (full), 1.5 Mbps (low)
	Power Supply	Downstream: 500 mA for each (max.)

### Main default settings (factory settings)

Brightness	20%	
Smoothing	3	
Temperature	6500K	
Color Mode	Custom	
PowerManager	On	
Screen Size	Enlarged	
Menu Settings	Menu Size	Enlarged
	Menu Off Timer	45 sec
Black Insertion	Off	
Pseudo Interlace	Off	
Range Extension	Off	
SDI Settings	Auto	
Language	English	



Dimensions

unit: mm (inch)

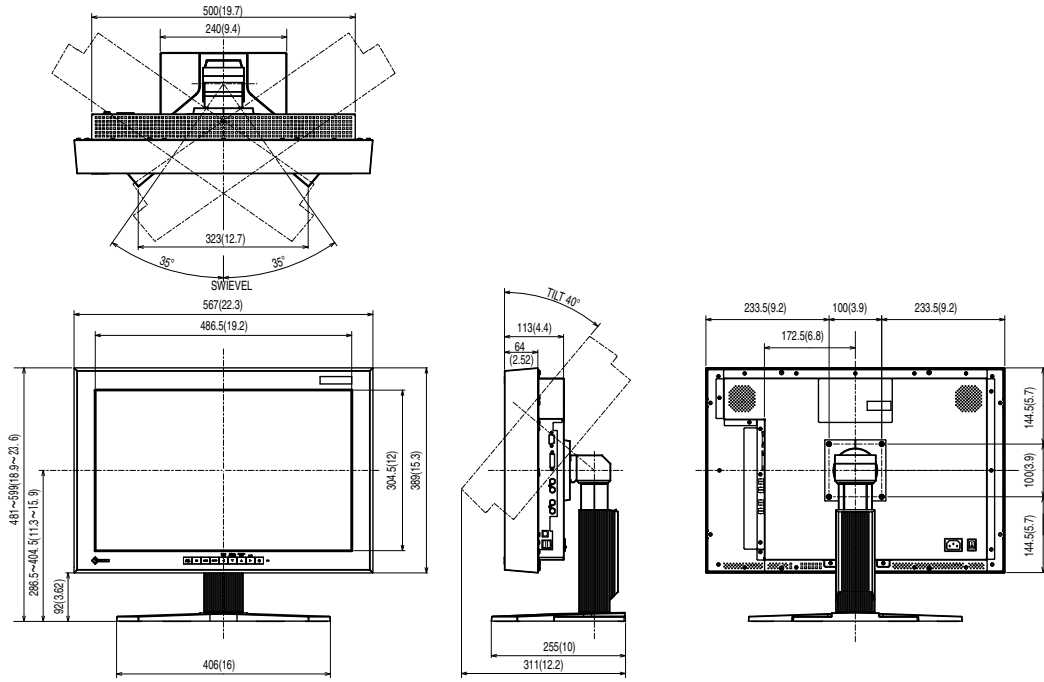

## Pin Assignment

### •DVI-D Connector

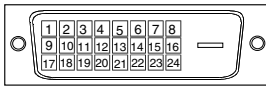

Pin No.	Signal	Pin No.	Signal	Pin No.	Signal
1	T.M.D.S. Data 2-	9	T.M.D.S. Data1-	17	T.M.D.S. Data0-
2	T.M.D.S. Data 2+	10	T.M.D.S. Data1+	18	T.M.D.S. Data0+
3	T.M.D.S. Data2/4 Shield	11	T.M.D.S. Data1/3 Shield	19	T.M.D.S. Data0/5 Shield
4	NC*	12	NC*	20	NC*
5	NC*	13	NC*	21	NC*
6	DDC Clock (SCL)	14	+5V Power	22	T.M.D.S. Clock shield
7	DDC Data (SDA)	15	Ground (return for +5V, Hsync, and Vsync)	23	T.M.D.S. Clock+
8	NC*	16	Hot Plug Detect	24	T.M.D.S. Clock-

(NC\*: No Connection)

### •D-Sub mini 15-pin connector

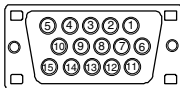

Pin No.	Signal	Pin No.	Signal	Pin No.	Signal
1	Red video	6	Red video ground	11	NC*
2	Green video	7	Green video ground	12	Data (SDA)
3	Blue video	8	Blue video ground	13	H.Sync
4	NC*	9	NC*	14	V.Sync
5	Ground	10	Ground	15	Clock (SCL)

(NC\*: No Connection)

### •USB Port

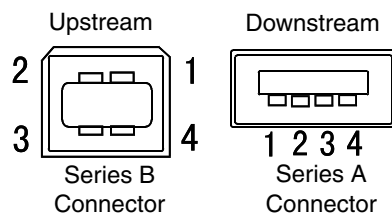

No.	Signal	Remarks
1	VCC	Cable power
2	- Data	Serial data
3	+ Data	Serial data
4	Ground	Cable Ground

---

## 5-5. Glossary

---

### **Clock**

With the analog input signal display, the analog signal is converted to a digital signal by the LCD circuitry. To convert the signal correctly, the LCD monitor needs to produce the same number clock pulse as the dot clock of the graphics system. When the clock pulse is not correctly set, some vertical bars of distortion are displayed on the screen.

### **DVI (Digital Visual Interface)**

A digital flat panel interface. DVI can transmit digital data from the PC directly without loss with the signal transition method "TMDS". There are two kinds of DVI connectors. One is DVI-D connector for digital signal input only. The other is DVI-I connector for both digital and analog signal inputs.

### **DVI DMPM (DVI Digital Monitor Power Management)**

The Power management system for the digital interface. The "Monitor ON" status (operation mode) and the "Active Off" status (power-saving mode) are indispensable for the DVI-DMPM as the monitor's power mode.

### **Gain Adjustment**

Adjusts each color parameter for red, green and blue. The color of the LCD monitor is displayed through the color filter of the LCD panel. Red, green and blue are the three primary colors. The colors on the monitor are displayed by combining these three colors. The color tone can change by adjusting the illumination amount passed through each color's filter.

### **Gamma**

Generally, the relationship that the light intensity values of a monitor change nonlinearly to the input signal level is called "Gamma Characteristic". On the monitor, low gamma values display the whitish images and high gamma values display the high contrast images.

### **HDCP (High-bandwidth Digital Contents Protection)**

Digital signal coding system developed to copy-protect the digital contents, such as video, music, etc. This helps to transmit the digital contents safely by coding the digital contents sent via DVI terminal on the output side and decoding them on the input side.

Any digital contents cannot be reproduced if both of the equipments on the output and input sides are not applicable to HDCP system.

### **Phase**

The phase adjustment decides the sampling timing point for converting the analog input signal to a digital signal. Adjusting the phase after the clock adjustment will produce a clear screen.

### **Range Adjustment**

The Range Adjustment controls the level of output signal range to display the whole color gradation.

## **Resolution**

The LCD panel consists of a fixed number of pixel elements which are illuminated to form the screen image. The display panel of this monitor consists of 1920 horizontal pixels and 1200 vertical pixels. At a resolution of 1920 x 1200 , images are displayed as a full screen(1:1).

## **SDI (Serial Digital Interface)**

One of the interfaces standardized by the SMPTE and ARIB. It transmits image signals, sync signal, clock, and audio signals all on one cable.

## **sRGB (Standard RGB)**

“International Standard for Red, Green, and Blue color space” A color space was defined with the aim of the color matching between applications and hardware devices, such as monitors, scanners, printers and digital cameras. As a standard default space, sRGB allows Internet users to closely match colors.

## **Temperature**

Color Temperature is a method to measure the white color tone, generally indicated in degrees Kelvin. At high temperatures the white tone appears somewhat blue, while at lower temperatures it appears somewhat red. Computer monitors generally give best performance at high temperature settings.

5000 K: Slightly reddish white (usually used in print industry)

6500 K: White called daylight color (suited for web browsing)

9300 K: Slightly bluish white (usually used for television)

## **TMDS (Transition Minimized Differential Signaling)**

A signal transition method for the digital interface.

## **VESA DPM**

### **(Video Electronics Standards Association - Display Power Management)**

VESA specifications achieve increased energy efficiency for computer monitors. This involves standardization of signals sent from the computer (graphics board).DPM defines the status of signals transmitted between the computer and monitor.

## 6. Preset Timing

The following table shows factory preset video timing (for analog signal only).

### Note

- Display position may be deviated depending on the PC connected, which may require screen adjustment using Adjustment menu.
- If a signal other than those listed in the table is input, adjust the screen using the Adjustment menu. However, screen display may still be incorrect even after the adjustment.
- When interlace signals are used, the screen cannot be displayed correctly even after screen adjustment using the Adjustment menu.

Mode	Dot clock		Frequency		Polarity
			Horizontal: kHz	Vertical: Hz	
VGA 640×480@60Hz	28.3MHz	Horizontal	31.47		Negative
		Vertical	59.94		Negative
VGA TEXT 720×400@70Hz	28.3 MHz	Horizontal	31.47		Negative
		Vertical	70.09		Positive
VESA 800×600@60Hz	40.0 MHz	Horizontal	37.88		Positive
		Vertical	60.32		Positive
VESA 1024×768@60Hz	65.0 MHz	Horizontal	48.36		Negative
		Vertical	60.00		Negative
VESA 1280×960@60Hz	108.0 MHz	Horizontal	60.00		Positive
		Vertical	60.00		Positive
VESA 1280×1024@60Hz	108.0 MHz	Horizontal	63.98		Positive
		Vertical	60.02		Positive
VESA 1600×1200@60Hz	162.0MHz	Horizontal	75.00		Positive
		Vertical	60.00		Positive
VESA CVT 1680×1050 60Hz	146.3 MHz	Horizontal	65.29		Negative
		Vertical	59.95		Positive
VESA CVT 1920×1200 60Hz	154.00MHz	Horizontal	74.04		Positive
		Vertical	59.95		Negative

### For U.S.A, Canada, etc. (rated 100-120 Vac) Only

This equipment has been tested and found to comply with the limits for a Class A digital device, pursuant to Part 15 of the FCC Rules. These limits are designed to provide reasonable protection against harmful interference when the equipment is operated in a commercial environment. This equipment generates, uses, and can radiate radio frequency energy and if not installed and used in accordance with the instruction manual, may cause harmful interference to radio communications. Operation of this equipment in a residential area is likely to cause harmful interference in which case the user will be required to correct the interference at his own expense.

Changes or modifications not expressly approved by the party responsible for compliance could void the user's authority to operate the equipment.

#### **Note**

Use the attached specified cable below or EIZO signal cable with this monitor so as to keep interference within the limits of a Class A digital device.

- AC Cord
- Shielded Signal Cable (enclosed)

### Canadian Notice

This Class A digital apparatus complies with Canadian ICES-003.

Cet appareil numérique de la classe A est conforme à la norme NMB-003 du Canada.

### For Europe, etc. (rated 200-240 Vac) Only

#### **Warning**

This is a Class A product. In a domestic environment this product may cause radio interference in which case the user may be required to take adequate measures.

#### **Warnung**

Bei dem Gerät handelt es sich um ein Klasse-A-Produkt. Bei Betrieb des Geräts in Wohnumgebungen ist gegebenenfalls durch entsprechende Maßnahmen dafür zu sorgen, dass eine Störung des Radio- und Fernsehempfangs vermieden wird.

#### **Avertissement**

Cet appareil est de classe A. Il est susceptible de créer des interférences radio dans un environnement domestique, dans ce cas l'utilisateur devra prendre les mesures appropriées.

### **Hinweise zur Auswahl des richtigen Schwenkarms für Ihren Monitor**

Dieser Monitor ist für Bildschirmarbeitsplätze vorgesehen. Wenn nicht der zum Standardzubehör gehörige Schwenkarm verwendet wird, muss statt dessen ein geeigneter anderer Schwenkarm installiert werden. Bei der Auswahl des Schwenkarms sind die nachstehenden Hinweise zu berücksichtigen:

Der Standfuß muß den nachfolgenden Anforderungen entsprechen:

- a) Der Standfuß muß eine ausreichende mechanische Stabilität zur Aufnahme des Gewichtes vom Bildschirmgerät und des spezifizierten Zubehörs besitzen. Das Gewicht des Bildschirmgerätes und des Zubehörs sind in der zugehörigen Bedienungsanleitung angegeben.
- b) Die Befestigung des Standfusses muß derart erfolgen, daß die oberste Zeile der Bildschirmanzeige nicht höher als die Augenhöhe eines Benutzers in sitzender Position ist.
- c) Im Fall eines stehenden Benutzers muß die Befestigung des Bildschirmgerätes derart erfolgen, daß die Höhe der Bildschirmmitte über dem Boden zwischen 135 – 150 cm beträgt.
- d) Der Standfuß muß die Möglichkeit zur Neigung des Bildschirmgerätes besitzen (max. vorwärts: 5°, min. nach hinten  $\geq 5^\circ$ ).
- e) Der Standfuß muß die Möglichkeit zur Drehung des Bildschirmgerätes besitzen (max.  $\pm 180^\circ$ ). Der maximale Kraftaufwand dafür muß weniger als 100 N betragen.
- f) Der Standfuß muß in der Stellung verharren, in die er manuell bewegt wurde.
- g) Der Glanzgrad des Standfusses muß weniger als 20 Glanzeinheiten betragen (seidenmatt).
- h) Der Standfuß mit Bildschirmgerät muß bei einer Neigung von bis zu 10° aus der normalen aufrechten Position kippstabil sein.

### **Hinweis zur Ergonomie :**

Dieser Monitor erfüllt die Anforderungen an die Ergonomie nach EK1-ITB2000 mit dem Videosignal, 1920×1200, Digital Eingang und mindestens 60,0 Hz Bildwiederholfrequenz, non interlaced. Weiterhin wird aus ergonomischen Gründen empfohlen, die Grundfarbe Blau nicht auf dunklem Untergrund zu verwenden (schlechte Erkennbarkeit, Augenbelastung bei zu geringem Zeichenkontrast.)

„Maschinenlärminformations-Verordnung 3. GPSGV:

Der höchste Schalldruckpegel beträgt 70 dB(A) oder weniger gemäss EN ISO 7779“

