

# Installation Manual

## RadiForce® MX315W

Color LCD Monitor

### Important

Please read this “Installation Manual”, and “Instructions for Use” (separate volume) carefully to familiarize yourself with safe and effective usage.

- 
- Refer to the “Instructions for Use” for information on the installation / connection of the monitor.
  - For the latest product information including the “Installation Manual”, refer to our web site :  
<http://www.eizoglobal.com>
- 



This product has been adjusted specifically for use in the region to which it was originally shipped. If operated outside this region, the product may not perform as stated in the specifications.

---

No part of this manual may be reproduced, stored in a retrieval system, or transmitted, in any form or by any means, electronic, mechanical, or otherwise, without the prior written permission of EIZO Corporation. EIZO Corporation is under no obligation to hold any submitted material or information confidential unless prior arrangements are made pursuant to EIZO Corporation's receipt of said information. Although every effort has been made to ensure that this manual provides up-to-date information, please note that EIZO monitor specifications are subject to change without notice.

---

# CONTENTS

<b>CONTENTS</b> .....	<b>3</b>	<b>Chapter 5 Configuring Monitor Settings</b> .....	<b>22</b>
<b>Chapter 1 Basic Operation and Function List</b> ... 4		5-1. Specifying the Language.....	22
1-1. Usage of Switches and Operation Guide... 4		5-2. Showing the Icon for Switching the USB Ports in the Operation Guide .....	22
1-2. Basic Operation of the Setting Menu .....	6	5-3. Switching PCs Used to Operate USB Devices.....	22
1-3. Function List.....	8	5-4. Setting the Signal Format of DisplayPort 1 ... 23	
<b>Chapter 2 Adjusting the Screen</b> .....	<b>9</b>	● Switching the DisplayPort 1 version .....	23
2-1. Compatible Resolutions .....	9	● Enabling or disabling daisy-chain connection.....	23
2-2. Setting Screen Layout (Single / Dual) and Input Signal .....	9	5-5. Adjusting Brightness of the Power Switch Indicator .....	24
2-3. Displaying the Sub Window (PinP) .....	10	5-6. Skipping Unused Display Modes .....	24
● Showing the icon for displaying / hiding the PinP sub window in the operation guide... 10		5-7. Enabling or Disabling DisplayPort Communication in Power Saving Mode ...	24
● Displaying or hiding the PinP sub window .....	11	5-8. Locking Operation Switches .....	25
● Setting the input signal for the PinP sub window .....	11	5-9. Selecting the Input Signal for DDC Communication.....	25
● Setting the display position of the PinP sub window.....	11	5-10. Setting Whether to Display / Hide the Grayscale Warning .....	25
● Setting display mode (CAL Switch Mode) for the PinP sub window .....	11	5-11. Acquiring Life Estimation Data .....	26
2-4. Selecting Display Mode (CAL Switch Mode) .....	12	5-12. Rotating the Setting Menu Display .....	26
2-5. Adjusting Brightness / Colors.....	13	5-13. Setting Whether to Display / Hide the EIZO Logo .....	26
● Adjustment items for each mode .....	13	5-14. Viewing the Monitor Information .....	27
● Adjusting the brightness.....	13	5-15. Resetting to Defaults.....	27
● Adjusting the contrast .....	14	● Resetting the color adjustment value.....	27
● Adjusting the color temperature.....	14	● Resetting all settings.....	27
● Adjusting the gamma .....	15	<b>Chapter 6 Troubleshooting</b> .....	<b>28</b>
● Adjusting the hue .....	15	6-1. No Picture .....	28
● Adjusting the color saturation.....	15	6-2. Imaging Problems.....	29
● Adjusting the gain.....	16	6-3. Other Problems .....	30
2-6. Enabling or Disabling Sharpness Recovery (the Function of Correcting Image Clarity) .....	16	● Error Code Table.....	31
<b>Chapter 3 Controlling Monitor Quality</b> .....	<b>17</b>	<b>Chapter 7 Reference</b> .....	<b>32</b>
3-1. Using the SelfCalibration Function .....	17	7-1. Arm Installation Procedure.....	32
● Executing SelfCalibration.....	17	7-2. How to Use USB Hub Function.....	33
● Checking the SelfCalibration results.....	18	7-3. Main Default Settings .....	34
3-2. Using the Grayscale Check Function .....	18	<b>Appendix</b> .....	<b>35</b>
● Performing Grayscale Check.....	18	Trademark .....	35
● Checking the Grayscale Check results.....	19	License .....	35
3-3. Setting Whether to Display / Hide Warnings or QC History .....	19	LIMITED WARRANTY .....	36
<b>Chapter 4 Using the Monitor for a Long Time</b> ...	<b>20</b>	<b>Recycling Information</b> .....	<b>37</b>
4-1. Setting the Power Saving Mode .....	20		
4-2. Setting Power Saving Mode That Is Activated When the User Moves Away.....	21		

# Chapter 1 Basic Operation and Function List







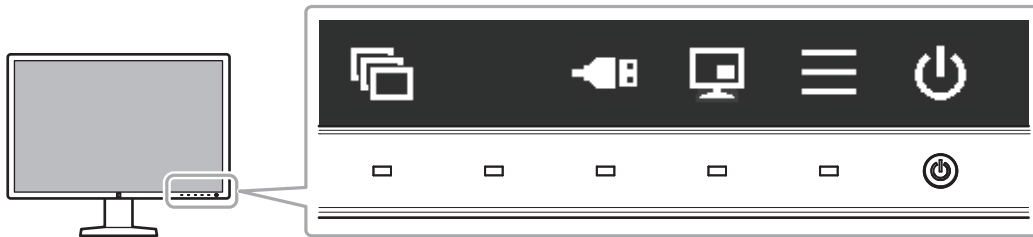

## 1-1. Usage of Switches and Operation Guide

### 1. Displaying the operation guide

Touch any switch (except ).

The operation guide appears on the screen.



Display	Function
	Turns the power on or off.
	Displays the Setting menu. The Setting menu is used to configure advanced monitor settings.
	Displays or hides the PinP sub window. <b>Attention</b> • The operation guide does not display this item by default. See <a href="#">“Showing the icon for displaying / hiding the PinP sub window in the operation guide”</a> (page 10) for information on how to display.
	Switches PCs used to operate USB devices. For more information about how to switch PCs, see <a href="#">“5-3. Switching PCs Used to Operate USB Devices”</a> (page 22). <b>Attention</b> • The operation guide does not display this item by default. See <a href="#">“5-2. Showing the Icon for Switching the USB Ports in the Operation Guide”</a> (page 22) for information on how to display.
	Switches display modes. For more information about how to switch display modes, see <a href="#">“2-4. Selecting Display Mode (CAL Switch Mode)”</a> (page 12).
	Selects an item.
	Applies the selected content.
	Cancels the selection.

## 2. Adjusting / setting

1. Touch a switch for the icon showing the item you want to set.  
The menu appears.
2. Use each switch to configure the setting. If necessary, select  to apply the setting.

## 3. Exiting

Select  to exit the menu.

---

**Note**

- The operation guide will automatically disappear after a few seconds if no switches are operated.
-

## 1-2. Basic Operation of the Setting Menu



### 1. Displaying the Setting menu

1. Select  from the operation guide.



The Setting menu appears.



#### Note



- To adjust or set "Administrator Settings" items, display the Setting menu according to the following procedure:
  1. Select  to turn off the monitor.
  2. While touching the leftmost switch (  ), touch  for more than two seconds to turn on the monitor. "Administrator Settings" appears.

### 2. Adjusting / setting

1. Select a menu to adjust / set using  , then select .



The advanced menu appears.

2. Select an item to adjust / set using  , then select .

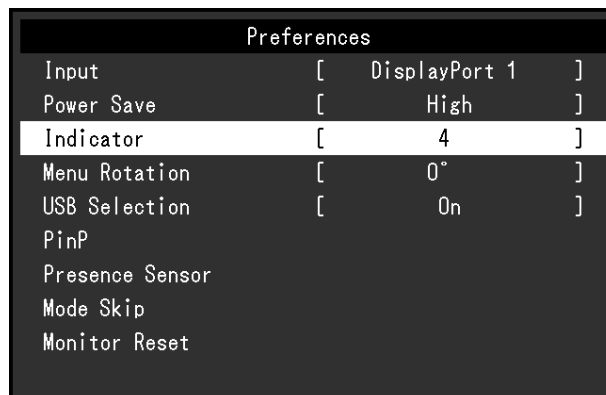

The Adjustment / Setting menu appears.

3. Adjust / set the selected item using **<** **>** , and then select **✓**.



---

**Note**

- The settings for "Administrator Settings" items are applied by selecting "Apply".



---

### 3. Exiting

Select **✕** several times to exit the Setting menu.

---

**Note**

- The menu for "Administrator Settings" items is exited by selecting "Apply".
-

## 1-3. Function List

The following table shows the items in the Setting menu.

Main menu	Item	Reference
CAL Switch Mode	Mode	<a href="#">"2-5. Adjusting Brightness / Colors" (page 13)</a>  <b>Note</b> • The functions that can be adjusted or set in "CAL Switch Mode" differ depending on the mode (see <a href="#">"Adjustment items for each mode" (page 13)</a> ).
	Brightness	
	Contrast	
	Temperature	
	Gamma	
	Hue	
	Saturation	
	Gain	
Reset		
RadiCS SelfQC	SelfCalibration	<a href="#">"3-1. Using the SelfCalibration Function" (page 17)</a>
	Grayscale Check	<a href="#">"3-2. Using the Grayscale Check Function" (page 18)</a>
	LEA	<a href="#">"5-11. Acquiring Life Estimation Data" (page 26)</a>
	Settings	<a href="#">"3-3. Setting Whether to Display / Hide Warnings or QC History" (page 19)</a>
Preferences	Input	<a href="#">"2-2. Setting Screen Layout (Single / Dual) and Input Signal" (page 9)</a>
	Power Save	<a href="#">"4-1. Setting the Power Saving Mode" (page 20)</a>
	Indicator	<a href="#">"5-5. Adjusting Brightness of the Power Switch Indicator" (page 24)</a>
	Menu Rotation	<a href="#">"5-12. Rotating the Setting Menu Display" (page 26)</a>
	USB Selection	<a href="#">"5-2. Showing the Icon for Switching the USB Ports in the Operation Guide" (page 22)</a>
	PinP	<a href="#">"2-3. Displaying the Sub Window (PinP)" (page 10)</a>
	Presence Sensor	<a href="#">"4-2. Setting Power Saving Mode That Is Activated When the User Moves Away" (page 21)</a>
	Mode Skip	<a href="#">"5-6. Skipping Unused Display Modes" (page 24)</a>
Monitor Reset	<a href="#">"5-15. Resetting to Defaults" (page 27)</a>	
Languages		<a href="#">"5-1. Specifying the Language" (page 22)</a>
Information		<a href="#">"5-14. Viewing the Monitor Information" (page 27)</a>
Administrator Settings	On-Screen Logo	<a href="#">"5-13. Setting Whether to Display / Hide the EIZO Logo" (page 26)</a>
	Key Lock	<a href="#">"5-8. Locking Operation Switches" (page 25)</a>
	DDC	<a href="#">"5-9. Selecting the Input Signal for DDC Communication" (page 25)</a>
	DP Power Save	<a href="#">"5-7. Enabling or Disabling DisplayPort Communication in Power Saving Mode" (page 24)</a>
	Grayscale Warning	<a href="#">"5-10. Setting Whether to Display / Hide the Grayscale Warning" (page 25)</a>
	Sharpness Recovery	<a href="#">"2-6. Enabling or Disabling Sharpness Recovery (the Function of Correcting Image Clarity)" (page 16)</a>
	Signal Format	<a href="#">"5-4. Setting the Signal Format of DisplayPort 1" (page 23)</a>



# Chapter 2 Adjusting the Screen

## 2-1. Compatible Resolutions

For information about the compatible resolutions of the monitor, see "Compatible Resolutions" in the Instructions for Use. For information on how to set the resolution on a PC, refer to the manual of the PC.

## 2-2. Setting Screen Layout (Single / Dual) and Input Signal

You can select single screen or dual screen (PbyP) mode, as well as the input signal.

### Procedure

1. Select "Preferences" from the Setting menu, then select .
2. Select "Input", then .
3. Select a signal or combination of signals to be displayed from "DisplayPort 1", "DVI", "DisplayPort 1 / DisplayPort 2", and "DisplayPort 1 / DVI", then select .

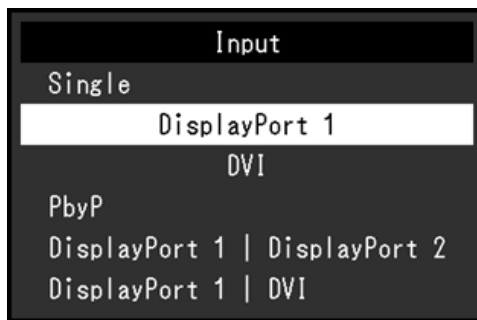

In PbyP mode, the "DisplayPort 1" input signal is shown on the left side of the screen, and the "DisplayPort 2" or "DVI" input signal is shown on the right.

Example of DisplayPort 1 / DisplayPort 2:

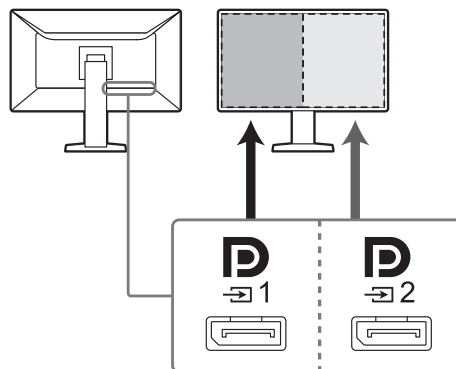

### Note

- When the setting is complete, the input port names appear.

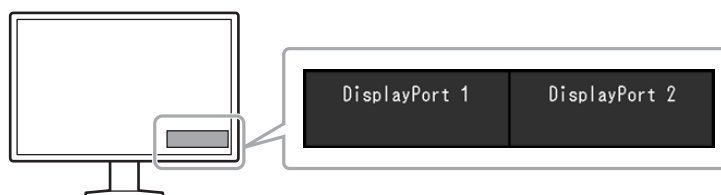

## 2-3. Displaying the Sub Window (PinP)

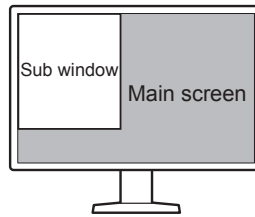

### Note

- When the main screen displays the "DisplayPort 1" signal in single screen mode, the PinP sub window displays the "DisplayPort 2" or "DVI" signal. Select a signal to be displayed on the PinP sub window. For more information about how to select a signal, see ["Setting the input signal for the PinP sub window"](#) (page 11).
- When the main screen is in PbyP mode, the PinP sub window displays a signal that is not shown on the main screen.
- Resolutions supported for the PinP sub window are as follows. The PinP sub window displays images in 8-bits.

√: Supported

Resolution (H x V)	Vertical frequency (Hz)	DisplayPort	DVI
720 × 400	70	√	√
640 × 480	60	√	√
800 × 600	60	√	√
1024 × 768	60	√	√
1280 × 1024	60	√	√
1600 × 1200	60	√	√
1920 × 1200	60	√	√
1200 × 1600	60	√	√
1200 × 1920	60	√	√

### Attention

- When the main screen displays the "DVI" signal in single screen mode, the PinP sub window is not available.
- The PinP sub window is not available in the following cases:
  - No signal is input.
  - A signal that is not supported is input.

## ● Showing the icon for displaying / hiding the PinP sub window in the operation guide

You can specify whether to display  in the operation guide.



### Procedure

1. Select "Preferences" from the Setting menu, then select .
2. Select "PinP", then .
3. Select "PinP Display", then .
4. Select "On" or "Off" using  or , then select .

## ● Displaying or hiding the PinP sub window

You can select whether to display or hide the PinP sub window.

### **Procedure**

1. Touch any switch (except ).
2. Select  from the operation guide.  
The PinP sub window is displayed or hidden.

---





### **Note**

- By using RadiCS / RadiCS LE, you can display or hide the PinP sub window more easily using the mouse or keyboard (Hide-and-Seek). Refer to RadiCS / RadiCS LE User's Manual for details.
- 

## ● Setting the input signal for the PinP sub window

Select a signal to be displayed on the PinP sub window when the main screen displays the "DisplayPort 1" signal in single screen mode.





### **Procedure**

1. Select "Preferences" from the Setting menu, then select .
2. Select "PinP", then .
3. Select "Input", then .
4. Select "DisplayPort 2" or "DVI", then .

## ● Setting the display position of the PinP sub window

You can set the display position of the PinP sub window.





### **Procedure**

1. Select "Preferences" from the Setting menu, then select .
2. Select "PinP", then .
3. Select "Position" then .
4. Select "Upper Right", "Lower Right", "Lower Left", or "Upper Left", then select .

## ● Setting display mode (CAL Switch Mode) for the PinP sub window

You can specify the display mode for the PinP sub window.

### **Procedure**

1. Select "Preferences" from the Setting menu, then select .
2. Select "PinP", then .
3. Select "CAL Switch Mode", then .
4. Select a display mode, then .

---

### **Attention**

- Medical images must be shown on the PinP main screen. We recommend that the sub window be used to display text, etc.
-

## 2-4. Selecting Display Mode (CAL Switch Mode)



The display mode can be selected according to the monitor application. For information on how to specify the display mode for the PinP sub window, see “Setting display mode (CAL Switch Mode) for the PinP sub window” (page 11).

### Display Modes

√: Can be calibrated



Mode	Purpose	
1-DICOM	Enables display using DICOM Part 14-compliant grayscale characteristics.	√
2-CAL1	Displays the calibration status using calibration software.	√
3-CAL2		√
4-Custom	Select this mode to configure desired settings.	-
5-sRGB	Suitable for color matching with sRGB compatible peripherals.	-
6-Text	Suitable to display documents, spreadsheets, or other text.	-

### Procedure

1. Touch any switch (except ).
2. Select  from the operation guide.  
The Mode menu appears on the lower right.

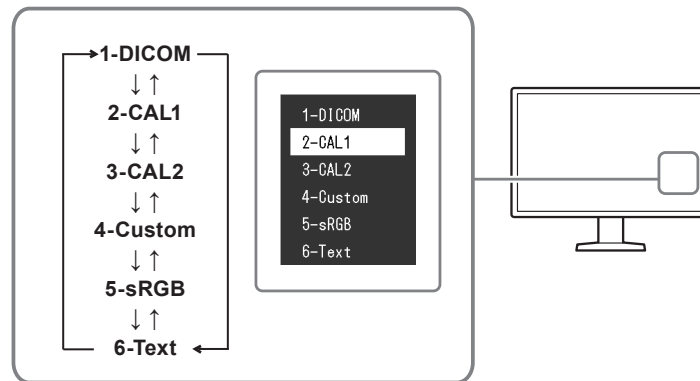
Example:



3. Modes are changed in sequence each time you select .  
You can also select  or  to change modes when the Mode menu is being displayed.

#### Note

- The Setting menu and Mode menu cannot be displayed at the same time.

## 2-5. Adjusting Brightness / Colors

You can adjust brightness and colors for each mode, and save the settings.

### Attention

- It takes about 15 minutes for the electrical parts in the product to become stable. Please wait 15 minutes or more after the monitor power has been turned on or the monitor has recovered from the power saving mode before performing adjustment.
- The same image may be observed in different colors on multiple monitors due to monitor-specific characteristics. Make fine color adjustment visually when matching colors on multiple monitors.

### Note

- Use a value shown in "%" or "K" only for reference.

### ● Adjustment items for each mode

Adjustable functions differ depending on the mode type. (Functions that cannot be adjusted or set are not selectable.)

√: Adjustable -: Not adjustable

Function	CAL Switch Mode					
	1-DICOM	2-CAL1	3-CAL2	4-Custom	5-sRGB	6-Text
Brightness	√	√	√	√	√	√
Contrast	-	-	-	√	√	√
Temperature	-	-	-	√	√	√
Gamma	-	-	-	√	√	√
Hue	-	-	-	√	√	√
Saturation	-	-	-	√	√	√
Gain	-	-	-	√	√	√
Reset	√	√	√	√	√	√

### ● Adjusting the brightness

The screen brightness is adjusted by changing the brightness of the backlight (light source from the LCD back panel).

#### Setting Range

0 to 100 %

#### Procedure

1. Select "CAL Switch Mode" from the Setting menu, then select .
2. Select "Brightness", then .
3. Specify the setting using  or .
4. Select  after completing the setting.

## ● Adjusting the contrast

The brightness of the screen is adjusted by varying the video signal level.

### **Setting Range**

0 to 100 %

### **Procedure**

1. Select "CAL Switch Mode" from the Setting menu, then select .
2. Select "Contrast", then .
3. Specify the setting using  or .
4. Select  after completing the setting.

---

#### **Note**

- When the contrast is set to 100 %, all the color gradations are shown.
  - When adjusting the monitor, it is recommended to perform brightness adjustment, which does not lose gradation characteristics, prior to contrast adjustment.
  - Perform contrast adjustment in the following cases.
    - If the screen is too bright even when the brightness is set to 0 %
- 

## ● Adjusting the color temperature

Adjust the color temperature.

The color temperature is normally used to express the hue of "White" and / or "Black" with a numerical value. The value is expressed in degrees "K" (Kelvin).

The screen becomes reddish at low color temperatures and bluish at high color temperatures, similar to the temperatures of a flame. The gain preset values are set for each color temperature setting value.

### **Setting Range**

Native, 6000 K to 15000 K (in increments of 100 K), sRGB

### **Procedure**

1. Select "CAL Switch Mode" from the Setting menu, then select .
2. Select "Temperature" then .
3. Specify the setting using  or .
4. Select  after completing the setting.

---

#### **Note**

- "Gain" allows you to perform more advanced adjustment (see ["Adjusting the gain" \(page 16\)](#)).
  - If set to "Native", the image is displayed in the preset color of the monitor (Gain: 100 % for each RGB channel).
  - When gain is changed, the color temperature is changed to "User".
-

## ● Adjusting the gamma

Adjust the gamma. While the brightness of the monitor varies depending on the input signal, the variation rate is not proportional to the input signal. Maintaining the balance between the input signal and brightness of the monitor is referred to as "Gamma correction".

### **Setting Range**

1.6 to 2.7, sRGB

### **Procedure**

1. Select "CAL Switch Mode" from the Setting menu, then select .
2. Select "Gamma", then .
3. Specify the setting using  or .
4. Select  after completing the setting.

## ● Adjusting the hue

Adjust the hue.

### **Setting Range**

-100 to 100

### **Procedure**

1. Select "CAL Switch Mode" from the Setting menu, then select .
2. Select "Hue", then .
3. Specify the setting using  or .
4. Select  after completing the setting.

---

#### **Attention**

- Using this function may prevent some color gradations from being able to be displayed.
- 

## ● Adjusting the color saturation

Adjust the color saturation.

### **Setting Range**

-100 to 100

### **Procedure**

1. Select "CAL Switch Mode" from the Setting menu, then select .
2. Select "Saturation", then .
3. Specify the setting using  or .
4. Select  after completing the setting.

---

#### **Attention**

- Using this function may prevent some color gradations from being able to be displayed.
- 

#### **Note**

- The minimum value (-100) changes the screen to monochrome.
-







## ● Adjusting the gain

The brightness of each color component (red, green, and blue) is called "gain". The hue of "white" can be changed by adjusting the gain.

### **Setting Range**

0 to 100 %

### **Procedure**

1. Select "CAL Switch Mode" from the Setting menu, then select .
2. Select "Gain", then .
3. Select the color to be adjusted from "Red", "Green", and "Blue", then select .
4. Specify the setting using  or .
5. Select  after completing the setting.

---

### **Attention**

- Using this function may prevent some color gradations from being able to be displayed.

### **Note**









- The gain value changes according to the color temperature.
  - When gain is changed, the color temperature is changed to "User".
- 

## 2-6. Enabling or Disabling Sharpness Recovery (the Function of Correcting Image Clarity)

---

EIZO's unique technology called "Sharpness Recovery" displays images that are true to the original source data by correcting variations in the LCD panel.

### **Procedure**

1. Select  to turn off the monitor.
2. While touching the leftmost switch (  ), touch  for more than two seconds to turn on the monitor.
3. Select "Sharpness Recovery" in "Administrator Settings", then select .
4. Select "On" or "Off" using  or , then select .
5. Select "Apply", and then select .

---

### **Attention**

- After changing the setting, perform a visual check according to the medical standards / guidelines.
-



# Chapter 3 Controlling Monitor Quality

The monitor includes the Integrated Front Sensor, which enables you to perform calibration and Grayscale Check independently.

### Note

- Calibration can be performed periodically by using the schedule function of RadiCS LE that is attached to the monitor. For more information about the setup procedure, refer to the RadiCS LE User's Manual (stored on the CD-ROM).
- RadiCS enables you to configure the schedule settings for Grayscale Check as well as for calibration. For more information about the setup procedure, refer to the RadiCS User's Manual.
- If you want to perform high-level quality control in compliance with medical standards / guidelines, use optional quality control software kit "RadiCS UX1".
- Perform correlation using RadiCS / RadiCS LE to adjust the measurement results of the Integrated Front Sensor to those of the EIZO UX1 sensor for reference. Periodical correlation enables the measurement accuracy of the Integrated Front Sensor equivalent to that of the UX1 sensor. For details, refer to the RadiCS / RadiCS LE User's Manual.

## 3-1. Using the SelfCalibration Function

Execute SelfCalibration and view the latest results.

### ● Executing SelfCalibration

#### Procedure

1. Select "RadiCS SelfQC" from the Setting menu, then select .
  2. Select "SelfCalibration" for "RadiCS SelfQC", then select .
  3. Select "Execute", then .
- SelfCalibration is executed.

#### Attention

- If the power to the PC is turned off or the input signal switches while SelfCalibration is running, the execution will be canceled.
- After SelfCalibration is complete, perform Grayscale Check at the same room temperature and illuminance as those in the actual working environment.

#### Note

- The following items can be set by using RadiCS / RadiCS LE. For more information about the setup procedure, refer to the RadiCS / RadiCS LE User's Manual.
  - Calibration target
  - SelfCalibration schedule
  - If you have configured the schedule using RadiCS / RadiCS LE, the next execution schedule is displayed in the advanced menu.

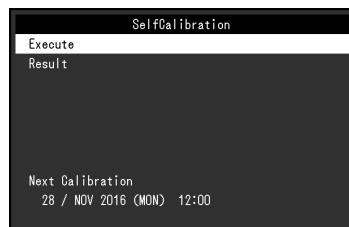

- The calibration target value can be confirmed by selecting the target mode in "CAL Switch mode" of the Setting menu.

## ● Checking the SelfCalibration results

### Attention

- The results can be checked when "QC History" is set to "On" (see "3-3. Setting Whether to Display / Hide Warnings or QC History" (page 19)).

### Procedure

1. Select "RadiCS SelfQC" from the Setting menu, then select .
2. Select "SelfCalibration", then .
3. Select "Result", then .
4. Select "DICOM", "CAL1", or "CAL2", then select .

The SelfCalibration results (such as Max. Error Rate, Last Time, and Error Code) are displayed.

## 3-2. Using the Grayscale Check Function

Perform Grayscale Check and view the latest results. Furthermore, if you have configured the schedule using RadiCS, the next execution schedule is displayed.

## ● Performing Grayscale Check

### Attention

- Perform the Grayscale Check based on the actual color temperature and brightness of the working environment.

### Procedure

1. Select "RadiCS SelfQC" from the Setting menu, then select .
2. Select "Grayscale Check", then .
3. Select "Execute", then .

Grayscale Check is executed.

### Attention

- The determination value for Grayscale Check can be specified from RadiCS. Refer to the RadiCS User's Manual for details.
- The Grayscale Check schedule can be configured using RadiCS. For more information about the setup procedure, refer to the RadiCS User's Manual. If you have configured the schedule using RadiCS, the next execution schedule is displayed in the advanced menu.



## ● Checking the Grayscale Check results

---

**Attention**

- The results can be checked when "QC History" is set to "On".
- 

**Procedure**

1. Select "RadiCS SelfQC" from the Setting menu, then select .
2. Select "Grayscale Check", then .
3. Select "Result", then .
4. Select "DICOM", "CAL1", or "CAL2", then select .

Up to five past Grayscale Check results (Passed, Failed, Canceled, or Error) are displayed.

## 3-3. Setting Whether to Display / Hide Warnings or QC History

---

You can set whether to display or hide warnings related to "Failed" Grayscale Check results, or the execution results (QC History) of SelfCalibration, Grayscale Check, etc.

**Procedure**

1. Select "RadiCS SelfQC" from the Setting menu, then select .
2. Select "Settings", then .
3. Select "Warning" or "QC History".
4. Select "On" or "Off", then select .

# Chapter 4 Using the Monitor for a Long Time

The monitor can be set to enter the power saving mode according to the PC status or the user's movement. The life of the monitor backlight can be extended by setting the monitor to enter the power saving mode when the monitor is not used.

## 4-1. Setting the Power Saving Mode

You can specify whether the monitor enters the power saving mode according to the PC status.

### Procedure

1. Select "Preferences" from the Setting menu, then select .
2. Select "Power Save", then .
3. Select "High", "Low", or "Off" using  or , then select .

Setting	Function
High	Turns the backlight off. This provides the highest power saving effect.
Low	Sets the backlight to the lowest lighting level. The time until operation stabilizes after restoring from power saving mode can be reduced.
Off	Does not enable the power saving mode. The backlight lights up irrespective of the PC status. This setting may shorten the backlight life.

### Attention

- When not using the monitor, you can turn off the main power supply or disconnect the power plug so that the power is cut completely.
- Devices connected to the USB upstream port and downstream port still work when the monitor is in the power saving mode or when the power is switched off using the power button (  ) of the monitor. For this reason, power consumption of the monitor varies with connected devices even in the power saving mode.
- Regardless of whether the PinP sub window is displayed or not, the monitor may not enter the power saving mode when a signal is input to the PinP sub window.

### Note

- When the signal input from the PC is no longer detected, a message appears notifying the user of the transition to the power saving mode. The monitor enters power saving mode five seconds after the message appears.
- You can check the monitor status by viewing the power switch indicator.

PC status	Monitor status	Power indicator
On	Normal operation mode	Green
Power saving mode	Power saving mode	Orange
Power saving mode	Normal operation mode (No input signal)	Green

## 4-2. Setting Power Saving Mode That Is Activated When the User Moves Away

By setting the Presence Sensor, you can set the monitor to automatically enter the power saving mode and display no images on the screen when the user moves away from the monitor. The monitor returns from the power saving mode when the user moves closer to the monitor. The length of time to pass before the monitor enters the power saving mode can be specified according to the operating environment of the monitor or the user's movement.

### Attention

- This feature is not available when "RadiCS SelfQC" is running.
- This feature is not available when "Power Save" is set to "Off".

### Note

- At the time of shifting to the power saving mode, a message appears notifying the user of the transition.

### Procedure

1. Select "Preferences" from the Setting menu, then select .
2. Select "Presence Sensor", then .
3. Select "On" or "Off" using  or , then select .
4. When you have selected "On", configure the advanced settings.

Item	Setting range	Description
Time	5, 30 sec 1, 3, 5, 10, 15, 30, 45, 60 min	Specify the length of time to pass before the "No presence detected." message appears after the user moves away from the monitor. If the message appears, the monitor enters the power saving mode after approximately 20 seconds.
Sensitivity	Level 5 Level 4 Level 3 Level 2 Level 1	A larger setting value allows the sensor to detect the user's movement more sensitively. This makes it difficult for the monitor to enter the power saving mode. On the other hand, a smaller setting value allows the sensor to detect only distinct movement of the user and consequently enables the monitor to enter the power saving mode more easily. The Presence Sensor functions by detecting the movement of heat using the sensor on the front of the monitor. The sensitivity varies with the user's clothing and ambient temperature. If you find transition to the power saving mode or recovery from it occurs unexpectedly, change the setting value.
Reset	-	Resets all settings related to the Presence Sensor to their default values.

### Note

- The sensitivity becomes lower at high ambient temperatures. In this environment, you can set a larger sensitivity value for your easier operation. On the other hand, the sensitivity becomes higher at low temperatures, and accordingly a smaller sensitivity value is required.

# Chapter 5 Configuring Monitor Settings

## 5-1. Specifying the Language

The language for the Setting menu and messages can be selected.

### Selectable Languages

English, Germany, French, Spanish, Italian, Swedish, Japanese, Chinese (simplified), Chinese (traditional)

### Procedure

1. Select "Languages" from the Setting menu, then select .
2. Select a language, then .

## 5-2. Showing the Icon for Switching the USB Ports in the Operation Guide

You can specify whether to display  in the operation guide.

### Procedure

1. Select "Preferences" from the Setting menu, then select .
  2. Select "USB Selection", then .
  3. Select "On" or "Off" using  or , then select .
- If "On" is selected, the icon for switching the USB ports is shown in the operation guide.

### Attention

- If "Off" is specified, the PC currently connected to "USB-1" is enabled even when "USB-2" is selected.

## 5-3. Switching PCs Used to Operate USB Devices

Switch PCs used to operate USB devices.

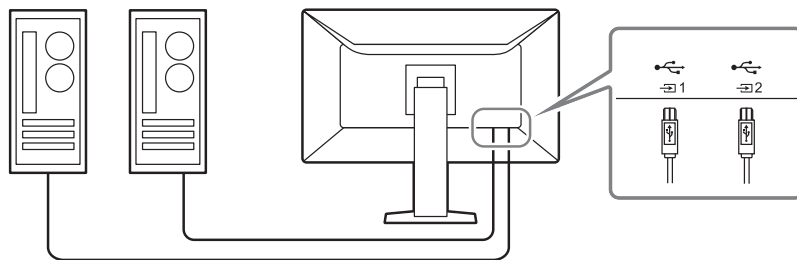

### Attention

- Before changing the setting, remove all USB memory devices from the monitor if connected. Otherwise, data may be lost or damaged.
- The PC used for monitor quality control purposes must be connected to .

### Procedure

1. Touch any switch (except .
  2. Select  from the operation guide.
  3. Select "USB-1" or "USB-2" using  or , then select .
- Select the USB upstream port to which the PC used for operation is connected.











## 5-4. Setting the Signal Format of DisplayPort 1

You can specify the DisplayPort 1 version, and enable or disable daisy-chain connection.

### ● Switching the DisplayPort 1 version

The version of the DisplayPort standard differs depending on the PC. If the screen does not appear even after the monitor and PC are connected properly, the versions may not match between them. In this case, try changing the version setting on the monitor.

#### **Procedure**

1. Select  to turn off the monitor.
2. While touching the leftmost switch (  ), touch  for more than two seconds to turn on the monitor.
3. Select "Signal Format" from "Administrator Settings", then select .
4. Select "DisplayPort 1", then .
5. Select "Version", then .
6. Select "1.1" or "1.2" using  or , then select .
7. Press  twice.  
The "Administrator Settings" menu appears.
8. Select "Apply", and then select .

### ● Enabling or disabling daisy-chain connection

Enable or disable daisy-chain connection. Setting this option to "On" enables a signal to be output from the DisplayPort output terminal to another monitor or DisplayPort 2.

---











#### **Attention**

- To enable daisy-chain connection, select "DisplayPort 1" and set "Version" to "1.2".
- Visit the EIZO website for information about monitors and graphic boards that can be used for the daisy-chain connection:

<http://www.eizoglobal.com>

---

#### **Procedure**

1. Select  to turn off the monitor.
2. While touching the leftmost switch (  ), touch  for more than two seconds to turn on the monitor.
3. Select "Signal Format" from "Administrator Settings", then select .
4. Select "DisplayPort 1", then .
5. Select "Daisy Chain", then .
6. Select "On" or "Off" using  or , then select .
7. Press  twice.  
The "Administrator Settings" menu appears.
8. Select "Apply", and then select .





## 5-5. Adjusting Brightness of the Power Switch Indicator

The brightness of the power switch indicator (green) while the screen is displayed can be adjusted. The larger the set value, the brighter the power indicator lights up. On the other hand, the smaller the value, the darker it becomes. The "Off" setting turns off the power switch indicator.

### Setting Range

1 to 7, Off

### Procedure







1. Select "Preferences" from the Setting menu, then select .
2. Select "Indicator", then .
3. Specify the setting using  or .
4. When the setting is complete, select .

## 5-6. Skipping Unused Display Modes

This function allows you to skip certain display modes when selecting a mode.

Please use this function if you want to limit the modes to be displayed, or avoid changing the display status randomly.

### Procedure

1. Select "Preferences" from the Setting menu, then select .
2. Select "Mode Skip", then .
3. Select a mode whose setting you want to change, then select .
4. Select "Skip" or "-" using  or , then select .

### Attention

- Not all modes can be disabled (skipped). Set at least one mode to "-".









## 5-7. Enabling or Disabling DisplayPort Communication in Power Saving Mode

Connecting a PC to the DisplayPort connector enables DisplayPort communication, and thus consumes high power even in the power saving mode. The communication can be disabled by setting "DP Power Save" to "On". This reduces power consumption in the power saving mode.

### Attention

- If "On" is selected, window and icon positions may shift when the monitor is powered back on or returned from the power saving mode. In such cases, set this function to "Off".

### Procedure







1. Select  to turn off the monitor.
2. While touching the leftmost switch (  ), touch  for more than two seconds to turn on the monitor.
3. Select "DP Power Save" in "Administrator Settings", then select .
4. Select "On" or "Off" using  or , then select .
5. Select "Apply", and then select .





## 5-8. Locking Operation Switches

Adjusted or set states can be made unchangeable.

### Procedure

1. Touch  to turn off the monitor.
2. While touching the leftmost switch (  ), touch  for more than two seconds to turn on the monitor.
3. Select "Key Lock" in "Administrator Settings", then select .
4. Select "Off", "Menu", or "All" using  or  , then select .

Setup item	Lockable switches
Off	None (All switches are enabled.)
Menu	Adjust or set using the Setting menu.
All	All switches except 

5. Select "Apply", and then select .

### Note

- After calibration is performed using RadiCS / RadiCS LE, "Menu" is selected.









## 5-9. Selecting the Input Signal for DDC Communication

Specify the input signal to be used for DDC communication. Using DDC communication allows you to use RadiCS / RadiCS LE without having to use the USB cable. (DDC communication differs from DDC / CI communication.)

### Attention

- In view of the accuracy and speed of communication, USB connection is recommended for RadiCS / RadiCS LE.

### Procedure

1. Touch  to turn off the monitor.
2. While touching the leftmost switch (  ), touch  for more than two seconds to turn on the monitor.
3. Select "DDC" in "Administrator Settings", then select .
4. Select "Off", "DVI", or "DisplayPort 1" using  or  , then select .
5. Select "Apply", and then select .









## 5-10. Setting Whether to Display / Hide the Grayscale Warning

You can specify whether to display the Grayscale Display Error message to indicate that a 6-bit (64-grayscale) signal has been detected when the DisplayPort signal is input at the recommended resolution. If the error message appears, please turn off the main power, and then turn it on again.

### Attention

- Always use with this set to "ON" (the default setting is "ON").
- Set this to "OFF" only when using 6bit (64 grayscale) display.

### Procedure

1. Select  to turn off the monitor.
2. While touching the leftmost switch (  ), touch  for more than two seconds to turn on the monitor.
3. Select "Grayscale Warning" in "Administrator Settings", then select .
4. Select "On" or "Off" using  or  , then select .
5. Select "Apply", and then select .

## 5-11. Acquiring Life Estimation Data

You can acquire data required to estimate the monitor's lifespan. The life estimation result based on the acquired data can be confirmed using RadiCS / RadiCS LE.

### Note

- Data is collected every 100 hours.
- If you selected "Power Save" and 100 hours have elapsed, the data collection process runs when the monitor enters the power saving mode or the power is turned off.
- If "Routine" or "Power Save" is selected, the Integrated Front Sensor starts measurement at the time of data collection. If "Off" is selected, measurement using the Integrated Front Sensor is not performed at the time of data collection.
- The collected data is saved at the following timings:
  - 500, 1000, 2000, 4000, 7000, 10000, 15000, 20000, 25000, and 30000 hours.

### Procedure

1. Select "RadiCS SelfQC" from the Setting menu, then select .
2. Select "LEA" for "RadiCS SelfQC", then select .
3. Select "Meas. Frequency".
4. Select "Power Save", "Routine", or "Off", then select .

## 5-12. Rotating the Setting Menu Display

The display orientation of the Setting menu can be changed.





### Procedure

1. Select "Preferences" from the Setting menu, then select .
2. Select "Menu Rotation", then select .
3. Select "0°" or "90°", then select .

## 5-13. Setting Whether to Display / Hide the EIZO Logo

You can select whether to display or hide the EIZO logo when the monitor starts.

### Procedure

1. Touch  to turn off the monitor.
2. While touching the leftmost switch (  ), touch  for more than two seconds to turn on the monitor.
3. Select "On-Screen Logo" in "Administrator Settings", then select .
4. Select "On" or "Off" using  or  , then select .
5. Select "Apply", and then select .

## 5-14. Viewing the Monitor Information

View information related to the input signals that are currently displayed and the monitor.

### Procedure

1. Select "Information" from the Setting menu, then select .  
Input signal information, model name, serial number, firmware version, and usage time are displayed.  
The asset tag number is only displayed when it has been set using RadiCS / RadiCS LE.

Example:

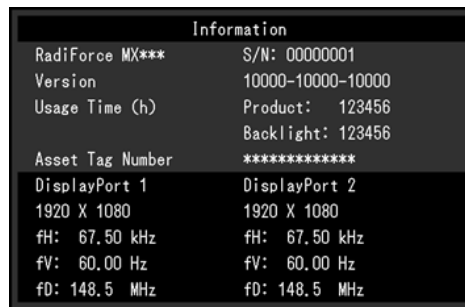

Information	
RadiForce MX***	S/N: 00000001
Version	10000-10000-10000
Usage Time (h)	Product: 123456
	Backlight: 123456
Asset Tag Number	*****
DisplayPort 1	DisplayPort 2
1920 X 1080	1920 X 1080
fH: 67.50 kHz	fH: 67.50 kHz
fV: 60.00 Hz	fV: 60.00 Hz
fD: 148.5 MHz	fD: 148.5 MHz

### Attention

- The usage time may not be "0" at the time of your purchase because inspections and other processes had been carried out on the monitor before it was shipped from the factory.

## 5-15. Resetting to Defaults

There are two different reset functions: One that only resets the color adjustments to default settings, and the other that resets all settings to defaults.

### Attention

- The previous settings cannot be recovered after they were reset to defaults.

### Note

- For information about default settings, see "7-3. Main Default Settings" (page 34).

### ● Resetting the color adjustment value

Only the adjustment value for the currently selected mode is reset to the default setting.

#### Procedure

1. Select "CAL Switch Mode" from the Setting menu, then select .
2. Select "Reset", then .
3. Select "OK", then .

The color adjustment value reverts to the default setting.

### ● Resetting all settings

Restore all settings to their default values (except for "Input" and "Administrator Settings").





#### Procedure

1. Select "Preferences" from the Setting menu, then select .
2. Select "Monitor Reset" for "Preferences", then select .
3. Select "OK" using  or , then select .

All settings except for "Input" and "Administrator Settings" are reset to defaults.

# Chapter 6 Troubleshooting

## 6-1. No Picture

Problem	Possible cause and remedy
<p><b>1. No picture</b></p> <ul style="list-style-type: none"> <li>Power switch indicator does not light up.</li> </ul> <hr/> <ul style="list-style-type: none"> <li>Power switch indicator lights up: Green</li> </ul> <hr/> <ul style="list-style-type: none"> <li>Power switch indicator lights up: Orange</li> </ul> <hr/> <ul style="list-style-type: none"> <li>Power switch indicator blinks: Orange, Green</li> </ul>	<ul style="list-style-type: none"> <li>Check whether the power cord is connected properly.</li> <li>Turn the main power switch on.</li> <li>Touch .</li> <li>Turn off the main power, and then turn it on again.</li> <li>Increase "Brightness", "Contrast", or "Gain" in the Setting menu (see "2-5. Adjusting Brightness / Colors" (page 13)).</li> <li>Turn off the main power, and then turn it on again.</li> <li>Try switching the input signal (see "2-2. Setting Screen Layout (Single / Dual) and Input Signal" (page 9)).</li> <li>Move the mouse or press any key on the keyboard.</li> <li>Check whether the PC is turned on.</li> <li>If the Presence Sensor is set to "On", the monitor may be in power saving mode. Try moving closer to the monitor.</li> <li>Is the DisplayPort signal connected correctly? If "DisplayPort 1" is selected for the input signal, connect it to .  is used for output when a daisy-chain connection is set up.</li> <li>Turn off the main power, and then turn it on again.</li> <li>Connect via the signal cable specified by EIZO. Turn off the main power, and then turn it on again.</li> <li>If the signal cable is connected to DisplayPort 1, try switching the DisplayPort version (see "5-4. Setting the Signal Format of DisplayPort 1" (page 23)).</li> </ul>
<p><b>2. The message below appears.</b></p> <ul style="list-style-type: none"> <li>This message appears when no signal is input. Example:</li> </ul> <div data-bbox="256 1279 655 1424" style="border: 1px solid black; background-color: black; color: white; padding: 10px; text-align: center;"> <p>DisplayPort 1 No Signal</p> </div> <hr/> <ul style="list-style-type: none"> <li>The message indicates that the input signal is out of the specified frequency range. (Frequencies out of the specified range are shown in magenta.) Example:</li> </ul> <div data-bbox="256 1760 655 1906" style="border: 1px solid black; background-color: black; color: white; padding: 10px; text-align: center;"> <p>DisplayPort 1 Signal Error</p> </div>	<p>This message appears when the signal is not input correctly even though the monitor is functioning properly.</p> <hr/> <ul style="list-style-type: none"> <li>The message shown left may appear, because some PCs do not output the signal immediately after power-on.</li> <li>Check whether the PC is turned on.</li> <li>Check whether the signal cable is connected properly.</li> <li>Try switching the input signal (see "2-2. Setting Screen Layout (Single / Dual) and Input Signal" (page 9)).</li> <li>If the signal cable is connected to DisplayPort, try switching the DisplayPort version (see "5-4. Setting the Signal Format of DisplayPort 1" (page 23)).</li> <li>If "DisplayPort 1" is selected for the input signal, connect it to .  is used for output when a daisy-chain connection is set up.</li> <li>Turn off the main power, and then turn it on again.</li> </ul> <hr/> <ul style="list-style-type: none"> <li>Check whether the PC is configured to meet the resolution and vertical scan frequency requirements of the monitor (see "Compatible Resolutions" in the Instructions for Use).</li> <li>Reboot the PC.</li> <li>Select an appropriate setting using the graphics board's utility. For more information, refer to the User's Manual of the graphics board.</li> </ul>

## 6-2. Imaging Problems

Problem	Possible cause and remedy
1. The screen is too bright or too dark.	<ul style="list-style-type: none"> <li>Use “Brightness” or “Contrast” in the Setting menu to adjust it. (The LCD monitor backlight has a limited life span. When the screen becomes dark or begins to flicker, contact your local EIZO representative.)</li> </ul>
2. Text is blurred	<ul style="list-style-type: none"> <li>Check whether the PC is configured to meet the resolution and vertical scan frequency requirements of the monitor (see “Compatible Resolutions” in the Instructions for Use).</li> </ul>
3. Afterimages appear	<ul style="list-style-type: none"> <li>Afterimages are particular to LCD monitors. Avoid displaying the same image for a long time.</li> <li>Use the screen saver or power saving function to avoid displaying the same image for extended periods of time.</li> <li>An afterimage may appear even after a short time period has elapsed depending on the displayed image. If this occurs, changing the image or leaving the power off for a few hours may solve the problem.</li> </ul>
4. Green / red / blue / white dots or dark dots remain on the screen.	<ul style="list-style-type: none"> <li>This is due to LCD panel characteristics and not a malfunction.</li> </ul>
5. Interference patterns or traces created when selecting panels remain on the screen.	<ul style="list-style-type: none"> <li>Display a white or black image over the entire screen. The symptom may disappear.</li> </ul>
6. (When images are displayed on one screen in PbyP mode) The timing at which they appear differs between the left and right sides of the screen.	<ul style="list-style-type: none"> <li>When images are displayed on one screen in PbyP mode, the timing at which they appear may differ between the left and right sides of the monitor depending on the graphics board. This symptom can be removed by changing the monitor display setting to the single screen mode (see “2-2. Setting Screen Layout (Single / Dual) and Input Signal” (page 9)).</li> </ul>

## 6-3. Other Problems

Problem	Possible cause and remedy
1. The Setting menu does not appear.	<ul style="list-style-type: none"> <li>• Check whether the operation switch lock function has been activated (see “5-8. Locking Operation Switches” (page 25)).</li> </ul>
2. The Mode menu does not appear.	<ul style="list-style-type: none"> <li>• Check whether the operation switch lock function has been activated (see “5-8. Locking Operation Switches” (page 25)).</li> </ul>
3. The operation switches do not work.	<ul style="list-style-type: none"> <li>• Check whether the operation switch lock function has been activated (see “5-8. Locking Operation Switches” (page 25)).</li> <li>• Check whether there are any water droplets or foreign objects on the switch surface. Gently wipe the switch surface and try operating the switches again with dry hands.</li> <li>• Are you wearing gloves? If so, remove the gloves and try operating the switches again with dry hands.</li> </ul>
4. (When the Presence Sensor is used) The screen does not go off even when you move away from the monitor, or the screen does not appear even when you move closer to the monitor.	<ul style="list-style-type: none"> <li>• Check the installation environment of the monitor. It may not operate correctly in the following environments. <ul style="list-style-type: none"> <li>- Is the monitor installed in a windy location?</li> <li>- Are there any heat-generating devices near the monitor?</li> <li>- Are there any obstacles in front of the monitor?</li> </ul> </li> <li>• Is there any dirt on the sensor? If so, remove the dirt using a soft cloth.</li> <li>• Are you sitting still in front of the monitor? The Presence Sensor functions by detecting the movement of heat using the sensor on the front of the monitor.</li> <li>• The monitor may not return from the power saving mode if the ambient temperature is high. If the monitor will not come back on even after moving the mouse or pressing keys on the keyboard, use the power switch to turn off the monitor, and then turn it on again. When the monitor comes back, change the sensitivity to a larger value (see “5-7. Enabling or Disabling DisplayPort Communication in Power Saving Mode” (page 24)).</li> </ul>
5. The monitor does not enter the power saving mode.	<ul style="list-style-type: none"> <li>• Regardless of whether the PinP sub window is displayed or not, the monitor may not enter the power saving mode when a signal is input to the PinP sub window.</li> </ul>
6. The monitor connected using the USB cable is not detected or the USB device (peripheral) connected to the monitor does not work.	<ul style="list-style-type: none"> <li>• Check whether the USB cable is connected correctly (see “7-2. How to Use USB Hub Function” (page 33)).</li> <li>• Try changing to a different USB port on the PC.</li> <li>• Try changing to a different USB port on the monitor.</li> <li>• Reboot the PC.</li> <li>• Try switching PCs used to operate the peripheral (see “5-3. Switching PCs Used to Operate USB Devices” (page 22)).</li> <li>• If the peripheral works normally when directly connected to the PC, contact your dealer or local EIZO representative.</li> <li>• Check whether the PC and OS are USB compliant. (For USB compliance of the respective devices, consult their manufacturers.)</li> <li>• Check the PC’s BIOS setting for USB when using Windows. (Refer to the manual of the PC for details.)</li> </ul>

Problem	Possible cause and remedy
7. Power is turned off during operation, and the screen does not appear.	<ul style="list-style-type: none"> <li>The monitor turns off automatically when the internal temperature is excessively high. If you switch the power on in a high-temperature state, the monitor turns off again in one minute.</li> <li>Change the installation location or environment, wait for a few minutes, and then turn the power on again. <ul style="list-style-type: none"> <li>Is the ventilation slot blocked?</li> <li>Are there any hot objects near the monitor?</li> </ul> </li> <li>If the power still does not turn on even after changing the location or environment, contact your local EIZO representative.</li> </ul> <p><b>Attention</b></p> <ul style="list-style-type: none"> <li>Do not block the monitor's ventilation slot, nor use the monitor in a poorly ventilated location.</li> </ul>
8. The Integrated Front Sensor stays out.	<ul style="list-style-type: none"> <li>Turn off the main power, and then turn it on again.</li> </ul>
9. Starting RadiCS takes a long time.	<ul style="list-style-type: none"> <li>Use the attached USB cable.</li> </ul>
10. Some RadiCS functions cannot be used.	<ul style="list-style-type: none"> <li>If you are using Windows 10, some RadiCS functions cannot be used when the Windows screen size is set to other than 100 %. Right-click the mouse anywhere on the desktop except on icons, select "Display settings", and specify 100 % for "Change the size of text, apps, and other items" setting. (Refer to the manual of the PC for details.)</li> </ul>
11. SelfCalibration / Grayscale Check fails.	<ul style="list-style-type: none"> <li>Refer to the following error code table.</li> </ul> <p><b>Attention</b></p> <ul style="list-style-type: none"> <li>Do not touch the Integrated Front Sensor.</li> </ul>
12. The SelfCalibration / Grayscale Check history does not display the clock time correctly.	<ul style="list-style-type: none"> <li>Perform monitor detection using RadiCS / RadiCS LE. For details, refer to the RadiCS / RadiCS LE User's Manual.</li> </ul>

## ● Error Code Table

Error Code	Description
0***	<ul style="list-style-type: none"> <li>An error that has occurred during SelfCalibration</li> </ul>
1***	<ul style="list-style-type: none"> <li>An error that has occurred during Grayscale Check</li> </ul>
*1**	<ul style="list-style-type: none"> <li>An error that has occurred at DICOM</li> </ul>
*2**	<ul style="list-style-type: none"> <li>An error that has occurred at CAL1</li> </ul>
*3**	<ul style="list-style-type: none"> <li>An error that has occurred at CAL2</li> </ul>
**10	<ul style="list-style-type: none"> <li>The maximum brightness of the monitor may be lower than the target brightness.</li> <li>Try reducing the target brightness.</li> </ul>
**11	<ul style="list-style-type: none"> <li>The minimum brightness of the monitor may be higher than the target minimum brightness.</li> <li>Try increasing the target minimum brightness.</li> </ul>
**34	<ul style="list-style-type: none"> <li>The sensor may not have worked correctly.</li> <li>Turn off the main power, wait for a few minutes, turn the power back on, and then run SelfCalibration / Grayscale Check again.</li> </ul>
**61	<ul style="list-style-type: none"> <li>The sensor may not have worked correctly.</li> <li>Check whether there is any foreign object near the sensor.</li> <li>Run SelfCalibration / Grayscale Check again.</li> </ul>
**95	<ul style="list-style-type: none"> <li>The SelfCalibration / Grayscale Check execution conditions may not be correct.</li> <li>Check the execution conditions and correct them as necessary.</li> </ul>

# Chapter 7 Reference

## 7-1. Arm Installation Procedure

Another manufacturer's arm (or another manufacturer's stand) can be attached by removing the stand section.

### Attention

- When attaching an arm or stand, follow the instructions of the respective User's Manual.
- Be sure to use landscape. Using portrait display may result in display malfunctions.
- When using another manufacturer's arm or stand, confirm the following in advance and select one conforming to the VESA standard.
  - Clearance between the screw holes: 100 mm × 100 mm
  - VESA mount of the arm or stand, external dimensions: 122 mm x 122 mm or less
  - Strong enough to support weight of the monitor unit (excluding the stand) and attachments such as cables.
- When using another manufacturer's arm or stand, use the following screws to secure it.
  - Screws fixing the stand to the monitor
- When using an arm or stand, attach it to meet the following tilt angles of the monitor.
  - Up 45°, down 45° (for landscape orientation)
- Connect the cables after attaching an arm or stand.
- Do not move the removed stand up and down. Doing so may result in injury or device damage.
- The monitor, arm, and stand are heavy. Dropping them may result in injury or equipment damage.
- Periodically check the tightness of the screws. If not sufficiently tight, the monitor may detach from the arm, which may result in injury or equipment damage.

### Attachment procedure

**1. In order to prevent the panel surface from being damaged, lay the monitor on a soft cloth spread on a stable surface with the panel surface facing down.**

**2. Remove the stand.**

Prepare a screwdriver. Using a screwdriver, remove the screws (four) securing the unit and the stand.

**3. Attach the arm or stand to the monitor.**

Use the screws that you removed in step 2 to attach the arm (or stand) to the monitor.

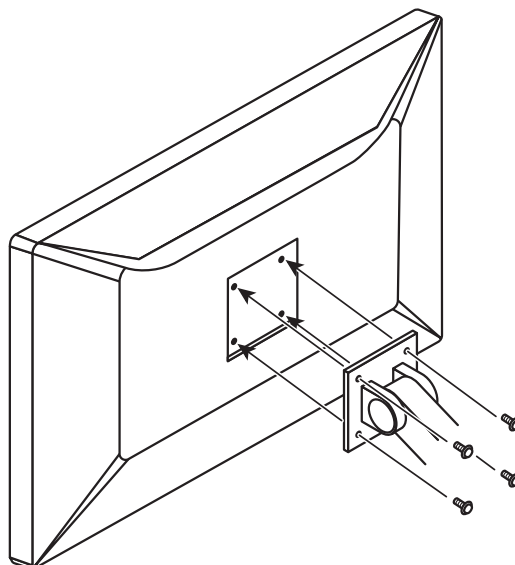



## 7-2. How to Use USB Hub Function

This monitor is equipped with a USB hub. Connected to a PC compatible with USB or another monitor with a USB hub, this monitor functions as a USB hub allowing connection to peripheral USB devices.

### Connection procedure

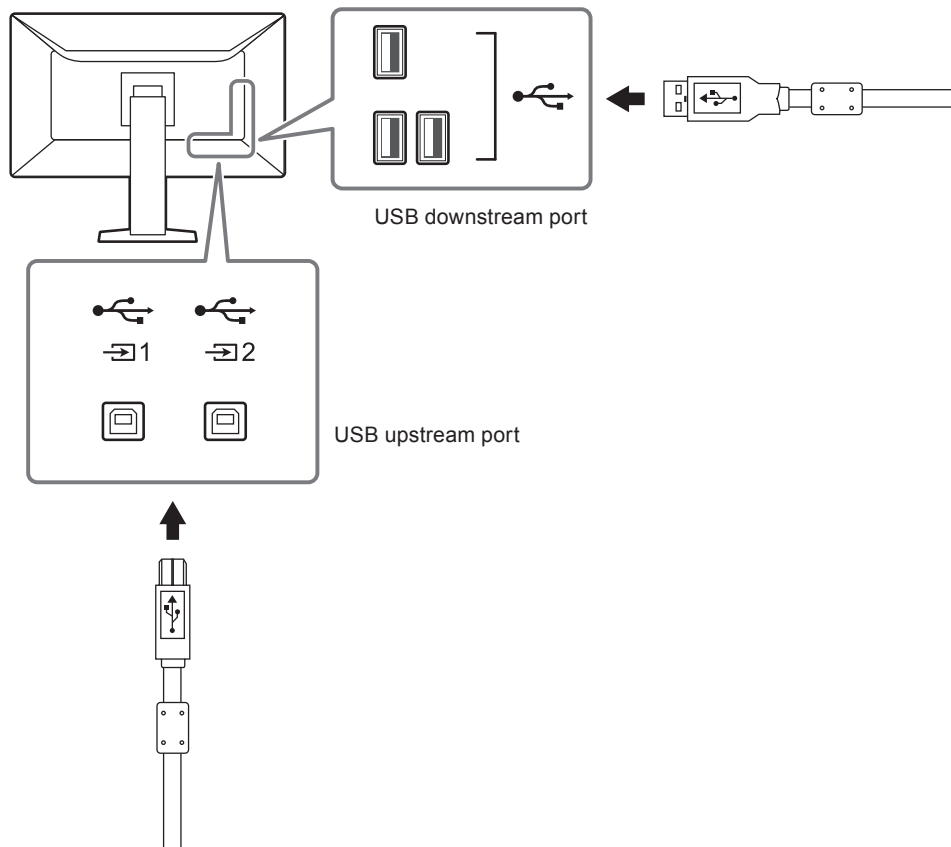

1. Connect the supplied USB cable between the USB downstream port of a PC (or another monitor that has a USB hub) and the monitor's USB upstream port.
2. Connect the peripheral USB device to the USB downstream port of the monitor.



#### Attention

- When the main power switch is Off, device connected to the USB port will not operate.

#### Note

- By factory default, a cap is attached to . Remove the cap before using .
- By default,  is enabled. If you want to connect two PCs and switch them to operate USB devices, see [“5-3. Switching PCs Used to Operate USB Devices” \(page 22\)](#).

## 7-3. Main Default Settings

**CAL Switch Mode: Factory default display setting is "1-DICOM".**

Mode	Brightness	Temperature	Gamma value
1-DICOM	270 cd/m <sup>2</sup>	7500 K	DICOM
2-CAL1	270 cd/m <sup>2</sup>	7500 K	2.2
3-CAL2	180 cd/m <sup>2</sup>	7500 K	DICOM
4-Custom	Approx. 180 cd/m <sup>2</sup>	7500 K	2.2
5-sRGB	Approx. 180 cd/m <sup>2</sup>	sRGB	sRGB
6-Text	Approx. 100 cd/m <sup>2</sup>	6500 K	2.2

### Others

LEA		Power Save
Warning		Off
QC History		On
Input		DisplayPort 1 <sup>*1</sup>
Power Save		High
Indicator		4
Menu Rotation		0°
USB Selection		Off
PinP	PinP Display	Off
	Input	DisplayPort 2 <sup>*1</sup>
	CAL Switch Mode	Text
	Position	Upper Right
Presence Sensor		Off
	Time	10 min
	Sensitivity	Level 4
Mode Skip		- (Display all)
Language		English
On-Screen Logo		Off <sup>*1</sup>
Key Lock		Off <sup>*1</sup>
DDC		DisplayPort 1 <sup>*1</sup>
DP Power Save		Off <sup>*1</sup>
Grayscale Warning		On <sup>*1</sup>
Sharpness Recovery		On <sup>*1</sup>
DisplayPort 1	Version	1.2 <sup>*1</sup>
	Daisy Chain	Off <sup>*1</sup>
USB Selection (  )		USB-1

\*1 These menus cannot be initialized by executing "Monitor Reset" (see ["Resetting all settings" \(page 27\)](#)).

# Appendix

## Trademark

The terms HDMI and HDMI High-Definition Multimedia Interface, and the HDMI Logo are trademarks or registered trademarks of HDMI Licensing, LLC in the United States and other countries.

The DisplayPort Compliance Logo and VESA are registered trademarks of the Video Electronics Standards Association.

The SuperSpeed USB Trident Logo is a registered trademark of USB Implementers Forum, Inc.



Kensington and Microsaver are registered trademarks of ACCO Brands Corporation.

Thunderbolt is a trademark of Intel Corporation in the United States and / or other countries.

Microsoft, Windows and Windows Vista are registered trademarks of Microsoft Corporation in the United States and other countries.

Adobe is a registered trademark of Adobe Systems Incorporated in the United States and other countries.

Apple, Mac OS, OS X, Macintosh and ColorSync are registered trademarks of Apple Inc.

EIZO, the EIZO Logo, ColorEdge, DuraVision, FlexScan, FORIS, RadiCS, RadiForce, RadiNET, Raptor and ScreenManager are registered trademarks of EIZO Corporation in Japan and other countries.

ColorEdge Tablet Controller, ColorNavigator, CuratOR, EcoView NET, EIZO EasyPIX, EIZO Monitor Configurator, EIZO ScreenSlicer, G-Ignition, i • Sound, Quick Color Match, RadiLight, Re / Vue, Screen Administrator, Screen InStyle and UniColor Pro are trademarks of EIZO Corporation.

All other company and product names are trademarks or registered trademarks of their respective owners.

## License

A bitmap font designed by RICOH Industrial Solutions Inc. is used for the characters displayed on this product.

# LIMITED WARRANTY

---

EIZO Corporation (hereinafter referred to as “EIZO”) and distributors authorized by EIZO (hereinafter referred to as the “Distributors”) warrant, subject to and in accordance with the terms of this limited warranty (hereinafter referred to as the “Warranty”), to the original purchaser (hereinafter referred to as the “Original Purchaser”) who purchased the product specified in this document (hereinafter referred to as the “Product”) from EIZO or Distributors, that EIZO and Distributors shall, at their sole discretion, either repair or replace the Product at no charge if the Original Purchaser becomes aware within the Warranty Period (defined below) that (i) the Product malfunctions or is damaged in the course of normal use of the Product in accordance with the description in the instruction manual attached to the Product (hereinafter referred to as the “User’s Manual”), or (ii) the LCD panel and brightness of the Product cannot maintain the recommended brightness specified in the User’s Manual in the course of normal use of the Product in accordance with the description of the User’s Manual.

The period of this Warranty is five (5) years from the date of purchase of the Product (hereinafter referred to as the “Warranty Period”). However, the brightness of the Product shall be warranted only if the Product has been used within the recommended brightness described in the User’s Manual. The Warranty Period for the brightness is also limited to five (5) years from the date of purchase of the Product subject to the usage time being less than or equal to 10,000 hours (the brightness is 270 cd/m<sup>2</sup> and color temperature is 7500K). EIZO and Distributors shall bear no liability or obligation with regard to the Product in relation to the Original Purchaser or any third parties other than as provided under this Warranty.

EIZO and Distributors will cease to hold or store any parts (excluding design parts) of the Product upon expiration of seven (7) years after the production of the Product is discontinued. In repairing the monitor, EIZO and Distributors will use renewal parts which comply with our QC standards. If the unit cannot be repaired due to its condition or the stockout of a relevant part, EIZO and Distributors may offer the replacement by a product with equivalent performance instead of repairing it.

The Warranty is valid only in the countries or territories where the Distributors are located. The Warranty does not restrict any legal rights of the Original Purchaser.

Notwithstanding any other provision of this Warranty, EIZO and Distributors shall have no obligation under this Warranty whatsoever in any of the cases as set forth below:

- (a) Any defect of the Product caused by freight damage, modification, alteration, abuse, misuse, accident, incorrect installation, disaster, faulty maintenance and/or improper repair by third party other than EIZO and Distributors;
- (b) Any incompatibility of the Product due to possible technical innovations and/or regulations;
- (c) Any deterioration of the sensor;
- (d) Any defect of the Product caused by external equipment;
- (e) Any defect of the Product on which the original serial number has been altered or removed;
- (f) Any normal deterioration of the product, particularly that of consumables, accessories, and/or attachments (e.g. buttons, rotating parts, cables, User’s Manual, etc.);
- (g) Any deformation, discoloration, and/or warp of the exterior of the product including that of the surface of the LCD panel;
- (h) Any defect of the Product caused by placement in a location where it may be affected by strong vibration or shocks;
- (i) Any defect of the Product caused by liquid leaking from battery;
- (j) Any deterioration of the Product caused by the use at higher brightness than the recommended brightness described in the User’s Manual; and
- (k) Any deterioration of display performance caused by the deterioration of expendable parts such as the LCD panel and/or backlight, etc. (e.g. changes in brightness uniformity, changes in color, changes in color uniformity, defects in pixels including burnt pixels, etc.).

To obtain service under the Warranty, the Original Purchaser must deliver the Product, freight prepaid, in its original package or other adequate package affording an equal degree of protection, assuming the risk of damage and/or loss in transit, to the local Distributor. The Original Purchaser must present proof of purchase of the Product and the date of such purchase when requesting services under the Warranty.

The Warranty Period for any replaced and/or repaired product under this Warranty shall expire at the end of the original Warranty Period.

EIZO OR DISTRIBUTORS ARE NOT RESPONSIBLE FOR ANY DAMAGE TO, OR LOSS OF, DATA OR OTHER INFORMATION STORED IN ANY MEDIA OR ANY PART OF ANY PRODUCT RETURNED TO EIZO OR DISTRIBUTORS FOR REPAIR.

EIZO AND DISTRIBUTORS MAKE NO FURTHER WARRANTIES, EXPRESSED OR IMPLIED, WITH RESPECT TO THE PRODUCT AND ITS QUALITY, PERFORMANCE, MERCHANTABILITY OR FITNESS FOR ANY PARTICULAR USE. IN NO EVENT SHALL EIZO OR DISTRIBUTORS BE LIABLE FOR ANY INCIDENTAL, INDIRECT, SPECIAL, CONSEQUENTIAL OR OTHER DAMAGE WHATSOEVER (INCLUDING, WITHOUT LIMITATION, DAMAGES FOR LOSS OF PROFIT, BUSINESS INTERRUPTION, LOSS OF BUSINESS INFORMATION, OR ANY OTHER PECUNIARY LOSS) ARISING OUT OF THE USE OR INABILITY TO USE THE PRODUCT OR IN ANY CONNECTION WITH THE PRODUCT, WHETHER BASED ON CONTRACT, TORT, NEGLIGENCE, STRICT LIABILITY OR OTHERWISE, EVEN IF EIZO OR DISTRIBUTORS HAVE BEEN ADVISED OF THE POSSIBILITY OF SUCH DAMAGES. THIS EXCLUSION ALSO INCLUDES ANY LIABILITY WHICH MAY ARISE OUT OF THIRD PARTY CLAIMS AGAINST THE ORIGINAL PURCHASER. THE ESSENCE OF THIS PROVISION IS TO LIMIT THE POTENTIAL LIABILITY OF EIZO AND DISTRIBUTORS ARISING OUT OF THIS LIMITED WARRANTY AND/OR SALES.

# Recycling Information

## Recycling Information

This product, when disposed of, is supposed to be collected and recycled according to your country's legislation to reduce environmental burden. When you dispose of this product, please contact a distributor or an affiliate in your country.

The contact addressees are listed on the EIZO website below.  
<http://www.eizoglobal.com>

For recycling information for customers in Switzerland, please refer to the following website.  
<http://www.swico.ch>

## Informationen zum Thema Recycling

Dieses Produkt muss gemäß den Vorschriften Ihres Landes zur Entlastung der Umwelt recyclet werden. Wenden Sie sich bei der Entsorgung dieses Produkts an einen Verteiler oder eine Tochtergesellschaft in Ihrem Land.

Die Adressen zur Kontaktaufnahme sind auf der unten angegebenen Website von EIZO aufgeführt.  
<http://www.eizoglobal.com>

Kunden in der Schweiz entnehmen Informationen zum Recycling der folgenden Website:  
<http://www.swico.ch>

## Informations sur le recyclage

Ce produit doit être jeté aux points de collecte prévus à cet effet et recyclé conformément à la législation de votre pays, afin de réduire l'impact sur l'environnement. Lorsque vous jetez ce produit, veuillez contacter un distributeur ou une société affiliée de votre pays.

Les adresses des distributeurs sont répertoriées sur le site Web EIZO ci-dessous.  
<http://www.eizoglobal.com>

Pour les clients en Suisse, veuillez consulter le site Web suivant afin d'obtenir des informations sur le recyclage.  
<http://www.swico.ch>

## Información sobre reciclaje

Este producto debe desecharse y reciclarse según la legislación del país para reducir el impacto medioambiental. Cuando desee deshacerse de este producto, póngase en contacto con un distribuidor o una filial de su país.

Encontrará las direcciones de contacto en el sitio web de EIZO que se indica a continuación.  
<http://www.eizoglobal.com>

## Informazioni sul riciclaggio

Per lo smaltimento e il riciclaggio del presente prodotto, attenersi alle normative vigenti nel proprio paese per ridurre l'impatto ambientale. Per lo smaltimento, rivolgersi ad un distributore o un affiliato presenti nel proprio paese.

Gli indirizzi sono elencati nel sito Web EIZO riportato di seguito.  
<http://www.eizoglobal.com>

Per informazioni sul riciclaggio per i clienti in Svizzera, consultare il sito Web riportato di seguito.  
<http://www.swico.ch>

## Återvinningsinformation

När denna produkt kasseras ska den hanteras och återvinnas enligt landets föreskrifter för att reducera miljöpåverkan. När du kasserar produkten ska du kontakta en distributör eller representant i ditt land.

Kontaktadresserna listas på EIZO-webbplatsen nedan.  
<http://www.eizoglobal.com>

## Πληροφορίες ανακύκλωσης

Το προϊόν αυτό, όταν απορρίπτεται, πρέπει να συλλέγεται και να ανακυκλώνεται σύμφωνα με τη νομοθεσία της χώρας σας έτσι ώστε να μην επιβαρύνει το περιβάλλον. Για να απορρίψετε το προϊόν, επικοινωνήστε με έναν αντιπρόσωπο ή μια θυγατρική εταιρεία στη χώρα σας.

Οι διευθύνσεις επικοινωνίας αναγράφονται στην τοποθεσία web της EIZO παρακάτω.

<http://www.eizoglobal.com>

## Сведения по утилизации

По истечении срока службы данного продукта его следует принести на сборный пункт и утилизировать в соответствии с действующими предписаниями в вашей стране, чтобы уменьшить вредное воздействие на окружающую среду. Прежде чем выбросить данный продукт, обратитесь к дистрибьютору или в местное представительство компании в вашей стране.

Контактные адреса можно найти на веб-узле EIZO.

<http://www.eizoglobal.com>

## Informatie over recycling

Wanneer u dit product wilt weggooien, moet het uit milieu-overwegingen worden verzameld en gerecycled volgens de betreffende wetgeving van uw land. Wanneer u dit product wilt weggooien, moet u contact opnemen met een distributeur of een partner in uw land.

De contactadressen worden vermeld op de volgende EIZO-website.

<http://www.eizoglobal.com>

## Informação sobre reciclagem

Este produto, quando o deitar fora, deve ser recolhido e reciclado de acordo com a legislação do seu país para reduzir a poluição. Quando deitar fora este produto, contacte um distribuidor ou uma filial no seu país.

Os endereços de contacto estão listados no website do EIZO, abaixo.

<http://www.eizoglobal.com>

## Oplysninger om genbrug

Dette produkt forventes ved bortskaffelse at blive indsamlet og genbrugt i overensstemmelse med lovgivningen i dit land for at reducere belastningen af miljøet. Når du bortskaffer denne produkt, skal du kontakte en distributør eller et tilknyttet selskab i dit land.

Adresserne på kontaktpersonerne er angivet på EIZO's websted nedenfor.

<http://www.eizoglobal.com>

## Kierrätystä koskevia tietoja

Tuote tulee hävittää kierrättämällä maan lainsäädännön mukaisesti ympäristön kuormittumisen vähentämiseksi. Kun hävität tuotteen, ota yhteyttä jälleenmyyjään tai tytäryhtiöön maassasi.

Yhteystiedot löytyvät EIZOn Internet-sivustolta.

<http://www.eizoglobal.com>

## Wykorzystanie surowców wtórnych

Ten produkt po zużyciu powinien być zbierany i przetwarzany zgodnie z krajowymi przepisami dotyczącymi ochrony środowiska. Wyrzucając ten produkt, należy skontaktować się z lokalnym dystrybutorem lub partnerem. Adresy kontaktowe można znaleźć we wskazanej poniżej witrynie internetowej firmy EIZO.

<http://www.eizoglobal.com>

## Informace o recyklaci

Při likvidaci produktu musí být produkt vyzvednut a recyklován podle zákonů příslušné země, aby nedocházelo k zatěžování životního prostředí. Zbavujete-li se produktu, kontaktujte distributora nebo pobočku ve své zemi. Kontaktní adresy jsou uvedeny na následující webové stránce společnosti EIZO.  
<http://www.eizoglobal.com>

## Ringlussevõtu alane teave

Keskkonnakoormuse vähendamiseks tuleks kasutatud tooted kokku koguda ja võtta ringlusse vastavalt teie riigi seadustele. Kui kõrvaldate käesoleva toote, võtke palun ühendust turustaja või filiaaliga oma riigis. Kontaktisikud on toodud EIZO veebilehel järgmisel aadressil:  
<http://www.eizoglobal.com>

## Újrahasznosítási információ

Jelen terméket, amikor eldobjuk, az illető ország törvényei alapján kell összegyűjteni és újrahasznosítani, hogy csökkentsük a környezet terhelését. Amikor ezt a terméket eldobja, kérjük lépjen kapcsolatba egy országon belüli forgalmazóval vagy társvállalkozással.  
A kapcsolat címei az EIZO alábbi weboldalán találhatók felsorolva:  
<http://www.eizoglobal.com>

## Podatki o recikliranju

Ob koncu uporabe odslužen izdelek izročite na zbirno mesto za recikliranje v skladu z okoljevarstveno zakonodajo vaše države. Prosimo, da se pri odstranjevanju izdelka obrnete na lokalnega distributerja ali podružnico.  
Kontaktne naslovi so objavljeni na spodaj navedenih spletnih straneh EIZO:  
<http://www.eizoglobal.com>

## Informácie o recyklácii

Pri likvidácii musí byť tento výrobok recyklovaný v súlade s legislatívou vašej krajiny, aby sa znížilo zaťaženie životného prostredia. Keď sa chcete zbaviť tohto výrobku, kontaktujte prosím distribútora alebo pobočku vo vašej krajine.  
Zoznam kontaktných adries je uvedený na nasledovnej webovej stránke firmy EIZO:  
<http://www.eizoglobal.com>

## Pārstrādes informācija

Utilizējot šo produktu, tā savākšana un pārstrāde veicama atbilstoši jūsu valsts likumdošanas prasībām attiecībā uz slodzes uz vidi samazināšanu. Lai veiktu šī produkta utilizāciju, sazinieties ar izplatītāju vai pārstāvniecību jūsu valstī.  
Kontaktadrese ir norādītas zemāk minētajā EIZO tīmekļa vietnē.  
<http://www.eizoglobal.com>

## Informacja apie gražinamąjį perdirbimą

Šalinant (išmetant) šiuos gaminius juos reikia surinkti ir perdirbti gražinamuoju būdu pagal jūsų šalies teisės aktus, siekiant sumažinti aplinkos teršimą. Kai reikia išmesti šį gaminį, kreipkitės į jūsų šalyje veikiančią gaminių pardavimo atstovybę arba jos filialą.  
Kontaktiniai adresatai nurodyti EIZO interneto svetainėje.  
<http://www.eizoglobal.com>

## Информация относно рециклиране

При изхвърлянето на този продукт се предлага събирането и рециклирането му съобразно законите на вашата страна за да се намали замърсяването на околната среда. Когато искате да се освободите от този продукт, моля свържете се с търговския му представител или със съответните органи отговарящи за това във вашата страна.

Данните за връзка с нас са описани на следния Интернет сайт на EIZO:  
<http://www.eizoglobal.com>

## Informație referitoare la reciclare

Acest produs, când debarasat, trebuie colectat și reciclat conform legislației țării respective ca să reducem sarcina mediului. Când se debarasează de acest produs, vă rugăm să contactați un distribuitor sau un afiliat al țării respective.

Adresele de contact le găsiți pe pagina de web al EIZO:  
<http://www.eizoglobal.com>

## معلومات عن إعادة التدوير

عند التخلص من هذا المنتج، من الضروري تجميعه وإعادة تدويره وفقاً للقوانين المتبعة في بلدك لتقليل العبء المسلط على البيئة. عندما تتخلص من هذا المنتج، يرجى الاتصال بموزع أو طرف متنسب إليه في بلدك. عناوين الاتصال مدرجة في موقع ايزو EIZO ادناه على شبكة الانترنت.  
<http://www.eizoglobal.com>

## Geri Dönüşüm Bilgisi

Bu ürünün, atılacağı zaman, ülkenizin çevre kirliliğinin azaltılması konusundaki mevzuatına göre toplanması ve yeniden değerlendirilmesi gerekmektedir. Ürünü atacağınız zaman lütfen ülkenizdeki bir distribütör veya ilgili kuruluşla temasa geçiniz.

İrtibat adresleri aşağıdaki EIZO web sitesinde verilmiştir.  
<http://www.eizoglobal.com>



