



Installation Manual

RadiForce® MX216

Color LCD Monitor

Important

Please read this "Installation Manual", and "Instructions for Use" (separate volume) carefully to familiarize yourself with safe and effective usage.

-
- Refer to the "Instructions for Use" for information on the installation / connection of the monitor.
 - For the latest product information including the "Installation Manual", refer to our web site :
www.eizoglobal.com
-

This product has been adjusted specifically for use in the region to which it was originally shipped. If operated outside this region, the product may not perform as stated in the specifications.

No part of this manual may be reproduced, stored in a retrieval system, or transmitted, in any form or by any means, electronic, mechanical, or otherwise, without the prior written permission of EIZO Corporation. EIZO Corporation is under no obligation to hold any submitted material or information confidential unless prior arrangements are made pursuant to EIZO Corporation's receipt of said information. Although every effort has been made to ensure that this manual provides up-to-date information, please note that EIZO monitor specifications are subject to change without notice.

CONTENTS

CONTENTS	3	Chapter 5 Configuring Monitor Settings	19
Chapter 1 Basic Operation and Function List ... 4		5-1. Specifying the Language.....	19
1-1. Usage of Switches and Operation Guide... 4		5-2. Automatically Detecting the Input Signal ...	19
1-2. Basic Operation of the Setting Menu 5		5-3. Switching the Display Size	20
1-3. Function List.....	7	5-4. Setting the DisplayPort Version.....	20
Chapter 2 Adjusting the Screen	8	5-5. Setting the Image Display Orientation	21
2-1. Compatible Resolutions	8	5-6. Adjusting Brightness of the Power Switch Indicator	21
2-2. Setting the Input Signal	8	5-7. Skipping Unused Display Modes	21
2-3. Selecting Display Mode (CAL Switch Mode).....	9	5-8. Enabling or Disabling DisplayPort Communication in Power Saving Mode ...	22
2-4. Adjusting Brightness / Colors.....	10	5-9. Locking Operation Switches	22
● Adjustment items for each mode	10	5-10. Setting Whether to Display / Hide the Grayscale Warning	23
● Adjusting the brightness.....	10	5-11. Acquiring Life Estimation Data	23
● Enabling or disabling Hybrid Gamma PXL	11	5-12. Setting Whether to Display / Hide the EIZO Logo	24
● Adjusting the contrast	11	5-13. Viewing the Monitor Information	24
● Adjusting the color temperature.....	12	5-14. Resetting to Defaults.....	25
● Adjusting the gamma	12	● Resetting the color adjustment value.....	25
● Adjusting the hue	13	● Resetting all settings	25
● Adjusting the color saturation.....	13	Chapter 6 Troubleshooting	26
● Adjusting the gain.....	14	6-1. No Picture	26
2-5. Enabling or Disabling Sharpness Recovery (the Function of Correcting Image Clarity)	14	6-2. Imaging Problems.....	27
Chapter 3 Controlling Monitor Quality	15	6-3. Other Problems	28
3-1. Using the SelfCalibration Function	15	● Error Code Table	29
● Executing SelfCalibration.....	15	Chapter 7 Reference	30
● Checking the SelfCalibration results.....	16	7-1. Arm Installation Procedure.....	30
3-2. Using the Grayscale Check Function	16	7-2. How to Use USB Hub Function.....	31
● Performing Grayscale Check.....	16	7-3. Main Default Settings	32
● Checking the Grayscale Check results.....	17	Appendix	33
3-3. Setting Whether to Display / Hide Warnings or QC History	17	Trademark	33
Chapter 4 Using the Monitor for a Long Time ... 18		License	33
4-1. Setting the Power Saving Mode	18	LIMITED WARRANTY	34
		Recycling Information	35

Chapter 1 Basic Operation and Function List







1-1. Usage of Switches and Operation Guide

1. Displaying the operation guide

Touch any switch (except ).

The operation guide appears on the screen.



Display	Function
	Turns the power on or off.
	Displays the Setting menu. The Setting menu is used to configure advanced monitor settings.
	Switches display modes. For more information about how to switch display modes, see “2-3. Selecting Display Mode (CAL Switch Mode)” (page 9).
 	Selects an item.
	Applies the selected content.
	Cancels the selection.

2. Adjusting / setting

1. Touch a switch for the icon showing the item you want to set.

The menu appears.

2. Use each switch to configure the setting. If necessary, select  to apply the setting.

3. Exiting

Select  to exit the menu.

1-2. Basic Operation of the Setting Menu



1. Displaying the Setting menu

1. Select  from the operation guide.



The Setting menu appears.



Note



- To adjust or set "Administrator Settings" items, display the Setting menu according to the following procedure:
 1. Select  to turn off the monitor.
 2. While touching the leftmost switch (), touch  for more than two seconds to turn on the monitor.
"Administrator Settings" appears.

2. Adjusting / setting

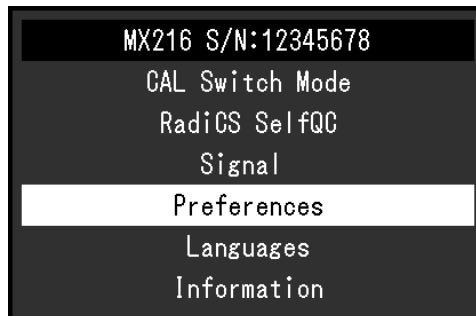
1. Select a menu to adjust / set using  , then select .



The advanced menu appears.

2. Select an item to adjust / set using  , then select .

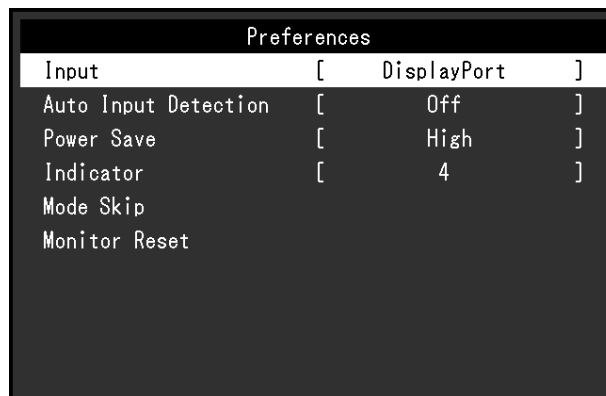

The Adjustment / Setting menu appears.

3. Perform adjustment/setting with **<** **>** or **^** **v**, and select **✓** to accept the changes.



Note

- The settings for "Administrator Settings" items are applied by selecting "Apply".



3. Exiting

Select **✕** several times to exit the Setting menu.

Note

- The menu for "Administrator Settings" items is exited by selecting "Apply".
-

1-3. Function List

The following table shows the items in the Setting menu.

Main menu	Item	Reference
CAL Switch Mode	Mode	"2-4. Adjusting Brightness / Colors" (page 10) Note • The functions that can be adjusted or set in "CAL Switch Mode" differ depending on the mode (see "Adjustment items for each mode" (page 10)).
	Brightness	
	Hybrid Gamma PXL	
	Contrast	
	Temperature	
	Gamma	
	Hue	
	Saturation	
	Gain	
	Reset	
RadiCS SelfQC	SelfCalibration	"3-1. Using the SelfCalibration Function" (page 15)
	Grayscale Check	"3-2. Using the Grayscale Check Function" (page 16)
	LEA	"5-11. Acquiring Life Estimation Data" (page 23)
	Settings	"3-3. Setting Whether to Display / Hide Warnings or QC History" (page 17)
Signal	Picture Expansion	"5-3. Switching the Display Size" (page 20)
Preferences	Input	"2-2. Setting the Input Signal" (page 8)
	Auto Input Detection	"5-2. Automatically Detecting the Input Signal" (page 19)
	Power Save	"4-1. Setting the Power Saving Mode" (page 18)
	Indicator	"5-6. Adjusting Brightness of the Power Switch Indicator" (page 21)
	Mode Skip	"5-7. Skipping Unused Display Modes" (page 21)
	Monitor Reset	"5-14. Resetting to Defaults" (page 25)
Languages		"5-1. Specifying the Language" (page 19)
Information		"5-13. Viewing the Monitor Information" (page 24)
Administrator Settings	On-Screen Logo	"5-12. Setting Whether to Display / Hide the EIZO Logo" (page 24)
	Key Lock	"5-9. Locking Operation Switches" (page 22)
	Image Rotation	"5-5. Setting the Image Display Orientation" (page 21)
	DP Power Save	"5-8. Enabling or Disabling DisplayPort Communication in Power Saving Mode" (page 22)
	Grayscale Warning	"5-10. Setting Whether to Display / Hide the Grayscale Warning" (page 23)
	Sharpness Recovery	"2-5. Enabling or Disabling Sharpness Recovery (the Function of Correcting Image Clarity)" (page 14)
	DisplayPort	"5-4. Setting the DisplayPort Version" (page 20)

Chapter 2 Adjusting the Screen

2-1. Compatible Resolutions

For information about the compatible resolutions of the monitor, see “Compatible Resolutions” in the Instructions for Use.

2-2. Setting the Input Signal

You can select an input signal to be displayed on the screen.

Procedure

1. Select “Preferences” from the Setting menu, then select .
2. Select “Input”, then .
3. Select “DisplayPort” or “DVI”, then select .

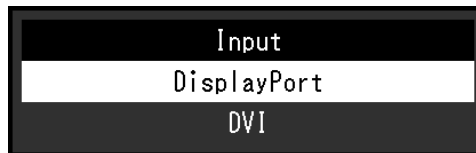

Attention

- If you turn the main power off and on again, the input signal is automatically detected regardless of the setting.
- If the PC that outputs the specified signal enters the power saving mode or is turned off when “Auto Input Detection” is set to “On”, any other available signal is displayed automatically. For details, refer to [“5-2. Automatically Detecting the Input Signal” \(page 19\)](#).

Note

- When the setting is complete, the input port names appear.

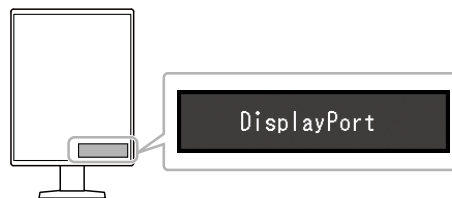

2-3. Selecting Display Mode (CAL Switch Mode)



The display mode can be selected according to the monitor application.

Display Modes

√: Can be calibrated



Mode	Purpose	
1-DICOM	Enables display using DICOM® Part 14-compliant grayscale characteristics.	√
2-CAL1	Displays the calibration status using calibration software.	√
3-CAL2		√
4-Custom	Select this mode to configure desired settings.	-
5-sRGB	Suitable for color matching with sRGB compatible peripherals.	-
6-Text	Suitable to display documents, spreadsheets, or other text.	-

Procedure

1. Touch any switch (except ).
2. Select  from the operation guide.
The Mode menu appears on the lower right.

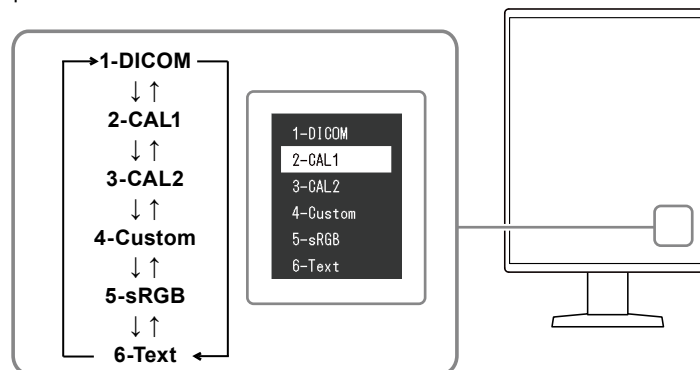
Example:



3. Modes are changed in sequence each time you select .
You can also select  or  to change modes when the Mode menu is being displayed.

Note

- The Setting menu and Mode menu cannot be displayed at the same time.

2-4. Adjusting Brightness / Colors

You can adjust brightness and colors for each mode, and save the settings.

Attention

- It takes about 15 minutes for the electrical parts in the product to become stable. Please wait 15 minutes or more after the monitor power has been turned on or the monitor has recovered from the power saving mode before performing adjustment.
- The same image may be observed in different colors on multiple monitors due to monitor-specific characteristics. Make fine color adjustment visually when matching colors on multiple monitors.

Note

- Use a value shown in "%" or "K" only for reference.

● Adjustment items for each mode

Adjustable functions differ depending on the mode type. (Functions that cannot be adjusted or set are not selectable.)

√: Adjustable -: Not adjustable

Function	CAL Switch Mode					
	1-DICOM	2-CAL1	3-CAL2	4-Custom	5-sRGB	6-Text
Brightness	√	√	√	√	√	√
Hybrid Gamma PXL	√	√	√	-	-	-
Contrast	-	-	-	√	√	√
Temperature	-	-	-	√	√	√
Gamma	-	-	-	√	√	√
Hue	-	-	-	√	√	√
Saturation	-	-	-	√	√	√
Gain	-	-	-	√	√	√
Reset	√	√	√	√	√	√

● Adjusting the brightness

The screen brightness is adjusted by changing the brightness of the backlight (light source from the LCD back panel).

Setting Range

0 to 100 %

Procedure

1. Select "CAL Switch Mode" from the Setting menu, then select .
2. Select "Brightness", then .
3. Specify the setting using or .
4. Select after completing the setting.

● Enabling or disabling Hybrid Gamma PXL

When the Hybrid Gamma PXL function is enabled, this product automatically differentiates between monochrome and color parts of the same image at a pixel level, and displays a color image using the gamma value for color image display.

Setting Range

On, Off

Procedure

1. Select "CAL Switch Mode" from the Setting menu, then select .
2. Select "Hybrid Gamma PXL", then .
3. Select "On" or "Off", then select .

● Adjusting the contrast

The brightness of the screen is adjusted by varying the video signal level.

Setting Range

0 to 100 %

Procedure

1. Select "CAL Switch Mode" from the Setting menu, then select .
2. Select "Contrast", then .
3. Specify the setting using or .
4. Select after completing the setting.

Note

- When the contrast is set to 100 %, all the color gradations are shown.
 - When adjusting the monitor, it is recommended to perform brightness adjustment, which does not lose gradation characteristics, prior to contrast adjustment.
 - Perform contrast adjustment in the following cases.
 - If the screen is too bright even when the brightness is set to 0 %
-

● Adjusting the color temperature

Adjust the color temperature.

The color temperature is normally used to express the hue of “White” and / or “Black” with a numerical value. The value is expressed in degrees “K” (Kelvin).

The screen becomes reddish at low color temperatures and bluish at high color temperatures, similar to the temperatures of a flame. The gain preset values are set for each color temperature setting value.

Setting Range

Native, 6000 K to 15000 K (in increments of 100 K), sRGB

Procedure

1. Select “CAL Switch Mode” from the Setting menu, then select .
2. Select “Temperature” then .
3. Specify the setting using or .
4. Select after completing the setting.

Note

- “Gain” allows you to perform more advanced adjustment (see [“Adjusting the gain” \(page 14\)](#)).
 - If set to “Native”, the image is displayed in the preset color of the monitor (Gain: 100 % for each RGB channel).
 - When gain is changed, the color temperature is changed to “User”.
-

● Adjusting the gamma

Adjust the gamma. While the brightness of the monitor varies depending on the input signal, the variation rate is not proportional to the input signal. Maintaining the balance between the input signal and brightness of the monitor is referred to as “Gamma correction”.

Setting Range

1.6 to 2.7, sRGB

Procedure

1. Select “CAL Switch Mode” from the Setting menu, then select .
2. Select “Gamma”, then .
3. Specify the setting using or .
4. Select after completing the setting.

Attention

- When “Hybrid Gamma PXL” is set to “On”, the gamma value for pixels that display a color image is fixed to a value appropriate for color image display (Fixed) regardless of the setting.
-

● Adjusting the hue

Adjust the hue.

Setting Range

-100 to 100

Procedure

1. Select “CAL Switch Mode” from the Setting menu, then select .
2. Select “Hue”, then .
3. Specify the setting using or .
4. Select after completing the setting.

Attention

- Using this function may prevent some color gradations from being able to be displayed.
-

● Adjusting the color saturation

Adjust the color saturation.

Setting Range

-100 to 100

Procedure

1. Select “CAL Switch Mode” from the Setting menu, then select .
2. Select “Saturation”, then .
3. Specify the setting using or .
4. Select after completing the setting.

Attention

- Using this function may prevent some color gradations from being able to be displayed.
-

Note

- The minimum value (-100) changes the screen to monochrome.
-







● Adjusting the gain

The brightness of each color component (red, green, and blue) is called “gain”. The hue of “white” can be changed by adjusting the gain.

Setting Range

0 to 100 %

Procedure

1. Select “CAL Switch Mode” from the Setting menu, then select .
2. Select “Gain”, then .
3. Select the color to be adjusted from “Red”, “Green”, and “Blue”, then select .
4. Specify the setting using  or .
5. Select  after completing the setting.

Attention

- Using this function may prevent some color gradations from being able to be displayed.







Note

- The gain value changes according to the color temperature.
 - When gain is changed, the color temperature is changed to “User”.
-

2-5. Enabling or Disabling Sharpness Recovery (the Function of Correcting Image Clarity)

EIZO’s unique technology called “Sharpness Recovery” displays images that are true to the original source data by correcting variations in the LCD panel.

Procedure

1. Select  to turn off the monitor.
2. While touching the leftmost switch (), touch  for more than two seconds to turn on the monitor.
3. Select “Sharpness Recovery” in “Administrator Settings”, then select .
4. Select “On” or “Off”, then select .
5. Select “Apply”, and then select .

Attention

- After changing the setting, perform a visual check according to the medical standards / guidelines.
-

Chapter 3 Controlling Monitor Quality

The monitor includes the Integrated Front Sensor, which enables you to perform calibration and Grayscale Check independently.

Note

- Calibration can be performed periodically by using the schedule function of RadiCS LE that is attached to the monitor. For more information about the setup procedure, refer to the RadiCS LE User's Manual (stored on the CD-ROM).
- RadiCS enables you to configure the schedule settings for Grayscale Check as well as for calibration. For more information about the setup procedure, refer to the RadiCS User's Manual.
- If you want to perform high-level quality control in compliance with medical standards / guidelines, use optional quality control software kit "RadiCS UX1".
- To adjust measurement results of the Integrated Front Sensor to those of an EIZO external sensor (UX1 or UX2 sensor), perform correlation between the Integrated Front Sensor and the external sensor using RadiCS / RadiCS LE. Periodical correlation allows you to maintain the measurement accuracy of the Integrated Front Sensor at a level equivalent to that of the external sensor.

3-1. Using the SelfCalibration Function

Execute SelfCalibration and view the latest results.

● Executing SelfCalibration

Procedure

1. Select "RadiCS SelfQC" from the Setting menu, then select .
 2. Select "SelfCalibration" for "RadiCS SelfQC", then select .
 3. Select "Execute", then .
- SelfCalibration is executed.

Attention

- If the power to the PC is turned off or the input signal switches while SelfCalibration is running, the execution will be canceled.
- After SelfCalibration is complete, perform Grayscale Check at the same room temperature and illuminance as those in the actual working environment.

Note

- The following items can be set by using RadiCS / RadiCS LE. For more information about the setup procedure, refer to the RadiCS / RadiCS LE User's Manual.
 - Calibration target
 - SelfCalibration schedule
 - If you have configured the schedule using RadiCS / RadiCS LE, the next execution schedule is displayed in the advanced menu.

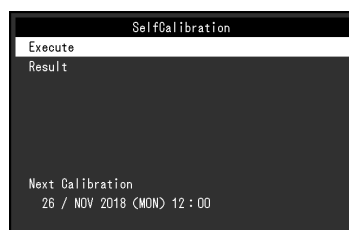

- The calibration target value can be confirmed by selecting the target mode in "CAL Switch mode" of the Setting menu.

● Checking the SelfCalibration results

Attention

- The results can be checked when "QC History" is set to "On" (see "3-3. Setting Whether to Display / Hide Warnings or QC History" (page 17)).

Procedure

1. Select "RadiCS SelfQC" from the Setting menu, then select .
2. Select "SelfCalibration", then .
3. Select "Result", then .
4. Select "DICOM", "CAL1", or "CAL2", then select .

The SelfCalibration results (such as Max. Error Rate, Last Time, and Error Code) are displayed.

3-2. Using the Grayscale Check Function

Perform Grayscale Check and view the latest results. Furthermore, if you have configured the schedule using RadiCS, the next execution schedule is displayed.

● Performing Grayscale Check

Attention

- Perform the Grayscale Check based on the actual color temperature and brightness of the working environment.

Procedure

1. Select "RadiCS SelfQC" from the Setting menu, then select .
2. Select "Grayscale Check", then .
3. Select "Execute", then .

Grayscale Check is executed.

Attention

- The determination value for Grayscale Check can be specified from RadiCS. Refer to the RadiCS User's Manual for details.
- The Grayscale Check schedule can be configured using RadiCS. For more information about the setup procedure, refer to the RadiCS User's Manual. If you have configured the schedule using RadiCS, the next execution schedule is displayed in the advanced menu.

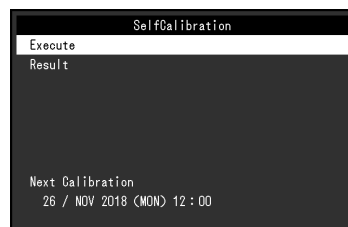

● Checking the Grayscale Check results

Attention

- The results can be checked when "QC History" is set to "On".
-

Procedure

1. Select "RadiCS SelfQC" from the Setting menu, then select .
2. Select "Grayscale Check", then .
3. Select "Result", then .
4. Select "DICOM", "CAL1", or "CAL2", then select .

Up to five past Grayscale Check results (Passed, Failed, Canceled, or Error) are displayed.

3-3. Setting Whether to Display / Hide Warnings or QC History

You can set whether to display or hide warnings related to "Failed" Grayscale Check results, or the execution results (QC History) of SelfCalibration, Grayscale Check, etc.

Procedure

1. Select "RadiCS SelfQC" from the Setting menu, then select .
2. Select "Settings", then .
3. Select "Warning" or "QC History".
4. Select "On" or "Off", then select .

Chapter 4 Using the Monitor for a Long Time

The monitor can be set to enter the power saving mode according to the PC status. The life of the monitor backlight can be extended by setting the monitor to enter the power saving mode when the monitor is not used.

4-1. Setting the Power Saving Mode

You can specify whether the monitor enters the power saving mode according to the PC status.

Procedure

1. Select "Preferences" from the Setting menu, then select .
2. Select "Power Save", then .
3. Select "High", "Low", or "Off", then select .

Setting	Function
High	Turns the backlight off. This provides the highest power saving effect.
Low	Sets the backlight to the lowest lighting level. The time until operation stabilizes after restoring from power saving mode can be reduced.
Off	Does not enable the power saving mode. The backlight lights up irrespective of the PC status. This setting may shorten the backlight life.

Attention

- When not using the monitor, you can turn off the main power supply or disconnect the power plug so that the power is cut completely.
- Devices connected to the USB upstream port and downstream port still work when the monitor is in the power saving mode or when the power is switched off using the power button () of the monitor. For this reason, power consumption of the monitor varies with connected devices even in the power saving mode.

Note

- When the signal input from the PC is no longer detected, a message appears notifying the user of the transition to power saving mode. The monitor enters power saving mode five seconds after the message appears.
- When power save is set to "High" or "Low", the status of the monitor can be confirmed by checking the color of the lamp on the power switch.

Power indicator	Monitor status	PC status
Green	Normal operation mode	On
Orange	Power saving mode	Off or power saving mode

Chapter 5 Configuring Monitor Settings

5-1. Specifying the Language

The language for the Setting menu and messages can be selected.

Selectable Languages

English, Germany, French, Spanish, Italian, Swedish, Japanese, Chinese (simplified), Chinese (traditional)

Procedure

1. Select “Languages” from the Setting menu, then select .
2. Select a language, then .

5-2. Automatically Detecting the Input Signal

This product automatically detects the connector through which a signal is input, and displays the signal on the screen.

Procedure

1. Select “Preferences” from the Setting menu, then select .
2. Select “Auto Input Detection”, then select .
3. Select “On” or “Off”, then select .

Setting	Function
On	Automatically detects the connector through which a signal is input, and displays the signal on the screen. If the PC that is outputting the signal displayed on the screen enters the power saving mode or is turned off when multiple PCs are connected, any other available signal is displayed automatically.
Off	Displays the selected input signal regardless of whether or not it is available. When you want to switch the input signal, see “2-2. Setting the Input Signal” (page 8).

Note

- If you turn the main power off and on again, the input signal is automatically detected regardless of the setting.

5-3. Switching the Display Size

You can set the size when displaying images at other than the recommended resolution.

Example:

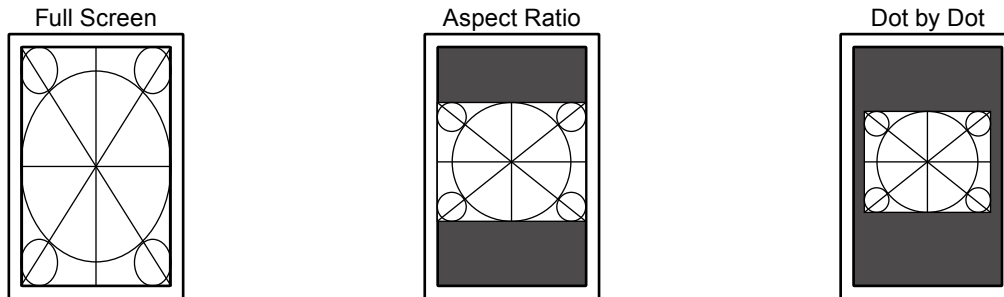

Procedure

1. Select “Signal” from the Setting menu, then select .
2. Select “Picture Expansion”, then .
3. Select “Full Screen”, “Aspect Ratio”, or “Dot by Dot”, and select .

Setting	Function
Full Screen	Enlarges the image to full-screen size. However, if the height-to-width ratio differs between the screen and image, the image may be distorted.
Aspect Ratio	Enlarges the image while its height-to-width ratio is maintained. However, if the height-to-width ratio differs between the screen and image, areas that display nothing may appear along the horizontal or vertical edges of the screen.
Dot by Dot	Displays the image at a size according to its resolution.



5-4. Setting the DisplayPort Version

You can set the DisplayPort version.

Attention

- When connecting the signal to other monitors using a daisy-chain connection, set to “Version 1.2”.
- When a PC is connected via the DisplayPort connector, the DisplayPort version may differ depending on the PC, and consequently the screen may not appear. In this case, try changing the following settings.



Procedure

1. Select  to turn off the monitor.
2. While touching the leftmost switch (), touch  for more than two seconds to turn on the monitor.
3. Select “DisplayPort” in “Administrator Settings”, then select .
4. Select “Version 1.1 10bit”, “Version 1.1 8bit”, or “Version 1.2”, then select .
5. Select “Apply”, and then select .

5-5. Setting the Image Display Orientation

This function allows you to change the image display orientation according to the monitor installation orientation.

Procedure

1. Select  to turn off the monitor.
2. While touching the leftmost switch (), touch  for more than two seconds to turn on the monitor.
3. Select "Image Rotation" in "Administrator Settings", then select .
4. Select "Portrait" or "Landscape", then select .

Setting	Monitor orientation
Portrait	Select this when the monitor is installed in portrait orientation.
Landscape	Select this when the monitor is installed in landscape orientation.

5. Select "Apply", and then select .



5-6. Adjusting Brightness of the Power Switch Indicator

The brightness of the power switch indicator (green) while the screen is displayed can be adjusted. The larger the set value, the brighter the power indicator lights up. On the other hand, the smaller the value, the darker it becomes. The "Off" setting turns off the power switch indicator.

Setting Range

1 to 7, Off

Procedure

1. Select "Preferences" from the Setting menu, then select .
2. Select "Indicator", then .
3. Specify the setting using  or .
4. When the setting is complete, select .

5-7. Skipping Unused Display Modes

This function allows you to skip certain display modes when selecting a mode.

Please use this function if you want to limit the modes to be displayed, or avoid changing the display status randomly.

Procedure

1. Select "Preferences" from the Setting menu, then select .
2. Select "Mode Skip", then .
3. Select a mode whose setting you want to change, then select .
4. Select "Skip" or "-", then select .

Attention

- Not all modes can be disabled (skipped). Set at least one mode to "-".



5-8. Enabling or Disabling DisplayPort Communication in Power Saving Mode

Connecting a PC to the DisplayPort connector enables DisplayPort communication, and thus consumes high power even in the power saving mode. The communication can be disabled by setting “DP Power Save” to “On”. This reduces power consumption in the power saving mode.

Attention

- If “On” is selected, window and icon positions may shift when the monitor is powered back on or returned from the power saving mode. In such cases, set this function to “Off”.



Procedure

1. Select  to turn off the monitor.
2. While touching the leftmost switch (), touch  for more than two seconds to turn on the monitor.
3. Select “DP Power Save” in “Administrator Settings”, then select .
4. Select “On” or “Off”, then select .
5. Select “Apply”, and then select .

5-9. Locking Operation Switches

Adjusted or set states can be made unchangeable.

Procedure

1. Touch  to turn off the monitor.
2. While touching the leftmost switch (), touch  for more than two seconds to turn on the monitor.
3. Select “Key Lock” in “Administrator Settings”, then select .
4. Select “Off”, “Menu”, or “All”, then select .

Setup item	Lockable switches
Off	None (All switches are enabled.)
Menu	Adjust or set using the Setting menu.
All	All switches except 

5. Select “Apply”, and then select .

Note

- After calibration is performed using RadiCS / RadiCS LE, “Menu” is selected.

5-10. Setting Whether to Display / Hide the Grayscale



Warning

You can specify whether to display the Grayscale Display Error message to indicate that a 6-bit (64-grayscale) signal has been detected when the DisplayPort signal is input at the recommended resolution. If the error message appears, please turn off the main power, and then turn it on again.

Attention

- Always use with this set to "ON" (the default setting is "ON").
 - Set this to "OFF" only when using 6bit (64 grayscale) display.
-

Procedure

1. Select  to turn off the monitor.
2. While touching the leftmost switch (), touch  for more than two seconds to turn on the monitor.
3. Select "Grayscale Warning" in "Administrator Settings", then select .
4. Select "On" or "Off", then select .
5. Select "Apply", and then select .

5-11. Acquiring Life Estimation Data

You can acquire data required to estimate the monitor's lifespan. The life estimation result based on the acquired data can be confirmed using RadiCS / RadiCS LE.

Note

- Data is collected every 100 hours.
 - If you selected "Power Save" and 100 hours have elapsed, the data collection process runs when the monitor enters the power saving mode or the power is turned off.
 - If "Routine" or "Power Save" is selected, the Integrated Front Sensor starts measurement at the time of data collection. If "Off" is selected, measurement using the Integrated Front Sensor is not performed at the time of data collection.
 - The collected data is saved at the following timings:
 - 500, 1000, 2000, 4000, 7000, 10000, 15000, 20000, 25000, and 30000 hours.
-



Procedure

1. Select "RadiCS SelfQC" from the Setting menu, then select .
2. Select "LEA" for "RadiCS SelfQC", then select .
3. Select "Meas. Frequency".
4. Select "Power Save", "Routine", or "Off", then select .

5-12. Setting Whether to Display / Hide the EIZO Logo

You can select whether to display or hide the EIZO logo when the monitor starts.

Procedure

1. Touch  to turn off the monitor.
2. While touching the leftmost switch (), touch  for more than two seconds to turn on the monitor.
3. Select “On-Screen Logo” in “Administrator Settings”, then select .
4. Select “On” or “Off”, then select .
5. Select “Apply”, and then select .

5-13. Viewing the Monitor Information

View information related to the input signals that are currently displayed and the monitor.

Procedure

1. Select “Information” from the Setting menu, then select .
Input signal information, model name, serial number, firmware version, and usage time are displayed.
The asset tag number is only displayed when it has been set using RadiCS / RadiCS LE.

Example:

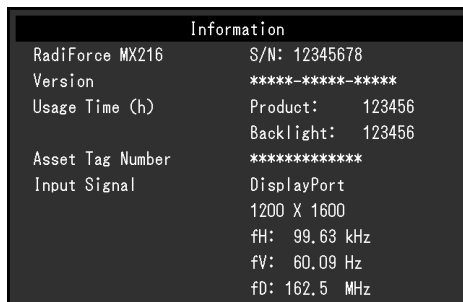

Information	
RadiForce MX216	S/N: 12345678
Version	****-****-****
Usage Time (h)	Product: 123456 Backlight: 123456
Asset Tag Number	*****
Input Signal	DisplayPort 1200 X 1600 fH: 99.63 kHz fV: 60.09 Hz fD: 162.5 MHz

Attention

- The usage time may not be "0" at the time of your purchase because inspections and other processes had been carried out on the monitor before it was shipped from the factory.

5-14. Resetting to Defaults

There are two different reset functions: One that only resets the color adjustments to default settings, and the other that resets all settings to defaults.

Attention

- The previous settings cannot be recovered after they were reset to defaults.

Note

- For information about default settings, see [“7-3. Main Default Settings” \(page 32\)](#).
-

● Resetting the color adjustment value

Only the adjustment value for the currently selected mode is reset to the default setting.

Procedure

1. Select “CAL Switch Mode” from the Setting menu, then select .
2. Select “Reset”, then .
3. Select “OK”, then .

The color adjustment value reverts to the default setting.

● Resetting all settings

Restore all settings to their default values (except for “Input” and “Administrator Settings”).





Procedure

1. Select “Preferences” from the Setting menu, then select .
2. Select “Monitor Reset”, then select .
3. Select “OK”, then select .

All settings except for “Input” and “Administrator Settings” are reset to defaults.

Chapter 6 Troubleshooting

6-1. No Picture

Problem	Possible cause and remedy
<p>1. No picture</p> <ul style="list-style-type: none"> Power switch indicator does not light up. <hr/> <ul style="list-style-type: none"> Power switch indicator lights up: Green <hr/> <ul style="list-style-type: none"> Power switch indicator lights up: Orange <hr/> <ul style="list-style-type: none"> Power switch indicator blinks: Orange, Green 	<ul style="list-style-type: none"> Check whether the power cord is connected properly. Turn the main power switch on. Touch . Turn off the main power, and then turn it on again. <hr/> <ul style="list-style-type: none"> Increase “Brightness”, “Contrast”, or “Gain” in the Setting menu (see “2-4. Adjusting Brightness / Colors” (page 10)). Turn off the main power, and then turn it on again. <hr/> <ul style="list-style-type: none"> Try switching the input signal (see “2-2. Setting the Input Signal” (page 8)). Move the mouse or press any key on the keyboard. Check whether the PC is turned on. When inputting the DisplayPort signal, connect to .  is used for output when a daisy-chain connection is set up. Turn off the main power, and then turn it on again. <hr/> <ul style="list-style-type: none"> Connect via the signal cable specified by EIZO. Turn off the main power, and then turn it on again. If the signal cable is connected to DisplayPort, try switching the DisplayPort version (see “5-4. Setting the DisplayPort Version” (page 20)).
<p>2. The message below appears.</p> <ul style="list-style-type: none"> This message appears when no signal is input. Example: <div data-bbox="256 1218 655 1361" style="border: 1px solid black; background-color: black; color: white; padding: 10px; text-align: center;"> <p>DisplayPort No Signal</p> </div> <hr/> <ul style="list-style-type: none"> The message indicates that the input signal is out of the specified frequency range. Example: <div data-bbox="256 1608 655 1751" style="border: 1px solid black; background-color: black; color: white; padding: 10px; text-align: center;"> <p>DisplayPort Signal Error</p> </div>	<p>This message appears when the signal is not input correctly even though the monitor is functioning properly.</p> <hr/> <ul style="list-style-type: none"> The message shown left may appear, because some PCs do not output the signal immediately after power-on. Check whether the PC is turned on. Check whether the signal cable is connected properly. Try switching the input signal (see “2-2. Setting the Input Signal” (page 8)). If the signal cable is connected to DisplayPort, try switching the DisplayPort version (see “5-4. Setting the DisplayPort Version” (page 20)). When inputting the DisplayPort signal, connect to .  is used for output when a daisy-chain connection is set up. Turn off the main power, and then turn it on again. <hr/> <ul style="list-style-type: none"> Check whether the PC is configured to meet the resolution and vertical scan frequency requirements of the monitor (see “Compatible Resolutions” in the Instructions for Use). Reboot the PC. Select an appropriate setting using the graphics board’s utility. For more information, refer to the User’s Manual of the graphics board.

6-2. Imaging Problems

Problem	Possible cause and remedy
1. The screen is too bright or too dark.	<ul style="list-style-type: none">• Use “Brightness” or “Contrast” in the Setting menu to adjust it. (The LCD monitor backlight has a limited life span. When the screen becomes dark or begins to flicker, contact your local EIZO representative.)
2. Text is blurred	<ul style="list-style-type: none">• Check whether the PC is configured to meet the resolution and vertical scan frequency requirements of the monitor (see “Compatible Resolutions” in the Instructions for Use).
3. Afterimages appear	<ul style="list-style-type: none">• Afterimages are particular to LCD monitors. Avoid displaying the same image for a long time.• Use the screen saver or power saving function to avoid displaying the same image for extended periods of time.• An afterimage may appear even after a short time period has elapsed depending on the displayed image. If this occurs, changing the image or leaving the power off for a few hours may solve the problem.
4. Green / red / blue / white dots or dark dots remain on the screen.	<ul style="list-style-type: none">• This is due to LCD panel characteristics and not a malfunction.
5. Interference patterns or traces created when selecting panels remain on the screen.	<ul style="list-style-type: none">• Display a white or black image over the entire screen. The symptom may disappear.

6-3. Other Problems

Problem	Possible cause and remedy
1. The Setting menu does not appear.	<ul style="list-style-type: none"> Check whether the operation switch lock function has been activated (see “5-9. Locking Operation Switches” (page 22)).
2. The Mode menu does not appear.	<ul style="list-style-type: none"> Check whether the operation switch lock function has been activated (see “5-9. Locking Operation Switches” (page 22)).
3. The operation switches do not work.	<ul style="list-style-type: none"> Check whether the operation switch lock function has been activated (see “5-9. Locking Operation Switches” (page 22)). Check whether there are any water droplets or foreign objects on the switch surface. Gently wipe the switch surface and try operating the switches again with dry hands. Are you wearing gloves? If so, remove the gloves and try operating the switches again with dry hands.
4. The monitor connected using the USB cable is not detected or the USB device (peripheral) connected to the monitor does not work.	<ul style="list-style-type: none"> Check whether the USB cable is connected correctly (see “7-2. How to Use USB Hub Function” (page 31)). Try changing to a different USB port on the PC. Try changing to a different USB port on the monitor. Reboot the PC. If the peripheral works normally when directly connected to the PC, contact your dealer or local EIZO representative. Check whether the PC and OS are USB compliant. (For USB compliance of the respective devices, consult their manufacturers.) Check the PC’s BIOS setting for USB when using Windows. (Refer to the manual of the PC for details.)
5. Power is turned off during operation, and the screen does not appear.	<ul style="list-style-type: none"> The monitor turns off automatically when the internal temperature is excessively high. If you switch the power on in a high-temperature state, the monitor turns off again in one minute. Change the installation location or environment, wait for a few minutes, and then turn the power on again. <ul style="list-style-type: none"> - Is the ventilation slot blocked? - Are there any hot objects near the monitor? If the power still does not turn on even after changing the location or environment, contact your local EIZO representative. <p>Attention</p> <ul style="list-style-type: none"> Do not block the monitor’s ventilation slot, nor use the monitor in a poorly ventilated location.
6. The Integrated Front Sensor stays out.	<ul style="list-style-type: none"> Turn off the main power, and then turn it on again.
7. SelfCalibration / Grayscale Check fails.	<ul style="list-style-type: none"> Refer to the following error code table. <p>Attention</p> <ul style="list-style-type: none"> Do not touch the Integrated Front Sensor.
8. The SelfCalibration / Grayscale Check history does not display the clock time correctly.	<ul style="list-style-type: none"> Perform monitor detection using RadiCS / RadiCS LE. For details, refer to the RadiCS / RadiCS LE User’s Manual.

● Error Code Table

Error Code	Description
****50	<ul style="list-style-type: none">• The maximum brightness of the monitor may be lower than the target brightness.• Try reducing the target brightness.
****52	<ul style="list-style-type: none">• The minimum brightness of the monitor may be higher than the target minimum brightness.• Try increasing the target minimum brightness.
****05	<ul style="list-style-type: none">• The sensor may not have worked correctly.• Turn off the main power, wait for a few minutes, turn the power back on, and then run SelfCalibration / Grayscale Check again.
****20 ****21	<ul style="list-style-type: none">• The sensor may not have worked correctly.• Check whether there is any foreign object near the sensor.• Run SelfCalibration / Grayscale Check again.

Chapter 7 Reference

7-1. Arm Installation Procedure

An optional arm (or an optional stand) can be attached by removing the stand section. Please refer to our web site for the supported optional arm (or optional stand). www.eizoglobal.com

Attention

- When attaching an arm or stand, follow the instructions of the respective User's Manual.
- When using another manufacturer's arm or stand, confirm the following in advance and select one conforming to the VESA standard.
 - Clearance between the screw holes: 100 mm × 100 mm
 - VESA mount of the arm or stand, external dimensions: 122 mm x 122 mm or less
 - Strong enough to support weight of the monitor unit (excluding the stand) and attachments such as cables.
- When using another manufacturer's arm or stand, use the following screws to secure it.
 - Screws fixing the stand to the monitor
- When using an arm or stand, attach it to meet the following tilt angles of the monitor.
 - Up 45°, down 45° (when the monitor is in portrait orientation, or when it is rotated 90° counterclockwise to a landscape orientation)
- Connect the cables after attaching an arm or stand.
- Do not move the removed stand up and down. Doing so may result in injury or device damage.
- The monitor, arm, and stand are heavy. Dropping them may result in injury or equipment damage.
- Periodically check the tightness of the screws. If not sufficiently tight, the monitor may detach from the arm, which may result in injury or equipment damage.

Attachment procedure

1. In order to prevent the panel surface from being damaged, lay the monitor on a soft cloth spread on a stable surface with the panel surface facing down.

2. Remove the stand.

Prepare a screwdriver. Using a screwdriver, remove the screws (four) securing the unit and the stand.

3. Attach the arm or stand to the monitor.

Use the screws that you removed in step 2 to attach the arm (or stand) to the monitor.

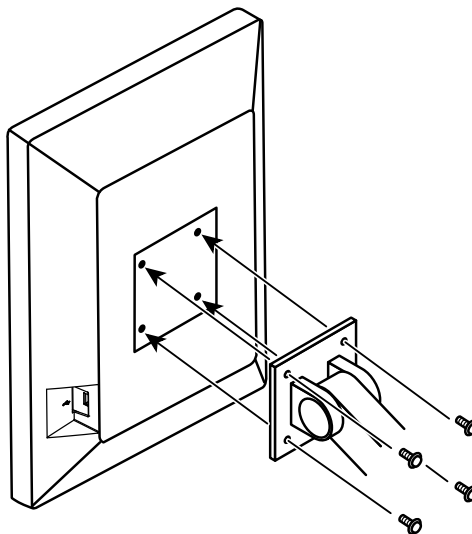

7-2. How to Use USB Hub Function

This monitor is equipped with a USB hub. Connected to a PC compatible with USB or another monitor with a USB hub, this monitor functions as a USB hub allowing connection to peripheral USB devices.

Connection procedure

1. Connect the supplied USB cable between the USB downstream port of a PC (or monitor that has a USB hub) and the monitor's USB upstream port.
2. Connect the peripheral USB device to the USB downstream port of the monitor.

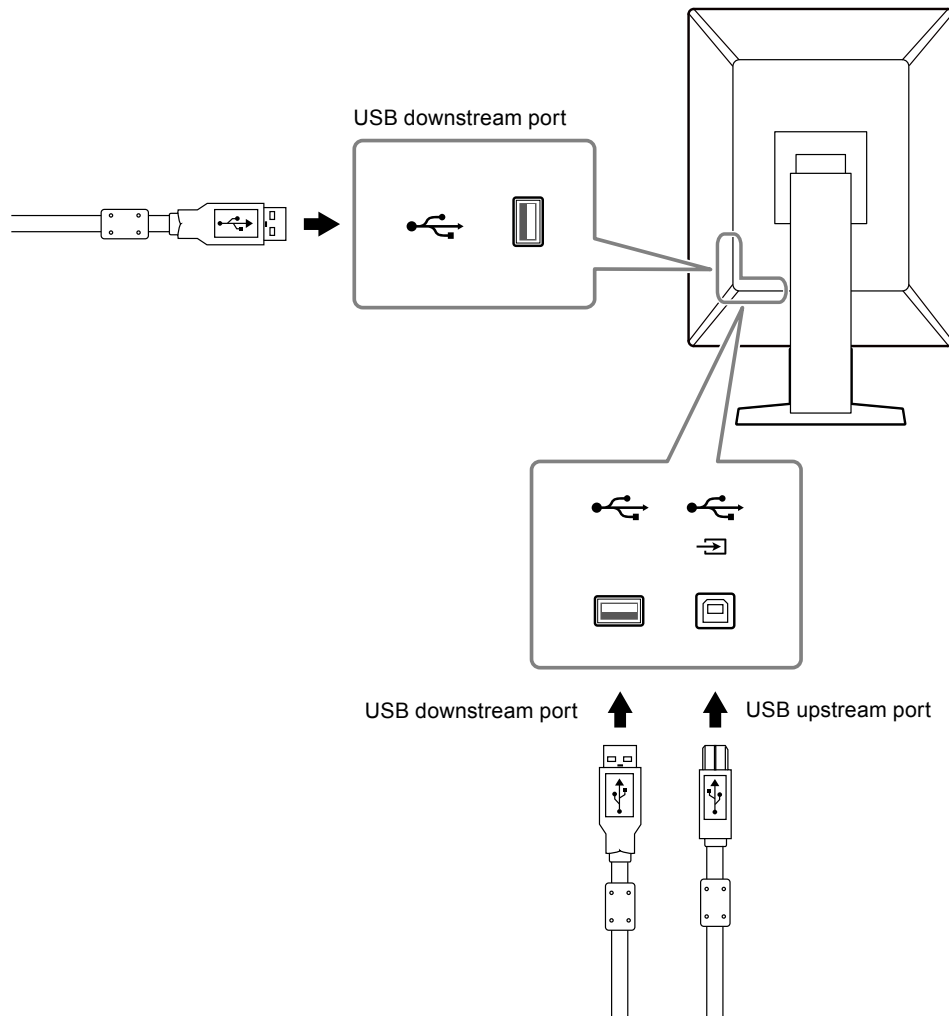

Attention

- When the main power switch is Off, devices connected to the USB port will not operate.

7-3. Main Default Settings

CAL Switch Mode: Factory default display setting is “1-DICOM”.

Mode	Brightness	Temperature	Gamma value	Hybrid Gamma PXL
1-DICOM	270 cd/m ²	7500 K	DICOM GSDF	Off
2-CAL1	270 cd/m ²	7500 K	2.2	Off
3-CAL2	180 cd/m ²	7500 K	DICOM GSDF	Off
4-Custom	Approx. 180 cd/m ²	7500 K	2.2	- (Disable)
5-sRGB	Approx. 180 cd/m ²	sRGB	sRGB	- (Disable)
6-Text	Approx. 100 cd/m ²	6500 K	2.2	- (Disable)

Others

LEA	Power Save
Warning	Off
QC History	On
Picture Expansion	Dot by Dot
Input	DisplayPort ^{*1}
Auto Input Detection	Off
Power Save	High
Indicator	4
Mode Skip	- (Display all)
Language	English
On-Screen Logo	Off ^{*1}
Key Lock	Off ^{*1}
Image Rotation	Portrait ^{*1}
DP Power Save	Off ^{*1}
Grayscale Warning	On ^{*1}
Sharpness Recovery	On ^{*1}
DisplayPort	Version 1.2 ^{*1}

*1 These menus cannot be initialized by executing "Monitor Reset" (see [“Resetting all settings” \(page 25\)](#)).

Appendix

Trademark

The terms HDMI and HDMI High-Definition Multimedia Interface, and the HDMI Logo are trademarks or registered trademarks of HDMI Licensing, LLC in the United States and other countries.

The DisplayPort Compliance Logo and VESA are registered trademarks of the Video Electronics Standards Association.

The SuperSpeed USB Trident Logo is a registered trademark of USB Implementers Forum, Inc.



The USB Power Delivery Trident Logos are trademarks of USB Implementers Forum, Inc.



DICOM is the registered trademark of the National Electrical Manufacturers Association for its standards publications relating to digital communications of medical information.

Kensington and Microsaver are registered trademarks of ACCO Brands Corporation.

Thunderbolt is a trademark of Intel Corporation in the United States and/or other countries.

Microsoft and Windows are registered trademarks of Microsoft Corporation in the United States and other countries.

Adobe is a registered trademark of Adobe Systems Incorporated in the United States and other countries.

Apple, macOS, Mac OS, OS X, Macintosh and ColorSync are registered trademarks of Apple Inc.

EIZO, the EIZO Logo, ColorEdge, CuratOR, DuraVision, FlexScan, FORIS, RadiCS, RadiForce, RadiNET, Raptor and ScreenManager are registered trademarks of EIZO Corporation in Japan and other countries.

ColorEdge Tablet Controller, ColorNavigator, EcoView NET, EIZO EasyPIX, EIZO Monitor Configurator, EIZO ScreenSlicer, G-Ignition, i•Sound, Quick Color Match, RadiLight, Re/Vue, SafeGuard, Screen Administrator, Screen InStyle, ScreenCleaner and UniColor Pro are trademarks of EIZO Corporation.

All other company and product names are trademarks or registered trademarks of their respective owners.

License

The bitmap font used for this product is designed by Ricoh Industrial Solutions Inc.

LIMITED WARRANTY

EIZO Corporation (hereinafter referred to as “EIZO”) and distributors authorized by EIZO (hereinafter referred to as the “Distributors”) warrant, subject to and in accordance with the terms of this limited warranty (hereinafter referred to as the “Warranty”), to the original purchaser (hereinafter referred to as the “Original Purchaser”) who purchased the product specified in this document (hereinafter referred to as the “Product”) from EIZO or Distributors, that EIZO and Distributors shall, at their sole discretion, either repair or replace the Product at no charge if the Original Purchaser becomes aware within the Warranty Period (defined below) that (i) the Product malfunctions or is damaged in the course of normal use of the Product in accordance with the description in the instruction manual of the Product (hereinafter referred to as the “User’s Manual”), or (ii) the LCD panel and brightness of the Product cannot maintain the recommended brightness specified in the User’s Manual in the course of normal use of the Product in accordance with the description of the User’s Manual.

The period of this Warranty is five (5) years from the date of purchase of the Product (hereinafter referred to as the “Warranty Period”). However, the brightness of the Product shall be warranted only if the Product has been used within the recommended brightness described in the User’s Manual. The Warranty Period for the brightness is also limited to five (5) years from the date of purchase of the Product subject to the usage time being less than or equal to 10,000 hours (the brightness is 270 cd/m² and color temperature is 7500K). EIZO and Distributors shall bear no liability or obligation with regard to the Product in relation to the Original Purchaser or any third parties other than as provided under this Warranty.

EIZO and Distributors will cease to hold or store any parts (excluding design parts) of the Product upon expiration of seven (7) years after the production of the Product is discontinued. In repairing the monitor, EIZO and Distributors will use renewal parts which comply with our QC standards. If the unit cannot be repaired due to its condition or the stockout of a relevant part, EIZO and Distributors may offer the replacement by a product with equivalent performance instead of repairing it.

The Warranty is valid only in the countries or territories where the Distributors are located. The Warranty does not restrict any legal rights of the Original Purchaser.

Notwithstanding any other provision of this Warranty, EIZO and Distributors shall have no obligation under this Warranty whatsoever in any of the cases as set forth below:

- (a) Any defect of the Product caused by freight damage, modification, alteration, abuse, misuse, accident, incorrect installation, disaster, adherent dust, faulty maintenance and/or improper repair by third party other than EIZO and Distributors;
- (b) Any incompatibility of the Product due to possible technical innovations and/or regulations;
- (c) Any deterioration of the sensor, including measurement value of the sensor;
- (d) Any defect of the Product caused by external equipments;
- (e) Any defect of the Product caused by the use under environmental conditions other than EIZO and Distributors’ estimation;
- (f) Any deterioration of the attachments of the Product (e.g. cables, User’s Manual, CD-ROM, etc.);
- (g) Any deterioration of the consumables, and/or accessories of the Product (e.g. batteries, remote controller, touch pen, etc.);
- (h) Any deformation, discoloration, and/or warp of the exterior of the Product including that of the surface of the LCD panel;
- (i) Any defect of the Product caused by placement in a location where it may be affected by strong vibration or shocks;
- (j) Any defect of the Product caused by liquid leaking from battery;
- (k) Any deterioration of the Product caused by the use at higher brightness than the recommended brightness described in the User’s Manual;
- (l) Any deterioration of display performance caused by the deterioration of expendable parts such as the LCD panel and/or backlight, etc. (e.g. changes in brightness uniformity, changes in color, changes in color uniformity, defects in pixels including burnt pixels, etc.);
- (m) Any deterioration or malfunction of the cooling fan caused by adherent dust.

To obtain service under the Warranty, the Original Purchaser must deliver the Product, freight prepaid, in its original package or other adequate package affording an equal degree of protection, assuming the risk of damage and/or loss in transit, to the local Distributor. The Original Purchaser must present proof of purchase of the Product and the date of such purchase when requesting services under the Warranty.

The Warranty Period for any replaced and/or repaired product under this Warranty shall expire at the end of the original Warranty Period.

EIZO OR DISTRIBUTORS ARE NOT RESPONSIBLE FOR ANY DAMAGE TO, OR LOSS OF, DATA OR OTHER INFORMATION STORED IN ANY MEDIA OR ANY PART OF ANY PRODUCT RETURNED TO EIZO OR DISTRIBUTORS FOR REPAIR.

EIZO AND DISTRIBUTORS MAKE NO FURTHER WARRANTIES, EXPRESSED OR IMPLIED, WITH RESPECT TO THE PRODUCT AND ITS QUALITY, PERFORMANCE, MERCHANTABILITY OR FITNESS FOR ANY PARTICULAR USE. IN NO EVENT SHALL EIZO OR DISTRIBUTORS BE LIABLE FOR ANY INCIDENTAL, INDIRECT, SPECIAL, CONSEQUENTIAL OR OTHER DAMAGE WHATSOEVER (INCLUDING, WITHOUT LIMITATION, DAMAGES FOR LOSS OF PROFIT, BUSINESS INTERRUPTION, LOSS OF BUSINESS INFORMATION, OR ANY OTHER PECUNIARY LOSS) ARISING OUT OF THE USE OR INABILITY TO USE THE PRODUCT OR IN ANY CONNECTION WITH THE PRODUCT, WHETHER BASED ON CONTRACT, TORT, NEGLIGENCE, STRICT LIABILITY OR OTHERWISE, EVEN IF EIZO OR DISTRIBUTORS HAVE BEEN ADVISED OF THE POSSIBILITY OF SUCH DAMAGES. THIS EXCLUSION ALSO INCLUDES ANY LIABILITY WHICH MAY ARISE OUT OF THIRD PARTY CLAIMS AGAINST THE ORIGINAL PURCHASER. THE ESSENCE OF THIS PROVISION IS TO LIMIT THE POTENTIAL LIABILITY OF EIZO AND DISTRIBUTORS ARISING OUT OF THIS LIMITED WARRANTY AND/OR SALES.

Recycling Information

Recycling Information

This product, when disposed of, is supposed to be collected and recycled according to your country's legislation to reduce environmental burden. When you dispose of this product, please contact a distributor or an affiliate in your country.

The contact addressees are listed on the EIZO website below.

www.eizoglobal.com

For recycling information for customers in Switzerland, please refer to the following website.

www.swico.ch

Informationen zum Thema Recycling

Dieses Produkt muss gemäß den Vorschriften Ihres Landes zur Entlastung der Umwelt recyclet werden. Wenden Sie sich bei der Entsorgung dieses Produkts an einen Verteiler oder eine Tochtergesellschaft in Ihrem Land.

Die Adressen zur Kontaktaufnahme sind auf der unten angegebenen Website von EIZO aufgeführt.

www.eizoglobal.com

Kunden in der Schweiz entnehmen Informationen zum Recycling der folgenden Website:

www.swico.ch

Informations sur le recyclage

Ce produit doit être jeté aux points de collecte prévus à cet effet et recyclé conformément à la législation de votre pays, afin de réduire l'impact sur l'environnement. Lorsque vous jetez ce produit, veuillez contacter un distributeur ou une société affiliée de votre pays.

Les adresses des distributeurs sont répertoriées sur le site Web EIZO ci-dessous.

www.eizoglobal.com

Pour les clients en Suisse, veuillez consulter le site Web suivant afin d'obtenir des informations sur le recyclage.

www.swico.ch

Información sobre reciclaje

Este producto debe desecharse y reciclarse según la legislación del país para reducir el impacto medioambiental.

Cuando desee deshacerse de este producto, póngase en contacto con un distribuidor o una filial de su país.

Encontrará las direcciones de contacto en el sitio web de EIZO que se indica a continuación.

www.eizoglobal.com

Informazioni sul riciclaggio

Per lo smaltimento e il riciclaggio del presente prodotto, attenersi alle normative vigenti nel proprio paese per ridurre l'impatto ambientale. Per lo smaltimento, rivolgersi ad un distributore o un affiliato presenti nel proprio paese.

Gli indirizzi sono elencati nel sito Web EIZO riportato di seguito.

www.eizoglobal.com

Per informazioni sul riciclaggio per i clienti in Svizzera, consultare il sito Web riportato di seguito.

www.swico.ch

Återvinningsinformation

När denna produkt kasseras ska den hanteras och återvinnas enligt landets föreskrifter för att reducera miljöpåverkan.

När du kasserar produkten ska du kontakta en distributör eller representant i ditt land.

Kontaktadresserna listas på EIZO-webbplatsen nedan.

www.eizoglobal.com

Πληροφορίες ανακύκλωσης

Το προϊόν αυτό, όταν απορρίπτεται, πρέπει να συλλέγεται και να ανακυκλώνεται σύμφωνα με τη νομοθεσία της χώρας σας έτσι ώστε να μην επιβαρύνει το περιβάλλον. Για να απορρίψετε το προϊόν, επικοινωνήστε με έναν αντιπρόσωπο ή μια θυγατρική εταιρεία στη χώρα σας.

Οι διευθύνσεις επικοινωνίας αναγράφονται στην τοποθεσία web της EIZO παρακάτω.

www.eizoglobal.com

Сведения по утилизации

По истечении срока службы данного продукта его следует принести на сборный пункт и утилизировать в соответствии с действующими предписаниями в вашей стране, чтобы уменьшить вредное воздействие на окружающую среду. Прежде чем выбросить данный продукт, обратитесь к дистрибьютору или в местное представительство компании в вашей стране.

Контактные адреса можно найти на веб-узле EIZO.

www.eizoglobal.com

Informatie over recycling

Wanneer u dit product wilt weggooien, moet het uit milieu-overwegingen worden verzameld en gerecycled volgens de betreffende wetgeving van uw land. Wanneer u dit product wilt weggooien, moet u contact opnemen met een distributeur of een partner in uw land.

De contactadressen worden vermeld op de volgende EIZO-website.

www.eizoglobal.com

Informação sobre reciclagem

Este produto, quando o deitar fora, deve ser recolhido e reciclado de acordo com a legislação do seu país para reduzir a poluição. Quando deitar fora este produto, contacte um distribuidor ou uma filial no seu país.

Os endereços de contacto estão listados no website do EIZO, abaixo.

www.eizoglobal.com

Oplysninger om genbrug

Denne produkt forventes ved bortskaffelse at blive indsamlet og genbrugt i overensstemmelse med lovgivningen i dit land for at reducere belastningen af miljøet. Når du bortskaffer denne produkt, skal du kontakte en distributør eller et tilknyttet selskab i dit land.

Adresserne på kontaktpersonerne er angivet på EIZO's websted nedenfor.

www.eizoglobal.com

Kierrätystä koskevia tietoja

Tuote tulee hävittää kierrätämällä maan lainsäädännön mukaisesti ympäristön kuormittumisen vähentämiseksi. Kun hävität tuotteen, ota yhteyttä jälleenmyyjään tai tytäryhtiöön maassasi.

Yhteystiedot löytyvät EIZOn Internet-sivustolta.

www.eizoglobal.com

Wykorzystanie surowców wtórnych

Ten produkt po zużyciu powinien być zbierany i przetwarzany zgodnie z krajowymi przepisami dotyczącymi ochrony środowiska. Wyrzucając ten produkt, należy skontaktować się z lokalnym dystrybutorem lub partnerem. Adresy kontaktowe można znaleźć we wskazanej poniżej witrynie internetowej firmy EIZO.

www.eizoglobal.com

Informace o recyklaci

Při likvidaci produktu musí být produkt vyzvednut a recyklován podle zákonů příslušné země, aby nedocházelo k zatěžování životního prostředí. Zbavujete-li se produktu, kontaktujte distributora nebo pobočku ve své zemi. Kontaktní adresy jsou uvedeny na následující webové stránce společnosti EIZO.

www.eizoglobal.com

Ringlussevõtu alane teave

Keskkonnakoormuse vähendamiseks tuleks kasutatud tooted kokku koguda ja võtta ringlusse vastavalt teie riigi seadustele. Kui kõrvaldate käesoleva toote, võtke palun ühendust turustaja või filiaaliga oma riigis.

Kontaktisikud on toodud EIZO veebilehel järgmisel aadressil:

www.eizoglobal.com

Újrahasznosítási információ

Jelen terméket, amikor eldobjuk, az illető ország törvényei alapján kell összegyűjteni és újrahasznosítani, hogy csökkentsük a környezet terhelését. Amikor ezt a terméket eldobja, kérjük lépjen kapcsolatba egy országon belüli forgalmazóval vagy társvállalkozással.

A kapcsolat címei az EIZO alábbi weboldalán található felsorolva:

www.eizoglobal.com

Podatki o recikliranju

Ob koncu uporabe odslužen izdelek izročite na zbirno mesto za recikliranje v skladu z okoljevarstveno zakonodajo vaše države. Prosimo, da se pri odstranjevanju izdelka obrnete na lokalnega distributerja ali podružnico.

Kontaktni naslovi so objavljeni na spodaj navedenih spletnih straneh EIZO:

www.eizoglobal.com

Informácie o recyklácii

Pri likvidácii musí byť tento výrobok recyklovaný v súlade s legislatívou vašej krajiny, aby sa znížilo zaťaženie životného prostredia. Keď sa chcete zbaviť tohto výrobku, kontaktujte prosím distribútora alebo pobočku vo vašej krajine.

Zoznam kontaktných adries je uvedený na nasledovnej webovej stránke firmy EIZO:

www.eizoglobal.com

Pārstrādes informācija

Utilizējot šo produktu, tā savākšana un pārstrāde veicama atbilstoši jūsu valsts likumdošanas prasībām attiecībā uz slodzes uz vidi samazināšanu. Lai veiktu šī produkta utilizāciju, sazinieties ar izplatītāju vai pārstāvniecību jūsu valstī. Kontaktadreses ir norādītas zemāk minētajā EIZO tīmekļa vietnē.

www.eizoglobal.com

Informacija apie gražinamąjį perdirbimą

Šalinant (išmetant) šiuos gaminius juos reikia surinkti ir perdirbti gražinamuoju būdu pagal jūsų šalies teisės aktus, siekiant sumažinti aplinkos teršimą. Kai reikia išmesti šį gaminį, kreipkitės į jūsų šalyje veikiančią gaminių pardavimo atstovybę arba jos filialą.

Kontaktiniai adresatai nurodyti EIZO interneto svetainėje.

www.eizoglobal.com

Информация относительно рециклиране

При изхвърлянето на този продукт се предлага събирането и рециклирането му съобразно законите на вашата страна за да се намали замърсяването на околната среда. Когато искате да се освободите от този продукт, моля свържете се с търговския му представител или със съответните органи отговарящи за това във вашата страна.

Данните за връзка с нас са описани на следния Интернет сайт на EIZO:

www.eizoglobal.com

Informație referitoare la reciclare

Acest produs, când debarasat, trebuie colectat și reciclat conform legislației țării respective ca să reducem sarcina mediului. Când se debarasează de acest produs, vă rugăm să contactați un distribuitor sau un afiliat al țării respective.

Adresele de contact le găsiți pe pagina de web al EIZO:

www.eizoglobal.com

معلومات عن اعادة التدوير

عند التخلص من هذا المنتج، من الضروري تجميعه واعادة تدويره وفقاً للقوانين المتبعة في بلدك لتقليل العبء المسلط على البيئة. عندما تتخلص من هذا المنتج، يرجى الاتصال بموزع أو طرف منتسب إليه في بلدك. عناوين الاتصال مدرجة في موقع ايزو EIZO ادناه على شبكة الانترنت.

www.eizoglobal.com

Gerı Dönüşüm Bilgisi

Bu ürünün, atılacağı zaman, ülkenizin çevre kirliliğinin azaltılması konusundaki mevzuatına göre toplanması ve yeniden değerlendirilmesi gerekmektedir. Ürünü atacağınız zaman lütfen ülkenizdeki bir distribütör veya ilgili kuruluşla temasa geçiniz.

İrtibat adresleri aşağıdaki EIZO web sitesinde verilmiştir.

www.eizoglobal.com

