

User's Manual

FlexScan® L550

Color LCD Monitor

Important

Please read this User's Manual carefully to familiarize yourself with safe and effective usage procedures. Please retain this manual for future reference.



SAFETY SYMBOLS

This manual uses the safety symbols below. They denote critical information. Please read them carefully.



WARNING

Failure to abide by the information in a WARNING may result in serious injury and can be life threatening.



CAUTION

Failure to abide by the information in a CAUTION may result in moderate injury and/or property or product damage.



Indicates a prohibited action.



Indicates to ground for safety.

Copyright© 2003 by EIZO NANA O CORPORATION. All rights reserved. No part of this manual may be reproduced, stored in a retrieval system, or transmitted, in any form or by any means, electronic, mechanical, or otherwise, without the prior written permission of EIZO NANA O CORPORATION.

EIZO NANA O CORPORATION is under no obligation to hold any submitted material or information confidential unless prior arrangements are made pursuant to EIZO NANA O CORPORATION's receipt of said information. Although every effort has been made to ensure that this manual provides up-to-date information, please note that EIZO monitor specifications are subject to change without notice.

ENERGY STAR is a U.S. registered mark.

Apple and Macintosh are registered trademarks of Apple Computer, Inc.

VGA is a registered trademark of International Business Machines Corporation.

DPMS is a trademark and VESA is a registered trademark of Video Electronics Standards Association.

Windows is a registered trademark of Microsoft Corporation.

FlexScan, ScreenManager and EIZO are registered trademarks of EIZO NANA O CORPORATION.



As an ENERGY STAR® Partner, EIZO NANA O CORPORATION has determined that this product meets the ENERGY STAR guidelines for energy efficiency.

TABLE OF CONTENTS

 PRECAUTIONS	4
1. INTRODUCTION	9
1-1. Features	9
1-2. Package Contents.....	9
1-3. Controls & Connectors	10
2. CABLE CONNECTION	12
2-1. Before connecting	12
2-2. Connecting the signal cable	13
2-3. Connecting two PCs to the monitor.....	14
3. ScreenManager	15
3-1. How to use the ScreenManager	15
3-2. ScreenManager Adjustments and Settings.....	16
3-3. Useful Functions	17
4. ADJUSTMENT	18
4-1. Auto Screen Adjustment	18
4-2. Range Adjustment	18
4-3. Brightness Adjustment	19
4-4. Color Adjustment	20
4-5. Power-save Setup	21
5. ATTACHING AN ARM STAND	22
6. TROUBLESHOOTING	23
7. CLEANING	25
8. SPECIFICATIONS	26
9. GLOSSARY	28
APPENDIX/ANHANG/ANNEXE	i

⚠ PRECAUTIONS

IMPORTANT!

- This product has been adjusted specifically for use in the region to which it was originally shipped. If operated outside the region to which it was originally shipped, the product may not perform as stated in the specifications.
- To ensure personal safety and proper maintenance, please read this section and the caution statements on the unit (refer to the figure below).

[Location of the Caution Statements]

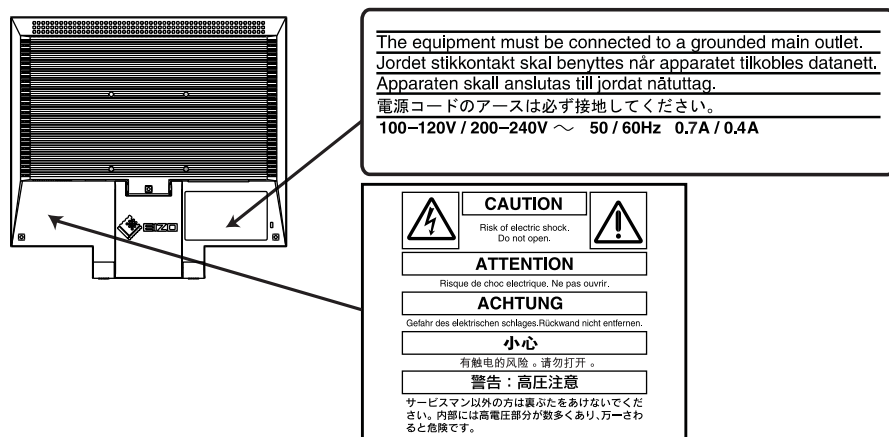

⚠ WARNING

If the unit begins to emit smoke, smells like something is burning, or makes strange noises, disconnect all power connections immediately and contact your dealer for advice.

Attempting to use a malfunctioning unit may result in fire, electric shock, or equipment damage.

Do not open the cabinet or modify the unit.

Opening the cabinet or modifying the unit may result in fire, electric shock, or burn.



Refer all servicing to qualified service personnel.

Do not attempt to service this product yourself as opening or removing covers may result in fire, electric shock, or equipment damage.

WARNING

Keep small objects or liquids away from the unit.

Small objects accidentally falling through the ventilation slots into the cabinet or spillage into the cabinet may result in fire, electric shock, or equipment damage.

If an object or liquid falls/spills into the cabinet, unplug the unit immediately. Have the unit checked by a qualified service engineer before using it again.

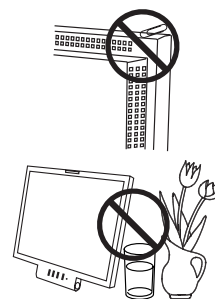

Place the unit at the strong and stable place.

A unit placed on an inadequate surface may fall and result in injury or equipment damage.

If the unit falls, disconnect the power immediately and ask your dealer for advice. Do not continue using a damaged unit. Using a damaged unit may result in fire or electric shock.

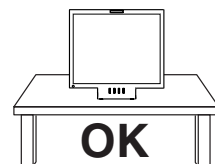

Set the unit in an appropriate location.

Not doing so may result in fire, electric shock, or equipment damage.

- * Do not place outdoors.
- * Do not place in the transportation system (ship, aircraft, trains, automobiles, etc.)
- * Do not place in a dusty or humid environment.
- * Do not place in a location where the steam comes directly on the screen.
- * Do not place near heat generating devices or a humidifier.



To avoid danger of suffocation, keep the plastic packing bags away from babies and children.



Use the enclosed power cord and connect to the standard power outlet of your country.

Be sure to remain within the rated voltage of the power cord.

Not doing so may result in fire or electric shock.

To disconnect the power cord, grasp the plug firmly and pull.

Tugging on the cord may damage and result in fire or electric shock.



The equipment must be connected to a grounded main outlet.

Not doing so may result in fire or electric shock.



WARNING

Use the correct voltage.

- * The unit is designed for use with a specific voltage only. Connection to another voltage than specified in this User's Manual may cause fire, electric shock, or equipment damage.
 - * Do not overload your power circuit, as this may result in fire or electric shock.
-

Handle the power cord with care.

- * Do not place the cord underneath the unit or other heavy objects.
- * Do not pull on or tie the cord.

If the power cord becomes damaged, stop using it. Use of a damaged cord may result in fire or electric shock.



Never touch the plug and power cord if it begins to thunder.

Touching them may result in electric shock.

When attaching an arm stand, please refer to the user's manual of the arm stand and install the unit securely with the enclosed screws.

Not doing so may cause the unit to become unattached, which may result in injury or equipment damage. When the unit is dropped, please ask your dealer for advice. Do not continue using a damaged unit. Using a damaged unit may result in fire or electric shock. When reattaching the tilt stand, please use the same screws and tighten them securely.

Do not touch a damaged LCD panel directly with bare hands.

The liquid crystal that may leak from the panel is poisonous if it enters the eyes or mouth.

If any part of the skin or body comes in direct contact with the panel, please wash thoroughly. If some physical symptoms result, please consult your doctor.



Follow local regulation or laws for safe disposal.

The backlight of the LCD panel contains mercury.

CAUTION

Handle with care when carrying the unit.

Disconnect the power cord and cables when moving the unit. Moving the unit with the cord attached is dangerous. It may result in injury.

When handling the unit, grip the bottom of the unit firmly with both hands ensuring the panel faces outward before lifting.

Dropping the unit may result in injury or equipment damage.

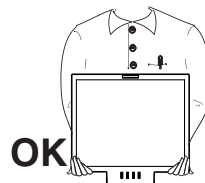

Do not block the ventilation slots on the cabinet.

- * Do not place any objects on the ventilation slots.
- * Do not install the unit in a closed space.
- * Do not use the unit laid down or upside down.

Blocking the ventilation slots prevents proper airflow and may result in fire, electric shock, or equipment damage.

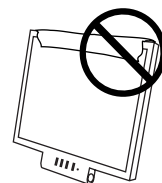

Do not touch the plug with wet hands.

Doing so may result in electrical shock.



Use an easily accessible power outlet.

This will ensure that you can disconnect the power quickly in case of a problem.

Periodically clean the area around the plug.

Dust, water, or oil on the plug may result in fire.

Unplug the unit before cleaning it.

Cleaning the unit while it is plugged into a power outlet may result in electric shock.

If you plan to leave the unit unused for an extended period, disconnect the power cord from the wall socket after turning off the power switch for the safety and the power conservation.

LCD Panel

In order to suppress the luminosity change by long-term use and to maintain the stable luminosity, use of a monitor in lower brightness is recommended.

The screen may have defective pixels. These pixels may appear as slightly light or dark area on the screen. This is due to the characteristics of the panel itself, and not the product.

The backlight of the LCD panel has a fixed life span. When the screen becomes dark or begins to flicker, please contact your dealer.

Do not press on the panel or edge of the frame strongly, as this may result in damage to the screen. There will be prints left on the screen if the pressed image is dark or black. If pressure is repeatedly applied to the screen, it may deteriorate or damage your LCD panel. Leave the screen white to decrease the prints.

Do not scratch or press on the panel with any sharp objects, such as a pencil or pen as this may result in damage to the panel. Do not attempt to brush with tissues as this may scratch the LCD panel.

1. INTRODUCTION

Thank you very much for choosing an EIZO Color Monitor.

1-1. Features

- Dual inputs compliant
- DVI (p. 28) Digital input (TMDS (p. 29)) compliant
- [Horizontal scanning frequency] Analog: 31.5 - 80 kHz, Digital: 31.5 - 64 kHz
[Vertical scanning frequency] Analog: 56 - 75.1 Hz Vertical
Digital: 59 - 61 Hz (VGA text: 69 - 71 Hz)
[Resolution] 1280 dots x 1024 lines
- Auto Screen Adjustment function incorporated (p. 18)
- BrightRegulator function incorporated (p. 19)
- Support to sRGB (p. 29) standard

1-2. Package Contents

Please contact your local dealer for assistance if any of the listed items are missing or damaged.

- | | |
|---------------------------------|---|
| • LCD Monitor | • EIZO LCD Utility Disk |
| • Power Cord | • Setup Guide |
| • Signal Cable (MD-C87) | • LIMITED WARRANTY |
| • User's Manual (in the CD-ROM) | • Mounting Screws: M4 x 12 (mm) x 4 pcs |

NOTE

- Please retain the packing materials for future transference.

1-3. Controls & Connectors

Front

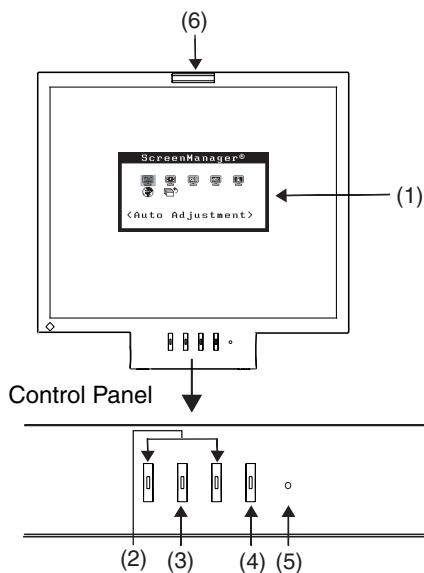

- (1) ScreenManager®
- (2) Control Buttons (Left, Right) ¹
- (3) Enter Button
- (4) Power Button
- (5) Power Indicator²

Blue	Operation
Yellow	Power saving
Off	Power off

- (6) Sensor³

¹ Pressing the Control buttons without displaying ScreenManager

Left Control Button	Switching the input signals (p. 14)
Right Control Button	Displaying the Brightness Adjustment menu (p. 19)

² Regarding the power indicator for the “Off Timer”, see p. 17.

³ When using the BrightRegulator function, the sensor detects the surrounding brightness, see p. 19.

Rear

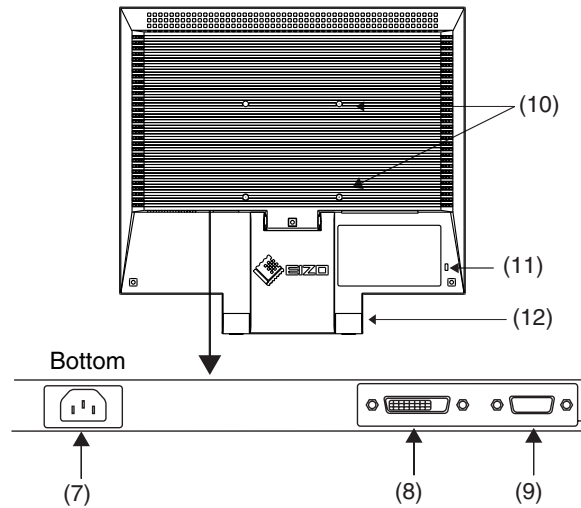

- (7) Power Connector
- (8) DVI-D Input Connector
- (9) D-Sub mini 15 pin Input Connector
- (10) 4 Holes for Mounting an Arm-Stand^{*4}
- (11) Security Lock Slot^{*5}
- (12) Stand

^{*4} The LCD monitor can be used with an optional arm stand by folding the stand, see p. 22.

^{*5} Allows for connection of a security cable. This lock supports Kensington's MicroSaver security system.

For further information, please consult:

Kensington Technology Group
 2855 Campus Drive, San Mateo, CA 94403 USA
 Tel: 800-650-4242, x3348
 Intl: 650-572-2700, x3348 / Fax: 650-572-9675
<http://www.kensington.com>

2. CABLE CONNECTION

2-1. Before connecting

Before connecting your monitor to the PC, change the display screen settings (resolution (p. 28) and frequency) in accordance with the charts below.

NOTE

- When your computer and display support VESA DDC, the suitable resolution and the refresh rate are set by just plugging your display into the computer without any manual settings.

Analog Input

Resolution	Frequency	Dot Clock	Remarks
640 x 480	~75 Hz	135 MHz (Max)	VGA, VESA
640 x 480	67 Hz		Apple Macintosh
720 x 400	70 Hz		VESA TEXT
800 x 600	~75 Hz		VESA
832 x 624	75 Hz		Apple Macintosh
1024 x 768	~75 Hz		VESA
1152 x 864	75 Hz		VESA
1152 x 870	75 Hz		Apple Macintosh
1280 x 960	60 Hz		VESA
1280 x 960	75 Hz		Apple Macintosh
1280 x 1024	~75 Hz		VESA

Digital Input

Resolution	Frequency	Dot Clock	Remarks
640 x 480	60 Hz	108 MHz (Max)	VGA
720 x 400	70 Hz		VESA TEXT
720 x 480	60 Hz		VESA Safe Mode
800 x 600	60 Hz		VESA
1024 x 768	60 Hz		VESA
1280 x 1024	60 Hz		VESA

2-2. Connecting the signal cable

NOTE

- Be sure that the Power buttons of both the PC and the monitor are OFF.

1. Set up the monitor after unfolding the base of the stand.

NOTE

- How to adjust Angles of the Monitor
Grip upper side of the monitor firmly with both hands and adjust the monitor angle as desired.

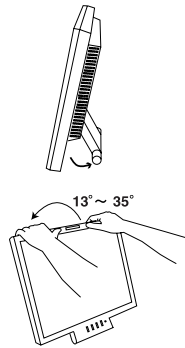

2. Plug the signal cable into the connector at the rear of the monitor and the other end of the cable into the video connector on the PC.

After connecting, secure the connection with the screw-in fasteners.

Analog Input

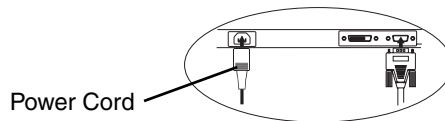

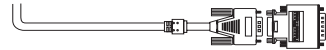
Signal Cable	Connector	PC
Signal Cable (enclosed) 	Video Output Connector D-Sub mini 15 pin	<ul style="list-style-type: none"> • Standard graphics card • Macintosh G3 (Blue & White) / Power Mac G4 (VGA)
Signal Cable (enclosed) + Macintosh Adapter (Optional) 	Video Output Connector D-Sub 15 pin	<ul style="list-style-type: none"> • Macintosh

Digital Input

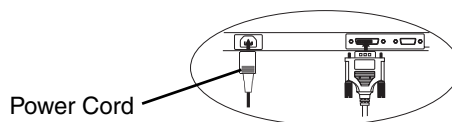

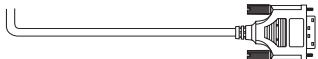
Signal Cable	Connector	PC
FD-C04/ FD-C35 / FD-C39 (Optional) 	Video Output Connector DVI	<ul style="list-style-type: none"> • Power Mac G4 (DVI) • Digital graphics card

NOTE

- The monitor is not compatible with a Power Mac G4/G4 Cube ADC (Apple Display Connector).

3. Plug the power cord into the power connector on the rear of the monitor. Then, plug the other end of the cord into a power outlet.

WARNING

Use the enclosed power cord and connect to the standard power outlet of your country.

Be sure to remain within the rated voltage of the power cord.

Not doing so may result in fire or electric shock.

The equipment must be connected to a grounded main outlet.

Not doing so may result in fire or electric shock.



4. Turn on the monitor's main power and then switch on the PC's power.

The monitor's power indicator will light up (blue).

If an image does not appear, refer to the "6. TROUBLESHOOTING" (p. 23) for advice.

Whenever finished, turn off the PC and the monitor.

NOTE

- When turning on the monitor and the computer for the first time, the Auto Screen Adjustment function will operate. (p. 18)
- Adjust Brightness of the screen depending on the brightness of your environment. Too dark or too bright of a screen can cause eyestrain. (p. 19)
- Be sure to take adequate rests. A 10-minute rest period each hour is suggested.

2-3. Connecting two PCs to the monitor

Two PCs can be connected to the monitor through the D-Sub mini 15 pin connector and the DVI connector on the back of the monitor.

Selecting the Active Input

Pressing the left control button without displaying the ScreenManager changes input signal. When switching the signal, the kind of the input signal (Analog or Digital) is displayed for a few seconds on the right top corner of the screen. When the one computer is switched off or entering the power saving mode, the monitor will automatically display the other signal.

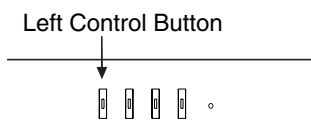

3. ScreenManager

3-1. How to use the ScreenManager

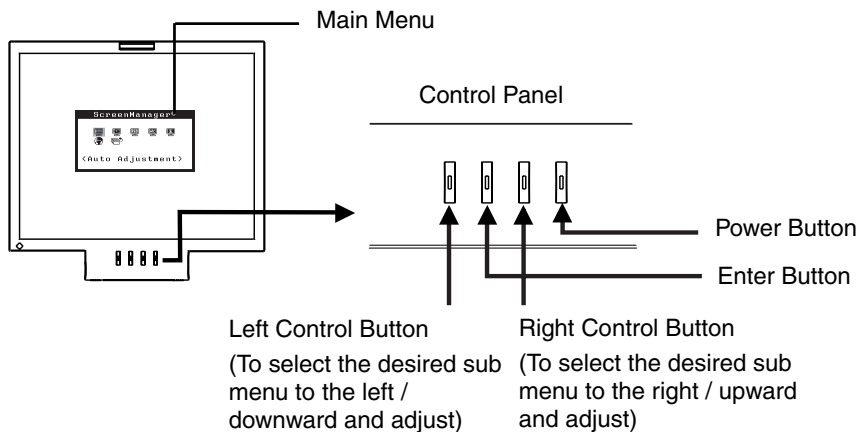

1. Entering the ScreenManager

Press the Enter button once to display the main menu of the ScreenManager.

2. Making Adjustments and Settings

- (1) Select the desired sub menu icon using the Control buttons and press the Enter button. The sub menu appears.
- (2) Use the Control buttons to select the desired setting icon and press the Enter button. The setting menu appears.
- (3) Use the Control buttons to make all required adjustments and press the Enter button to save the settings.

3. Exiting the ScreenManager

- (1) To return to the main menu, select the <Return> icon and press the Enter button.
- (2) To exit the ScreenManager, select <Exit> icon and press the Enter button.

NOTE

- Double clicking the Enter button at any time also exits the ScreenManager menu.

3-2. ScreenManager Adjustments and Settings

The following table shows all the ScreenManager's adjustment and setting menus.

“*” indicates adjustments of analog input only.

Main menu	Sub menu		Reference
Auto Adjustment	Screen	*	4-1. Auto Screen Adjustment (p. 18)
	Range	*	
Screen	Clock	*	Adjust the Clock (p. 28).
	Phase	*	Adjust the Phase (p. 28).
	Hor. Position	*	Adjust the Horizontal Position.
	Ver. Position	*	Adjust the Vertical Position.
Color	sRGB		4-4. Color Adjustment (p. 20)
	Gain		
Others	Off Timer		Set the power save. (p. 17)
	Menu Position		Adjust the menu position.
	BrightRegulator		Adjust the brightness of the screen automatically depending on the surrounding brightness. (p. 19)
	Reset		Return to the factory default settings. (p. 27)
Information	Information		Setting conditions, model name, serial number and usage time ¹
Language	English, German, French, Spanish, Italian, Swedish and Japanese		Select the ScreenManager's language.

¹ Due to the inspection on the factory, the usage time may not “0 hour” at shipping.

3-3. Useful Functions

Adjustment Lock

Use the “Adjustment Lock” function to prevent any accidental changes.

Locked function	<ul style="list-style-type: none"> • Settings in the ScreenManager
Unlocked function	<ul style="list-style-type: none"> • BrightRegulator function • Adjusting the brightness by the right control button • Switching the input signal by the left control button • Turning the power on and off by the Power button

[To lock]

- (1) Switch off the monitor’s power by the Power button.
- (2) Press on the Enter button while switching on the monitor’s power.

[To unlock]

- (1) Switch off the monitor’s power by the Power button.
- (2) Hold down the Enter button once again and turn the power back on.

Off Timer

The off timer function causes the monitor to automatically enter a power off state after a predetermined amount of time has lapsed. This function was created to reduce afterimage (p. 28) characteristics that are particular to LCD monitors when the monitor screen is left on for a long period without use.

[Procedure]

- (1) Select <Off Timer> in the ScreenManager <Others> menu.
- (2) Press the right and left buttons to adjust the “On Period” (1 to 23 hours).

[Off timer system]

PC	Monitor	Power Indicator
On Period (1H - 23H)	Operation	Blue
Last 15 min. in "On period"	Advance Notice ¹	Blue Flashing
"On period" expired	Power off	Off

¹ To delay entering the “Power Off” mode, press the Power button during the advance notice period. The monitor will continue to operate for an additional 90 minutes.

[Procedure]

Press the Power button to return to a normal screen.

NOTE

- The off timer function works while the power-save setup is active, but there is no advance notice before the monitor’s power is switched off.

4. ADJUSTMENT

Adjust the screen by referring to the followings in each input signals.

- Analog input : Adjust the screen by referring from “4-1. Auto Screen Adjustment” to “4-4. Color Adjustment”.
- Digital input : Adjust the screen by referring from “4-3. Brightness Adjustment” to “4-4. Color Adjustment”.

4-1. Auto Screen Adjustment

Screen flickering is suppressed and the proper position is adjusted automatically in the following cases.

- When the monitor is input the input signal from the computer that has never been connected the monitor.
- Changing the monitor's resolution or refresh rate

When the screen is flicking or the position is not proper.

[Procedure]

- (1) Select <Auto Adjustment> in the ScreenManager .
- (2) Select <Screen> in the sub menu and press the Enter button. The message “Auto in progress” is displayed and screen flickering is suppressed and the proper position is adjusted.

NOTE

- The screen vibrates slightly about 5 seconds during the Auto screen adjustment, but it will return to normal after adjustment.
- The Auto sizing function is intended for use on the Macintosh and on AT-compatible PC running Windows. It may not work properly in either of the following cases. When running an AT-compatible PC on MS-DOS (Not windows). The background color for the “wall paper” or “desktop” pattern is set to black.
- If the appropriate screen cannot be made by using the Auto Screen Adjustment, adjust the screen through the Screen adjustment program.

4-2. Range Adjustment (p. 28)

Please be sure to follow the following procedure to display the whole color gradation (256 colors).

[Procedure]

- (1) Select <Auto Adjustment> in the ScreenManager.
- (2) Select <Range> in the sub menu and press the Enter button.
- (3) The screen blanks for a moment and adjusts the color range to display the whole color gradation of the current output signal.

4-3. Brightness Adjustment

BrightRegulator Function

BrightRegulator function adjusts the brightness of the screen automatically depending on the surrounding brightness. The brightness of backlight is adjusted as the sensor on the upper side of the monitor detects the surrounding brightness (Default: this function is set “Enable”.)

[To deactivate this function]

- (1) Select <BrightRegulator> in the ScreenManager <Others> menu.
- (2) Select “Disable”.

NOTE

- Do not block the sensor (p.10) when using this function.

Adjusting the present brightness manually

[Procedure]

- (1) Press the Right control button without displaying the ScreenManger to display the adjusting menu.
- (2) Adjust the brightness by left and right control buttons and press the Enter button.

NOTE

- When <BrightRegulator> is set “Enable”, brightness of the screen automatically adjusted depending on the surrounding brightness based on the manual brightness adjustment.

4-4. Color Adjustment

The <Color> menu in the ScreenManager enables to change the color of the screen. In this menu, <sRGB> (p. 29) can be set and <Gain> (p. 28) can be adjusted.

In the analog input, perform the “Range Adjustment” (p. 18) before making the color adjustments.

To display the screen image based on those original colors (ex. Over the Internet)

→  Select <sRGB>.

Select “On”.

To change each color (red, green and blue)

→  Use the <Gain> (p. 28) adjustment

By adjusting the red, green and blue color tones for each mode, custom colors can be defined. The 100 % indicates unadjusted condition. Display a white or gray background image and adjust the <Gain>.

NOTE

- When the <sRGB> is set “On”, the <Gain> cannot be adjusted.
- The values shown in the percentage are available only as a reference tool.

4-5. Power-save Setup

This function reduces the power consumption when not using the computer although turning the monitor power on.

NOTE

- Do your part to conserve energy, turn off the monitor when you are finished using it. Disconnecting the monitor from the power supply is recommended to save energy completely.

Analog input

This monitor complies with the “VESA DPMS” (p. 29).

[Procedure]

Set the PC's power saving settings.

[Power saving system]

PC		Monitor	Power Indicator
Operation		Operation	Blue
Power saving	STAND-BY SUSPEND OFF	Power saving	Yellow

Operate the mouse or keyboard to return to a normal screen.

Digital input

This monitor complies with the DVI DMPM (p. 28).

[Procedure]

Set the PC's power saving settings.

[Power saving system]

PC	Monitor	Power Indicator
Operation	Operation	Blue
Power saving	Power saving	Yellow

Operate the mouse or keyboard to return to a normal screen.

5. ATTACHING AN ARM STAND

The LCD monitor can be used with an optional arm stand.

Using our optional arm or stand is recommended. (Ask your local dealer for information.)

NOTE

- If you will use the arm or stand of other manufacturers, confirm the followings to the manufacturers before selecting.
 - Hole spacing on the arm mounting: 100 mm x 100 mm (VESA compliant)
 - Supportable Weight: Total weight of the monitor (without stand) and attaching equipment such as a cable
 - TÜV/GS approved arm or stand
- Please connect cables after attaching an arm stand.

Setup Procedure

- 1.** Lay the LCD monitor down. Do not scratch the panel.
- 2.** Fold the stand. (Insert the stand firmly.)
- 3.** Attach an arm stand to the LCD monitor securely.

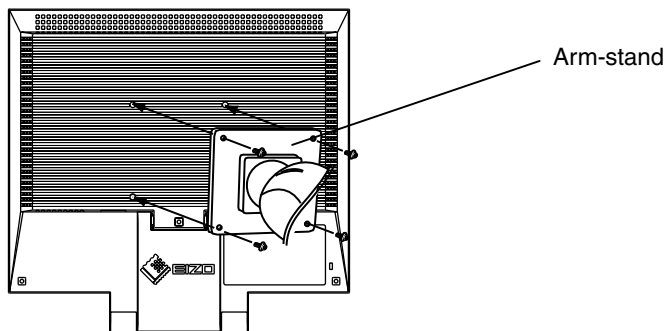

4 Mounting Screws (enclosed): M4 x 12 mm

6. TROUBLESHOOTING

If a problem persists even after applying the suggested remedies, contact an EIZO dealer.

- No picture problems : See No.1 ~ No.2
- Imaging problems : See No.3 ~ No.8
- Other problems : See No.9

Problems	Points to check with possible solutions
<p>1. No picture</p> <ul style="list-style-type: none"> • Indicator status: Off <hr/> <ul style="list-style-type: none"> • Indicator status: Blue <hr/> <ul style="list-style-type: none"> • Indicator status: Yellow 	<ul style="list-style-type: none"> <input type="checkbox"/> Check that the power cord is correctly connected. If the problem persists, turn off the monitor power for a few minutes, then turn it back on and try again. <hr/> <ul style="list-style-type: none"> <input type="checkbox"/> Check the Brightness setting. (p. 19) <input type="checkbox"/> Switch the signal input. Pressing the left control button without displaying the ScreenManager changes input signal. (p. 14) <input type="checkbox"/> Try pressing a key on the keyboard, or clicking the mouse. (p. 21)
<p>2. Following messages appear. (Error messages shown below will remain on the screen for 40 seconds.)</p> <div data-bbox="223 1039 563 1219" style="border: 2px solid black; padding: 5px; margin: 10px 0;"> <p style="text-align: center;">Signal Check</p> <p style="text-align: center;">Analog</p> <p style="text-align: center;">No Signal</p> </div> <ul style="list-style-type: none"> • Whenever an error signal message appears, the signal frequency will be displayed in red. (Example) <div data-bbox="219 1479 568 1661" style="border: 2px solid black; padding: 5px; margin: 10px 0;"> <p style="text-align: center;">Signal Error</p> <p style="text-align: center;">Digital</p> <p style="text-align: center;">fD: 70.0MHz</p> <p style="text-align: center;">fH: 40.0kHz</p> <p style="text-align: center;">fU: 60.0Hz</p> </div>	<ul style="list-style-type: none"> <input type="checkbox"/> These messages appear when the signal is not inputted correctly, even if the monitor functions properly. <input type="checkbox"/> When the image is displayed correctly after a short time, there is no problem with the monitor. (Some PCs do not output the signal soon after powering on.) <input type="checkbox"/> Check that the PC is turned ON. <input type="checkbox"/> Check that the signal cable is properly connected to the PC or graphics board. <input type="checkbox"/> Switch the signal input. Pressing the left control button without displaying the ScreenManager changes input signal. (p. 14) <hr/> <ul style="list-style-type: none"> <input type="checkbox"/> Use the graphics board's utility software to change the frequency setting. (Refer to the manual of the graphics board.)

Problems	Points to check with possible solutions
<p>3. Display position is incorrect.</p> 	<ul style="list-style-type: none"> <input type="checkbox"/> Adjust the image position using the <Hor.Position> and <Ver.Position> (p. 16) <input type="checkbox"/> If the problem persists, use the graphics board's utility software to change the display position if available.
<p>4. The screen is too bright or too dark.</p>	<ul style="list-style-type: none"> <input type="checkbox"/> Adjust the Brightness (p. 19) (The baklight of the LCD monitor has a fixed life span. When the screen becomes dark or begins to flicker, please consult your dealer.)
<p>5. Afterimages appear.</p>	<ul style="list-style-type: none"> <input type="checkbox"/> When the screen image is changed after displaying the same image for a long period, an afterimage may appear. The "Afterimage" can be removed gradually by changing the displayed image. Use the "Off Timer" function and avoid keeping the screen on all the time. (p. 17)
<p>6. The screen has defective pixels (e.g. slightly light or dark).</p>	<ul style="list-style-type: none"> <input type="checkbox"/> This is due to the characteristics of the panel itself, and not the LCD product.
<p>7. Fingerprints remain on the screen.</p>	<ul style="list-style-type: none"> <input type="checkbox"/> Leaving the screen white may solve the problem.
<p>8. The screen is flicking or the position is not proper.</p>	<ul style="list-style-type: none"> <input type="checkbox"/> Select the <Screen> in the ScreenManager <Auto Adjustment> menu. (p. 18)
<p>9. The Enter button does not operate.</p>	<ul style="list-style-type: none"> <input type="checkbox"/> The adjustment lock is probably on. To unlock: switch the LCD monitor off. Then, while pressing the Enter, switch the power on. (p. 17)

7. CLEANING

Periodic cleaning is recommended to keep the monitor looking new and to prolong its operation lifetime.

NOTE

- Never use thinner, benzene, alcohol (ethanol, methanol, or isopropyl alcohol), abrasive cleaners, or other strong solvents, as these may cause damage to the cabinet or LCD panel.

Cabinet

To remove stains, wipe the cabinet with a soft, lightly moistened cloth using a mild detergent. Do not spray wax or cleaner directly into the cabinet. (For details, refer to the manual of the PC.)

LCD Panel

- The LCD surface can be cleaned with a soft cloth, such as cotton or lens paper.
- If necessary, stubborn stains can be removed by moistening part of a cloth with water to enhance its cleaning power.

8. SPECIFICATIONS

LCD Panel	43.2 cm (17.0 inch), TFT color LCD panel with Anti-Glare Hard Coating Viewing Angle: H: 140°, V: 140°
Dot Pitch	0.264 mm
Horizontal Scan Frequency	Analog: 31.5 ~ 80 kHz (Automatic) Digital: 31.5 ~ 64 kHz
Vertical Scan Frequency	Analog: 56 Hz ~ 75.1 Hz (Automatic) Digital: 59 ~ 61 Hz, (VGA Text : 69 ~ 71 Hz)
Resolution	1280 dots x 1024 lines
Dot Clock (Max.)	Analog: 135 MHz, Digital: 108 MHz
Display Colors	16 million colors (max.)
Display Area	337 mm (H) x 270 mm (V) (13.3" (H) x 10.6" (V)) (Viewable image size: 432 mm (17.0"))
Power Supply	100-120/200-240 VAC±10%, 50/60 Hz, 0.7 A/0.4 A
Power Consumption	Max.: 38 W Power Saving Mode: Less than 2 W
Input Connector	D-Sub mini 15 pin, DVI-D
Analog Input Signal (Sync)	Separate, TTL, Positive/Negative
Input Signal (Digital)	TMDS (Single Link)
Signal registration	Analog: 30 (Factory preset: 20)
Plug & Play	VESA DDC 2B
Dimensions	369 mm (W) x 298 ~ 344.5 mm (H) x 120.5 ~ 222.5 mm (D) (14.5"(W) x 11.7 ~ 13.6"(H) x 4.7 ~ 8.8"(D))
Dimensions (folding stand)	369 mm (W) x 350.5 mm (H) x 52 mm (D) (14.5"(W) x 13.8"(H) x 2.05"(D))
Weight	3.9 kg (8.6 lbs.)
Temperature	Operating: 0 °C ~ 35 °C (32 °F ~ 95 °F) Storage: -20 °C ~ 60 °C (-4 °F ~ 140 °F) Humidity 30% to 80% R.H. Non-condensing
Certifications and Standards	
100-120 VAC	NRTL/C-TÜV, FCC-B, TCO'03 ¹ , TCO'99 ² , EPA ENERGY STAR Program, TÜV/Rheinland Ergonomics Approved
200-240 VAC	
	CE, CB, TÜV Rheinland/GS, TCO'03 ¹ , TCO'99 ² , EPA ENERGY STAR Program, TÜV/Rheinland Ergonomics Approved

¹ Gray Version / Two-tone color (gray & black) Version

² Black Version

Default settings

	Analog input	Digital input
Brightness		100%
sRGB		Off
Gain		100%
Off Timer		Disable
Menu Position		Center
BrightRegulator		Enable
Language		English

Dimensions

Unit mm (inches)

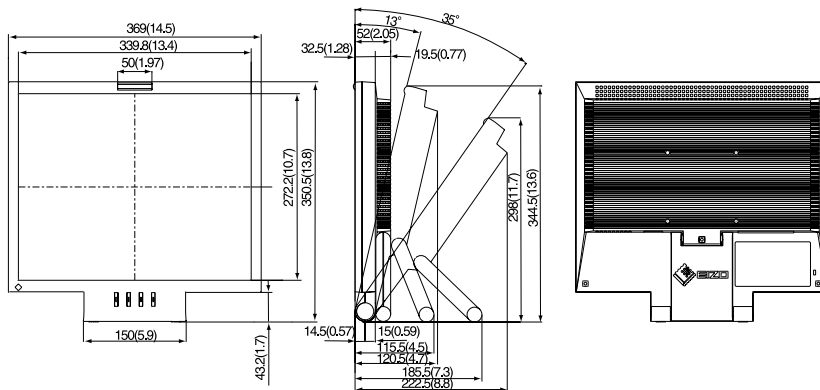

Pin Assignment

D-Sub mini 15 pin connector

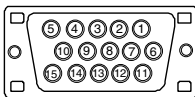

Pin No.	Signal	Pin No.	Signal	Pin No.	Signal
1	Red video	6	Red ground	11	Ground Shorted
2	Green video	7	Green ground	12	Data (SDA)
3	Blue video	8	Blue ground	13	H. Sync
4	Ground	9	No pin	14	V. Sync
5	No pin	10	Ground Shorted	15	Clock (SCL)

DVI-D Connector

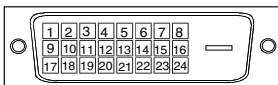

Pin No.	Signal	Pin No.	Signal	Pin No.	Signal
1	TMDS Data2-	9	TMDS Data1-	17	TMDS Data0-
2	TMDS Data2+	10	TMDS Data1+	18	TMDS Data0+
3	TMDS Data2/4 Shield	11	TMDS Data1/3 Shield	19	TMDS Data0/5 Shield
4	NC*	12	NC	20	NC
5	NC	13	NC	21	NC
6	DDC Clock (SCL)	14	+5V Power	22	TMDS Clock shield
7	DDC Data (SDA)	15	Ground (For +5V)	23	TMDS Clock+
8	Analog Vertical Sync	16	Hot Plug Detect	24	TMDS Clock-

(*NC: No Connection)

9. GLOSSARY

Afterimage

The Afterimage is particular to LCD monitors when the monitor screen is left on for a long period without use. The “Afterimage” can be removed gradually by changing the displayed image.

Clock

With the analog input signal display, the analog signal is converted to a digital signal by the LCD circuitry. To convert the signal correctly, the LCD monitor needs to produce the same number clock pulse as the dot clock of the graphics system. When the clock pulse is not correctly set, some vertical bars of distortion are displayed on the screen.

DVI

(Digital Visual Interface)

A digital flat panel interface. DVI can transmit digital data from the PC directly without loss with the signal transition method “TMDS”.

There are two kinds of DVI connectors. One is DVI-D connector for digital signal input only. The other is DVI-I connector for both digital and analog signal inputs.

DVI DMPM

(DVI Digital Monitor Power Management)

The Power management system for the digital interface. The “Monitor ON” status (operation mode) and the “Active Off” status (power-saving mode) are indispensable for the DVI-DMPM as the monitor’s power mode.

Gain Adjustment

Adjusts each color parameter for red, green and blue. The color of the LCD monitor is displayed through the color filter of the LCD panel. Red, green and blue are the three primary colors. The colors on the monitor are displayed by combining these three colors. The color tone can change by adjusting the illumination amount passed through each color’s filter.

Phase

The phase adjustment decides the sampling timing point for converting the analog input signal to a digital signal. Adjusting the phase after the clock adjustment will produce a clear screen.

Range Adjustment

The Range Adjustment controls the level of output signal range to display the whole color gradation.

Resolution

The LCD panel consists of a fixed number of pixel elements which are illuminated to form the screen image. The EIZO L550 display panel consists of 1280 horizontal pixels and 1024 vertical pixels. At a resolution of 1280 x 1024, all pixels are displayed as a full screen.

sRGB (Standard RGB)

“International Standard for Red, Green, and Blue color space”

A color space was defined with the aim of the color matching between applications and hardware devices, such as monitors, scanners, printers and digital cameras. As a standard default space, sRGB allows Internet users to closely match colors.

TMDS

(Transition Minimized Differential Signaling)

A signal transition method for the digital interface.

VESA DPMS

(Video Electronics Standards Association - Display Power Management Signaling)

The acronym VESA stands for “Video Electronics Standards Association” and DPMS stands for “Display Power Management Signaling”. DPMS is a communication standard that PCs and graphics boards use to implement power savings on the monitor side.

APPENDIX/ANHANG/ANNEXE

Preset Timing Chart for Analog input Timing-Übersichten für Analog Eingang Synchronisation des Signaux pour Analog numerique

Based on the signal diagram shown below 19 factory presets have been registered in the monitor's microprocessor.

Der integrierte Mikroprozessor des Monitors unterstützt 19 werkseitige Standardeinstellungen (siehe hierzu die nachfolgenden Diagramme).

19 signaux ont été enregistrés en usine dans le microprocesseur du moniteur, conformément au diagramme de synchronisation ci-dessous.

Mode	Dot Clock MHz	Frequencies		Sync Polarity	
		H kHz	V Hz	H	V
VGA 640 × 480 @60 Hz	25.175	31.47	59.94	Nega.	Nega.
VGA 720 × 400 @70 Hz	28.322	31.47	70.09	Nega.	Posi.
Macintosh 640 × 480 @67 Hz	30.240	35.00	66.67	Nega.	Nega.
Macintosh 832 × 624 @75 Hz	57.280	49.72	74.55	Posi.	Posi.
Macintosh 1152 × 870 @75 Hz	100.000	68.68	75.06	Nega.	Nega.
Macintosh 1280 × 960 @75 Hz	126.200	74.76	74.76	Posi.	Posi.
VESA 640 × 480 @73 Hz	31.500	37.86	72.81	Nega.	Nega.
VESA 640 × 480 @75 Hz	31.500	37.50	75.00	Nega.	Nega.
VESA 800 × 600 @56 Hz	36.000	35.16	56.25	Posi.	Posi.
VESA 800 × 600 @60 Hz	40.000	37.88	60.32	Posi.	Posi.
VESA 800 × 600 @72 Hz	50.000	48.08	72.19	Posi.	Posi.
VESA 800 × 600 @75 Hz	49.500	46.88	75.00	Posi.	Posi.
VESA 1024 × 768 @60 Hz	65.000	48.36	60.00	Nega.	Nega.
VESA 1024 × 768 @70 Hz	75.000	56.48	70.07	Nega.	Nega.
VESA 1024 × 768 @75 Hz	78.750	60.02	75.03	Posi.	Posi.
VESA 1152 × 864 @75 Hz	108.000	67.50	75.00	Posi.	Posi.
VESA 1280 × 960 @60 Hz	108.000	60.00	60.00	Posi.	Posi.
VESA 1280 × 1024 @60 Hz	108.000	63.98	60.02	Posi.	Posi.
VESA 1280 × 1024 @75 Hz	135.000	79.98	75.03	Posi.	Posi.

[Applicable to gray cabinet version only.]



Congratulations!

The display you have just purchased carries the TCO'03 Displays label. This means that your display is designed, manufactured and tested according to some of the strictest quality and environmental requirements in the world. This makes for a high performance product, designed with the user in focus that also minimizes the Impact on our natural environment.

Some of the features of the TCO'03 Display requirements:

Ergonomics

- Good visual ergonomics and image quality in order to improve the working environment for the user and to reduce sight and strain problems. Important parameters are luminance, contrast, resolution, reflectance, colour rendition and image stability.

Energy

- Energy-saving mode after a certain time – beneficial both for the user and environment
- Electrical safety
- Emissions
Electromagnetic fields
- Noise emissions

Ecology

- The products must be prepared for recycling and the manufacturer must have a certified environmental management system such as EMAS or ISO 14000
- Restrictions on
 - chlorinated and brominated flame retardants and polymers
 - heavy metals such as cadmium, mercury and lead.

The requirements included in this label have been developed by TCO Development in co-operation with scientists, experts, users as well as manufacturers all over the world. Since the end of the 1980s TCO has been involved in influencing the development of IT equipment in a more user-friendly direction. Our labeling system with displays in 1992 and is now requested by users and IT-manufacturers all over the world.

For more information, please visit
www.tcodevelopment.com

[Applicable to black cabinet version only]



Congratulations!

You have just purchased a TCO'99 approved and labelled product! Your choice has provided you with a product developed for professional use. Your purchase has also contributed to reducing the burden on the environment and also to the further development of environmentally adapted electronics products.

Why do we have environmentally labelled computers?

In many countries, environmental labelling has become an established method for encouraging the adaptation of goods and services to the environment. The main problem, as far as computers and other electronics equipment are concerned, is that environmentally harmful substances are used both in the products and during their manufacture. Since it is not so far possible to satisfactorily recycle the majority of electronics equipment, most of these potentially damaging substances sooner or later enter nature.

There are also other characteristics of a computer, such as energy consumption levels, that are important from the viewpoints of both the work (internal) and natural (external) environments. Since all methods of electricity generation have a negative effect on the environment (e.g. acidic and climate-influencing emissions, radioactive waste), it is vital to save energy. Electronics equipment in offices is often left running continuously and thereby consumes a lot of energy.

What does labelling involve?

This product meets the requirements for the TCO'99 scheme which provides for international and environmental labelling of personal computers. The labelling scheme was developed as a joint effort by the TCO (The Swedish Confederation of Professional Employees), Svenska Naturskyddsforeningen (The Swedish Society for Nature Conservation) and Statens Energimyndighet (The Swedish National Energy Administration).

Approval requirements cover a wide range of issues: environment, ergonomics, usability, emission of electric and magnetic fields, energy consumption and electrical and fire safety.

The environmental demands impose restrictions on the presence and use of heavy metals, brominated and chlorinated flame retardants, CFCs (freons) and chlorinated solvents, among other things. The product must be prepared for recycling and the manufacturer is obliged to have an environmental policy which must be adhered to in each country where the company implements its operational policy.

The energy requirements include a demand that the computer and/or display, after a certain period of inactivity, shall reduce its power consumption to a lower level in one or more stages. The length of time to reactivate the computer shall be reasonable for the user.

Labelled products must meet strict environmental demands, for example, in respect of the reduction of electric and magnetic fields, physical and visual ergonomics and good usability.

You will find a brief summary of the environmental requirements met by this product on the right. The complete environmental criteria document may be ordered from:

TCO Development

SE-114 94 Stockholm, Sweden

Fax: +46 8 782 92 07

Email (Internet): development@tco.se

Current information regarding TCO'99 approved and labelled products may also be obtained via the Internet, using the address: <http://www.tco-info.com/>

Environmental Requirements

Flame retardants

Flame retardants are present in printed circuit boards, cables, wires, casings and housings. Their purpose is to prevent, or at least to delay the spread of fire. Up to 30% of the plastic in a computer casing can consist of flame retardant substances. Most flame retardants contain bromine or chloride, and those flame retardants are chemically related to another group of environmental toxins, PCBs. Both the flame retardants containing bromine or chloride and the PCBs are suspected of giving rise to severe health effects, including reproductive damage in fish-eating birds and mammals, due to the bio-accumulative* processes. Flame retardants have been found in human blood and researchers fear that disturbances in foetus development may occur.

The relevant TCO'99 demand requires that plastic components weighing more than 25 grams must not contain flame retardants with organically bound bromine or chlorine. Flame retardants are allowed in the printed circuit boards since no substitutes are available.

Cadmium**

Cadmium is present in rechargeable batteries and in the colour-generating layers of certain computer displays. Cadmium damages the nervous system and is toxic in high doses.

The relevant TCO'99 requirement states that batteries, the colour-generating layers of display screens and the electrical or electronics components must not contain any cadmium.

Mercury**

Mercury is sometimes found in batteries, relays and switches. It damages the nervous system and is toxic in high doses.

The relevant TCO'99 requirement states that batteries may not contain any mercury. It also demands that mercury is not present in any of the electrical or electronics components associated with the labelled unit.

CFCs (freons)

The relevant TCO'99 requirement states that neither CFCs nor HCFCs may be used during the manufacture and assembly of the product. CFCs (freons) are sometimes used for washing printed circuit boards. CFCs break down ozone and thereby damage the ozone layer in the stratosphere, causing increased reception on earth of ultraviolet light with e.g. increased risks of skin cancer (malignant melanoma) as a consequence.

Lead**

Lead can be found in picture tubes, display screens, solders and capacitors. Lead damages the nervous system and in higher doses, causes lead poisoning.

The relevant TCO'99 requirement permits the inclusion of lead since no replacement has yet been developed.

* Bio-accumulative is defined as substances which accumulate within living organisms.

** Lead, Cadmium and Mercury are heavy metals which are Bio-accumulative.

For U.S.A, Canada, etc. (rated 100-120 Vac) Only

FCC Declaration of Conformity

We, the Responsible Party EIZO NANA O TECHNOLOGIES INC.
5710 Warland Drive, Cypress, CA 90630
Phone: (562) 431-5011

declare that the product Trade name: EIZO
Model: FlexScan L550

is in conformity with Part 15 of the FCC Rules. Operation of this product is subject to the following two conditions: (1) this device may not cause harmful interference, and (2) this device must accept any interference received, including interference that may cause undesired operation.

This equipment has been tested and found to comply with the limits for a Class B digital device, pursuant to Part 15 of the FCC Rules. These limits are designed to provide reasonable protection against harmful interference in a residential installation. This equipment generates, uses, and can radiate radio frequency energy and, if not installed and used in accordance with the instructions, may cause harmful interference to radio communications. However, there is no guarantee that interference will not occur in a particular installation. If this equipment does cause harmful interference to radio or television reception, which can be determined by turning the equipment off and on, the user is encouraged to try to correct the interference by one or more of the following measures.

- * Reorient or relocate the receiving antenna.
- * Increase the separation between the equipment and receiver.
- * Connect the equipment into an outlet on a circuit different from that to which the receiver is connected.
- * Consult the dealer or an experienced radio/TV technician for help.

Changes or modifications not expressly approved by the party responsible for compliance could void the user's authority to operate the equipment.

Note

Use the attached specified cable below or EIZO signal cable with this monitor so as to keep interference within the limits of a Class B digital device.

- AC Cord
- Shielded Signal Cable (D-SUB mini 15 pin - D-SUB mini 15 pin, the enclosed signal cable)
- Stereo mini-jack cable

Canadian Notice

This Class B digital apparatus complies with Canadian ICES-003.
Cet appareil numérique de la classe B est conforme à la norme NMB-003 du Canada.

Recycle Auskunft

Die Rücknahme dieses Produktes nach Nutzungsende übernimmt EIZO in Deutschland zusammen mit dem Partner von Roll MBB Recycling GmbH. Dort werden die Geräte in ihre Bestandteile zerlegt, die dann der Wiederverwertung zugeführt werden. Um einen Abholtermin zu vereinbaren und die aktuellen Kosten zu erfahren, benutzen Sie bitte folgende Rufnummer: 02153-73 35 00. Weitere Informationen finden Sie auch unter der Internet-Adresse: www.eizo.de.

Recycling Information for customers in Switzerland:

All recycling information is placed in the SWICO's website.
<http://www.swico.ch>

Recycling-Information für Kunden in der Schweiz:

Alle Informationen zum Thema Recycling finden Sie auf der Homepage des Branchenverbandes SWICO.
<http://www.swico.ch>

Renseignements de recyclage pour les clients en Suisse:

Vous trouvez tous les renseignements pour le sujet de recyclage sur la page WEB de l'UNION DE BRAN CHE SWICO.
<http://www.eizo.com/cotact/index.html>

Recycling Information for customers in USA:

All recycling information is placed in the EIZO Nanao Technologies, Inc's website.
<http://www.eizo.com/contact/index.html>

Återvinnings information för kunder i Sverige:

All information om återvinning finns på Eizo Nordics hemsida:
www.eizo.se



EIZO NANO CORPORATION

153 Shimokashiwano, Matto, Ishikawa 924-8566 Japan
Phone: +81 76 277 6792 Fax: +81 76 277 6793

EIZO NANO TECHNOLOGIES INC.

5710 Warland Drive, Cypress, CA 90630
Phone: +1 562 431 5011 Fax: +1 562 431 4811

<http://www.eizo.com/>



2nd Edition-November, 2003 Printed in Japan.

03V20570B1
(FA-1785)